

*Projector*

**6752WU/6752WUA/6757W/  
6757WA/6762/6762A/6762WU/  
6762WUA/6767W/6767WA/  
6772/6772A**

---

*User's Manual*

- Apple, Mac, Mac OS, and MacBook are trademarks of Apple Inc. registered in the U.S. and other countries.
- Microsoft, Windows, Windows Vista, Internet Explorer, .NET Framework and PowerPoint are either a registered trademark or trademark of Microsoft Corporation in the United States and/or other countries.
- MicroSaver is a registered trademark of Kensington Computer Products Group, a division of ACCO Brands.
- Adobe, Adobe PDF, Adobe Reader, and Acrobat are either registered trademarks or trademarks of Adobe Systems Incorporated in the United States and/or other countries.
- Virtual Remote Tool uses WinI2C/DDC library, © Nicomsoft Ltd.
- HDMI, the HDMI Logo and High-Definition Multimedia Interface are trademarks or registered trademarks of HDMI Licensing LLC.



- DisplayPort and DisplayPort Compliance Logo are trademarks owned by the Video Electronics Standards Association.



- HDBaseT™ is a trademark of HDBaseT Alliance.



- Trademark PLink is a trademark applied for trademark rights in Japan, the United States of America and other countries and areas.
- Wi-Fi®, Wi-Fi Alliance®, and Wi-Fi Protected Access (WPA, WPA2)® are registered trademarks of the Wi-Fi Alliance.
- Blu-ray is a trademark of Blu-ray Disc Association.
- CRESTRON and ROOMVIEW are registered trademarks of Crestron Electronics, Inc. in the United States and other countries.
- Ethernet is either a registered trademark or trademark of Fuji Xerox Co., Ltd.
- Other product and company names mentioned in this user's manual may be the trademarks or registered trademarks of their respective holders.
- TOPPERS Software Licenses

The product includes software licensed under TOPPERS License.

For more information on each software, see "readme.pdf" inside the "about TOPPERS" folder on the supplied CD-ROM.

## NOTES

- (1) The contents of this user's manual may not be reprinted in part or whole without permission.
- (2) The contents of this user's manual are subject to change without notice.
- (3) Great care has been taken in the preparation of this user's manual; however, should you notice any questionable points, errors or omissions, please contact us.
- (4) Notwithstanding article (3), we will not be responsible for any claims on loss of profit or other matters deemed to result from using the PROJECTOR.

# Important Information

## Safety Cautions

### Precautions

Please read this manual carefully before using your projector and keep the manual handy for future reference. This manual is a common User's Manual for the following models 1 and 2. The explanation in the manual is based mainly on the 6762WUA model. In this manual, some of the descriptions in the following two types of model group names have been replaced due to differences in the basic functions of the projectors.

1. The following models are described as [HDBaseT Models].

6762WUA/6752WUA/6767WA/6757WA/6772A/6762A

2. The following models are described as [MM Models].

6762WU/6752WU/6767W/6757W/6772/6762

#### CAUTION



To turn off main power, be sure to remove the plug from power outlet.

The power outlet socket should be installed as near to the equipment as possible, and should be easily accessible.

#### CAUTION



TO PREVENT SHOCK, DO NOT OPEN THE CABINET.  
THERE ARE HIGH-VOLTAGE COMPONENTS INSIDE.  
REFER SERVICING TO QUALIFIED SERVICE PERSONNEL.



This symbol warns the user that uninsulated voltage within the unit may be sufficient to cause electrical shock. Therefore, it is dangerous to make any kind of contact with any part inside of the unit.



This symbol alerts the user that important information concerning the operation and maintenance of this unit has been provided.

The information should be read carefully to avoid problems.

**WARNING:** TO PREVENT FIRE OR SHOCK, DO NOT EXPOSE THIS UNIT TO RAIN OR MOISTURE.  
DO NOT USE THIS UNIT'S PLUG WITH AN EXTENSION CORD OR IN AN OUTLET UNLESS ALL THE PRONGS CAN BE FULLY INSERTED.

### DOC Compliance Notice (for Canada only)

This Class B digital apparatus complies with Canadian ICES-003.

### Machine Noise Information Regulation - 3. GPSGV,

The highest sound pressure level is less than 70 dB (A) in accordance with EN ISO 7779.

#### CAUTION



Avoid displaying stationary images for a prolonged period of time.

Doing so can result in these images being temporarily sustained on the surface of the LCD panel.

If this should happen, continue to use your projector. The static background from previous images will disappear.

### Disposing of your used product



EU-wide legislation as implemented in each Member State requires that used electrical and electronic products carrying the mark (left) must be disposed of separately from normal household waste. This includes projectors and their electrical accessories or lamps. When you dispose of such products, please follow the guidance of your local authority and/or ask the shop where you purchased the product.

After collecting the used products, they are reused and recycled in a proper way. This effort will help us reduce the wastes as well as the negative impact such as mercury contained in a lamp to the human health and the environment at the minimum level.

The mark on the electrical and electronic products only applies to the current European Union Member States.

### WARNING TO CALIFORNIA RESIDENTS:

Handling the cables supplied with this product will expose you to lead, a chemical known to the State of California to cause birth defects or other reproductive harm. WASH HANDS AFTER HANDLING.

### RF Interference (for USA only)

#### WARNING

The Federal Communications Commission does not allow any modifications or changes to the unit EXCEPT those specified by Dukane Audio Visual Division, in this manual. Failure to comply with this government regulation could void your right to operate this equipment. This equipment has been tested and found to comply with the limits for a Class B digital device, pursuant to Part 15 of the FCC Rules. These limits are designed to provide reasonable protection against harmful interference in a residential installation. This equipment generates, uses, and can radiate radio frequency energy and, if not installed and used in accordance with the instructions, may cause harmful interference to radio communications. However, there is no guarantee that interference will not occur in a particular installation.

If this equipment does cause harmful interference to radio or television reception, which can be determined by turning the equipment off and on, the user is encouraged to try to correct the interference by one or more of the following measures:

- Reorient or relocate the receiving antenna.
- Increase the separation between the equipment and receiver.
- Connect the equipment into an outlet on a circuit different from that to which the receiver is connected.
- Consult the dealer or an experienced radio / TV technician for help.

For UK only: In UK, a BS approved power cord with moulded plug has a Black (five Amps) fuse installed for use with this equipment. If a power cord is not supplied with this equipment please contact your supplier.

### Important Safeguards

These safety instructions are to ensure the long life of your projector and to prevent fire and shock. Please read them carefully and heed all warnings.

#### Installation

- Do not place the projector in the following conditions:
  - on an unstable cart, stand, or table.
  - near water, baths, or damp rooms.
  - in direct sunlight, near heaters, or heat radiating appliances.
  - in a dusty, smoky or steamy environment.
  - on a sheet of paper or cloth, rugs or carpets.
- If you wish to have the projector installed on the ceiling:
  - Do not attempt to install the projector yourself.
  - The projector must be installed by qualified technicians in order to ensure proper operation and reduce the risk of bodily injury.
  - In addition, the ceiling must be strong enough to support the projector and the installation must be in accordance with any local building codes.
  - Please consult your dealer for more information.

### WARNING

- Do not cover the lens with the lens cap or equivalent while the projector is on. Doing so can lead to melting of the cap due to the heat emitted from the light output.
- Do not place any objects, which are easily affected by heat, in front of the projector lens. Doing so could lead to the object melting from the heat that is emitted from the light output.



Do not use the projector with it leaning to the left and right. This may result in a malfunction. However, portrait installation is possible\* (when a custom-designed stand is made). For portrait installation, install the projector with the intake vent at the bottom and leave a space of at least 130 mm below the intake vent.

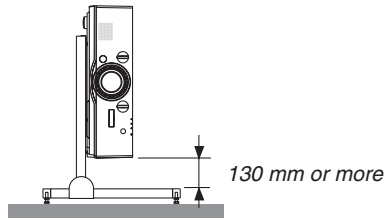
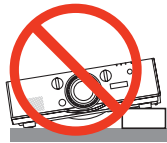

### ⚠ Fire and Shock Precautions ⚠

- Ensure that there is sufficient ventilation and that vents are unobstructed to prevent the build-up of heat inside your projector. Allow enough space between your projector and a wall. (→ page vii)
- Do not try to touch the exhaust vents on the left rear and the rear (when seen from the front) as it can become heated while the projector is turned on and immediately after the projector is turned off. Parts of the projector may become temporarily heated if the projector is turned off with the POWER button or if the AC power supply is disconnected during normal projector operation.  
Use caution when picking up the projector.



- Prevent foreign objects such as paper clips and bits of paper from falling into your projector. Do not attempt to retrieve any objects that might fall into your projector. Do not insert any metal objects such as a wire or screwdriver into your projector. If something should fall into your projector, disconnect it immediately and have the object removed by a qualified service personnel.
- Do not place any objects on top of the projector.
- Do not touch the power plug during a thunderstorm. Doing so can cause electrical shock or fire.
- The projector is designed to operate on a power supply of 100-240V AC 50/60 Hz. Ensure that your power supply fits this requirement before attempting to use your projector.
- Do not look into the lens while the projector is on. Serious damage to your eyes could result.



- Keep any items (magnifying glass etc.) out of the light path of the projector. The light path being projected from the lens is extensive, therefore any kind of abnormal objects that can redirect light coming out of the lens, can cause an unpredictable outcome such as a fire or injury to the eyes.
- Do not place any objects, which are easily affected by heat, in front of a projector exhaust vent. Doing so could lead to the object melting or getting your hands burned from the heat that is emitted from the exhaust vent.

- Handle the power cord carefully. A damaged or frayed power cord can cause electric shock or fire.
  - Do not use any power cord other than the one supplied with the projector.
  - Do not bend or tug the power cord excessively.
  - Do not place the power cord under the projector, or any heavy object.
  - Do not cover the power cord with other soft materials such as rugs.
  - Do not heat the power cord.
  - Do not handle the power plug with wet hands.
- Turn off the projector, unplug the power cord and have the projector serviced by a qualified service personnel under the following conditions:
  - When the power cord or plug is damaged or frayed.
  - If liquid has been spilled into the projector, or if it has been exposed to rain or water.
  - If the projector does not operate normally when you follow the instructions described in this user's manual.
  - If the projector has been dropped or the cabinet has been damaged.
  - If the projector exhibits a distinct change in performance, indicating a need for service.
- Disconnect the power cord and any other cables before carrying the projector.
- Turn off the projector and unplug the power cord before cleaning the cabinet or replacing the lamp.
- Turn off the projector and unplug the power cord if the projector is not to be used for an extended period of time.
- When using a LAN cable:  
For safety, do not connect to the connector for peripheral device wiring that might have excessive voltage.

### CAUTION

- Do not use the tilt-foot for purposes other than originally intended. Misuses such as gripping the tilt-foot or hanging on the wall can cause damage to the projector.
- Do not send the projector in the soft case by parcel delivery service or cargo shipment. The projector inside the soft case could be damaged.
- Select [HIGH] in Fan mode if you continue to use the projector for consecutive days. (From the menu, select [SETUP] → [OPTIONS(1)] → [FAN MODE] → [MODE] → [HIGH].)
- Do not move the projector by holding the cable cover. Doing so may result in the projector falling or causing injury.
- Do not unplug the power cable from the wall outlet or projector when the projector is powered on. Doing so can cause damage to the AC IN terminal of the projector and (or) the prong plug of the power cable.  
To turn off the AC power supply when the projector is powered on, use a power strip equipped with a switch and a breaker.
- Do not turn off the AC power for 60 seconds after the lamp is turned on and while the POWER indicator is blinking blue. Doing so could cause premature lamp failure.
- The power plug may be unplugged from the socket after turning off the power supply of the projector.  
Immediately after turning off the AC power supply during video projection, or after turning off the power supply of the projector, the projector cabinet may become very hot momentarily. Please handle with care.

### Caution on Handling the Optional Lens

When shipping the projector with the lens, remove the lens before shipping the projector. Always attach the dust cap to the lens whenever it is not mounted on the projector. The lens and the lens shift mechanism may encounter damage caused by improper handling during transportation.

Do not hold the lens part when carrying the projector.

Doing so could cause the focus ring to rotate, resulting in accidental dropping of the projector.

### Remote Control Precautions

- Handle the remote control carefully.
- If the remote control gets wet, wipe it dry immediately.
- Avoid excessive heat and humidity.
- Do not short, heat, or take apart batteries.
- Do not throw batteries into fire.
- If you will not be using the remote control for a long time, remove the batteries.
- Ensure that you have the batteries' polarity (+/-) aligned correctly.
- Do not use new and old batteries together, or use different types of batteries together.
- Dispose of used batteries according to your local regulations.

### Note for US Residents

The lamp in this product contains mercury. Please dispose according to Local, State or Federal Laws.

### Lamp Replacement

- Use the specified lamp for safety and performance.
- To replace the lamp, follow all instructions provided on page 178.
- Be sure to replace the lamp and filter when the message **[THE LAMP HAS REACHED THE END OF ITS USABLE LIFE. PLEASE REPLACE THE LAMP AND FILTER. USE THE SPECIFIED LAMP FOR SAFETY AND PERFORMANCE.]** appears. If you continue to use the lamp after the lamp has reached the end of its usable life, the lamp bulb may shatter, and pieces of glass may be scattered in the lamp case. Do not touch them as the pieces of glass may cause injury.

If this happens, contact your dealer for lamp replacement.

### A Lamp Characteristic

The projector has a discharge lamp for special purposes as a light source.

A lamp has a characteristic that its brightness gradually decreases with age. Also repeatedly turning the lamp on and off will increase the possibility of its lower brightness.

### CAUTION:

- DO NOT TOUCH THE LAMP immediately after it has been used. It will be extremely hot. Turn the projector off and then disconnect the power cord. Allow at least one hour for the lamp to cool before handling.
- When removing the lamp from a ceiling-mounted projector, make sure that no one is under the projector. Glass fragments could fall if the lamp has been burned out.

### About High Altitude mode

- Set [FAN MODE] to [HIGH ALTITUDE] when using the projector at altitudes approximately 5500 feet/1700 meters or higher.  
Using the projector at altitudes approximately 5500 feet/1700 meters or higher without setting to [HIGH ALTITUDE] can cause the projector to overheat and the protector could shut down. If this happens, wait a couple minutes and turn on the projector.
- Using the projector at altitudes less than approximately 5500 feet/1700 meters and setting to [HIGH ALTITUDE] can cause the lamp to overcool, causing the image to flicker. Switch [FAN MODE] to [AUTO].
- Using the projector at altitudes approximately 5500 feet/1700 meters or higher can shorten the life of optical components such as the lamp.

### About Copyright of original projected pictures:

Please note that using this projector for the purpose of commercial gain or the attraction of public attention in a venue such as a coffee shop or hotel and employing compression or expansion of the screen image with the following functions may raise concern about the infringement of copyrights which are protected by copyright law. [ASPECT RATIO], [KEYSTONE], Magnifying feature and other similar features.

### Turkish RoHS information relevant for Turkish market

EEE Yönetmeliğine Uygundur.

This device is not intended for use in the direct field of view at visual display workplaces. To avoid incommoding reflections at visual display workplaces this device must not be placed in the direct field of view.

### Health precautions to users viewing 3D images

Before viewing, be sure to read health care precautions that may be found in the user's manual included with your 3D eyeglasses or your 3D compatible content such as Blu-ray Discs, video games, computer's video files and the like.

To avoid any adverse symptoms, heed the following:

- Do not use 3D eyeglasses for viewing any material other than 3D images.
- Allow a distance of 2 m/7 feet or greater between the screen and a user. Viewing 3D images from too close a distance can strain your eyes.
- Avoid viewing 3D images for a prolonged period of time. Take a break of 15 minutes or longer after every hour of viewing.
- If you or any member of your family has a history of light-sensitive seizures, consult a doctor before viewing 3D images.
- While viewing 3D images, if you get sick such as nausea, dizziness, queasiness, headache, eyestrain, blurry vision, convulsions, and numbness, stop viewing them. If symptoms still persist, consult a doctor.
- View 3D images from the front of the screen. Viewing from an angle may cause fatigue or eyestrain.

### Power management function

In order to keep power consumption low, the following power management functions (1) and (2) have been set when shipped from the factory. Please display the on-screen menu and change the settings (1) and (2) according to the aim of using the projector.

#### 1. **STANDBY MODE (Factory preset: NORMAL)**

- When [NORMAL] is selected for [STANDBY MODE], the following connectors and functions will not work:  
HDMI OUT connector, AUDIO OUT connector, Ethernet/HDBase T Port\*, USB-A Port, LAN functions, Mail Alert function

(→ page 129)

\* MM models serve as Ethernet ports.

#### 2. **AUTO POWER OFF (Factory preset: 60 minutes)**

- When [1:00] is selected for [AUTO POWER OFF], you can enable the projector to automatically turn off in 1 hour if there is no signal received by any input or if no operation is performed.

(→ page 130)



**Clearance for Installing the Projector**

Allow ample clearance between the projector and its surroundings as shown below. The high temperature exhaust coming out of the device may be sucked into the device again. Avoid installing the projector in a place where air movement from the HVAC is directed at the projector. Heated air from the HVAC can be taken in by the projector's intake vent. If this happens, the temperature inside the projector will rise too high causing the over-temperature protector to automatically turn off the projectors power.

**Example 1 – If there are walls on both sides of the projector.**

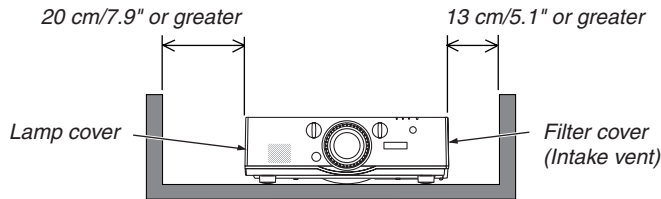

**NOTE:**  
The drawing shows the proper clearance required for the front, back and top of the projector.

**Example 2 – If there is a wall behind the projector.**

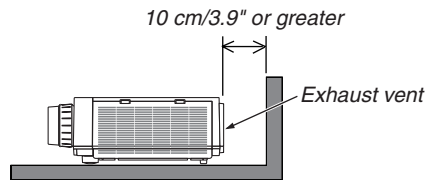

**NOTE:**  
The drawing shows the proper clearance required for the back, sides and top of the projector.

**Example 3 – In the case of portrait projection.**

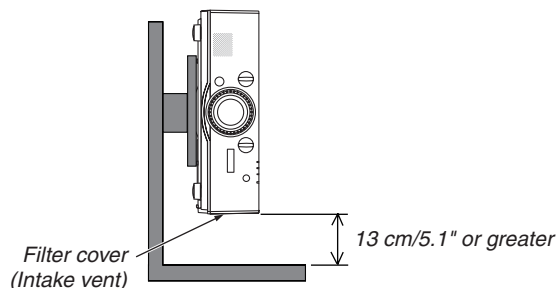

**NOTE:**

- The drawing shows the proper clearance required for the front, back and top of the projector.
- See page 166 for an installation example on portrait projection.

# Table of Contents

---

<b>Important Information</b> .....	i
<b>1. Introduction</b> .....	1
<b>①</b> What's in the Box? .....	1
<b>②</b> Introduction to the Projector .....	2
Congratulations on Your Purchase of the Projector .....	2
Installation.....	2
Videos.....	2
Network.....	3
Energy-saving .....	4
Maintenance .....	4
About this user's manual.....	5
About the Projector's [NETWORK SETTINGS] .....	6
<b>③</b> Part Names of the Projector .....	7
Front/Top.....	7
Rear .....	8
Controls/Indicator Panel.....	9
Terminals .....	10
<b>④</b> Part Names of the Remote Control .....	11
Battery Installation .....	12
Remote Control Precautions.....	12
Operating Range for Wireless Remote Control.....	13
<b>2. Projecting an Image (Basic Operation)</b> .....	14
<b>①</b> Flow of Projecting an Image.....	14
<b>②</b> Connecting Your Computer/Connecting the Power Cord.....	15
<b>③</b> Turning on the Projector .....	16
Note on Startup screen (Menu Language Select screen).....	17
<b>④</b> Selecting a Source .....	18
Selecting the computer or video source.....	18
<b>⑤</b> Adjusting the Picture Size and Position .....	20
Adjusting the vertical position of a projected image (Lens shift).....	21
Focus .....	22
Applicable lens: NP30ZL.....	23
Applicable lens: NP11FL.....	24
Zoom.....	25
Adjusting the Tilt Feet .....	25
<b>⑥</b> Optimizing Computer Signal Automatically .....	26
Adjusting the Image Using Auto Adjust.....	26
<b>⑦</b> Turning Up or Down Volume .....	26
<b>⑧</b> Turning off the Projector .....	27
<b>⑨</b> After Use.....	28
<b>3. Convenient Features</b> .....	29
<b>①</b> Turning off the Image and Sound .....	29
<b>②</b> Freezing a Picture .....	30
<b>③</b> Enlarging a Picture .....	30

④ Changing Eco Mode/Checking Energy-Saving Effect Using Eco Mode [ECO MODE] .....	31
Checking Energy-Saving Effect [CARBON METER] .....	32
⑤ Using the Optional Remote Mouse Receiver (NP01MR) .....	33
⑥ Correcting Horizontal and Vertical Keystone Distortion [CORNERSTONE] .....	35
⑦ Preventing the Unauthorized Use of the Projector [SECURITY] .....	38
⑧ Projecting 3D videos.....	41
Procedure to watch 3D videos using this projector.....	41
When videos cannot be viewed in 3D .....	43
⑨ Controlling the Projector by Using an HTTP Browser .....	44
⑩ Projecting Your Computer's Screen Image from the Projector via a Network [NETWORK PROJECTOR] (MM Models).....	54
⑪ Using the Projector to Operate Your Computer via a Network [REMOTE DESKTOP] (MM Models).....	58
Prepare a commercially available wireless keyboard (US layout version). .....	58
Setting the password to the user account of Windows 7 .....	59
Setting the Remote Access.....	59
Checking the IP address on Windows 7 .....	59
Starting the Remote Desktop.....	60
<b>4. Multi-Screen Projection .....</b>	<b>63</b>
① Things that can be done using multi-screen projection .....	63
Case 1. Using a single projector to project two types of videos [PIP/PICTURE BY PICTURE] .....	63
Case 2. Using four projectors (liquid crystal panel: XGA) to project videos with a resolution of 1920 × 1080 pixels [TILING].....	64
Things to note when installing projectors.....	66
② Displaying Two Pictures at the Same Time.....	67
Projecting two screens.....	68
Switching the main display with the sub-display and vice versa .....	69
Restrictions .....	70
③ Displaying a Picture Using [EDGE BLENDING].....	71
Setting the overlap of projection screens.....	72
Black Level Adjustment.....	75
<b>5. Using On-Screen Menu.....</b>	<b>77</b>
① Using the Menus.....	77
② Menu Elements.....	78
③ List of Menu Items .....	79
④ Menu Descriptions & Functions [INPUT].....	85
⑤ Menu Descriptions & Functions [ADJUST].....	89
[PICTURE] .....	89
[IMAGE OPTIONS] .....	93
[VIDEO].....	97
[3D SETTINGS] .....	99
⑥ Menu Descriptions & Functions [DISPLAY].....	100
[PIP/PICTURE BY PICTURE].....	100
[GEOMETRIC CORRECTION].....	102

[EDGE BLENDING] .....	106
[MULTI SCREEN].....	107
<b>7</b> Menu Descriptions & Functions [SETUP].....	109
[MENU] .....	109
[INSTALLATION] .....	111
[CONTROL] .....	114
[NETWORK SETTINGS].....	122
[SOURCE OPTIONS] .....	127
[POWER OPTIONS] .....	129
Returning to Factory Default [RESET] .....	131
<b>8</b> Menu Descriptions & Functions [INFO.] .....	133
[USAGE TIME] .....	133
[SOURCE(1)] .....	134
[SOURCE(2)] .....	134
[SOURCE(3)] .....	134
[SOURCE(4)] .....	135
[WIRED LAN].....	135
[VERSION(1)] .....	135
[VERSION(2)] (MM only) .....	135
[OTHERS] .....	136
[CONDITIONS] .....	136
[HDBaseT] .....	137
<b>9</b> Application Menu (MM Models).....	138
IMAGE EXPRESS UTILITY .....	138
DESKTOP CONTROL UTILITY .....	138
NETWORK PROJECTOR.....	139
REMOTE DESKTOP CONNECTION .....	139
NETWORK SETTINGS(MM) .....	140
<b>6. Connecting to Other Equipment</b> .....	155
<b>1</b> Mounting a lens (sold separately).....	155
Mounting the lens.....	155
Removing the lens .....	156
<b>2</b> Making Connections.....	157
Analog RGB signal connection .....	157
Digital RGB signal connection .....	158
Connecting an External Monitor .....	161
Connecting Your Blu-ray Player or Other AV Equipment.....	162
Connecting Component Input .....	163
Connecting HDMI Input.....	164
Connecting to a HDBaseT transmission device (sold commercially) (HDBaseT Models) .....	165
Portrait projection (vertical orientation) .....	166
Connecting to a Wired LAN .....	169
Connecting to a Wireless LAN (sold separately) (MM Models).....	170
Mounting a wireless LAN unit .....	170
To remove the wireless LAN unit.....	172
Example of wireless LAN connection.....	173
<b>7. Maintenance</b> .....	174

①	Cleaning the Filters.....	174
②	Cleaning the Lens.....	177
③	Cleaning the Cabinet.....	177
④	Replacing the Lamp and the Filters.....	178
<b>8.</b>	<b>User Supportware.....</b>	<b>183</b>
①	Operating Environment for Software Included on CD-ROM.....	183
	Names and Features of Bundled Software Programs.....	183
	Download service.....	184
	Operating Environment.....	184
②	Installing Software Program.....	186
	Installation for Windows software.....	186
	Using on Mac OS.....	188
③	Operating the Projector Via the LAN (Virtual Remote Tool).....	189
	Connect the projector to a LAN.....	190
④	Controlling the Projector over a LAN (PC Control Utility Pro 4/Pro 5).....	192
⑤	Projecting Your Computer's Screen Image or Video from the Projector over a LAN (Image Express Utility Lite) (MM Models).....	196
	Starting Image Express Utility Lite from a USB Memory or SD Card.....	201
⑥	Projecting an Image from an Angle (Geometric Correction Tool in Image Express Utility Lite) (MM Models).....	203
	What you can do with GCT.....	203
	Projecting an Image from an Angle (GCT).....	203
⑦	Projecting Images from the Projector over a LAN (Image Express Utility 2.0) (MM Models).....	205
	What you can do with Image Express Utility 2.0.....	205
	Connecting the projector to a LAN.....	206
	Basic Operation of Image Express Utility 2.0.....	207
⑧	Using the Projector to Operate Your Computer over a LAN (Desktop Control Utility 1.0) (MM Models).....	216
	What you can do with Desktop Control Utility 1.0.....	216
	Connecting the projector to a LAN.....	216
	Using the projector to operate your computer's desktop screen.....	217
<b>9.</b>	<b>Using the Viewer (MM Models).....</b>	<b>225</b>
①	What you can do with the Viewer.....	225
②	Preparing presentation materials.....	228
③	Projecting images stored in a USB memory device.....	229
	Starting the Viewer.....	229
	Exiting the Viewer.....	234
	Names and functions of Viewer screen.....	235
	Viewer option settings.....	240
④	Projecting data from shared folder.....	243
	Connecting the projector to the shared folder.....	243
	Disconnecting the shared folder from the projector.....	246
⑤	Projecting data from media server.....	247
	Setting up "Media Sharing" in Windows Media Player 11.....	247
	Setting up "Media Sharing" in Windows Media Player 12.....	249

Connecting the projector to the media server .....	250
Disconnecting the projector from the media server .....	251
⑥ Restrictions on displaying files .....	252
Some restrictions on PowerPoint files .....	252
Some restrictions on Excel files .....	252
Some restrictions on PDF files .....	252
<b>10. Appendix</b> .....	<b>253</b>
① Throw distance and screen size .....	253
Lens types and throw distance .....	253
Tables of screen sizes and dimensions .....	256
Lens shifting range.....	257
② Compatible Input Signal List.....	259
③ Specifications .....	262
[HDBaseT Models].....	262
[MM Models] .....	264
④ Cabinet Dimensions .....	266
⑤ Mounting the cable cover (sold separately) .....	267
⑥ Pin assignments and signal names of main connectors.....	268
⑦ Troubleshooting .....	270
Indicator Messages.....	270
Common Problems & Solutions .....	272
If there is no picture, or the picture is not displayed correctly.....	274
⑧ PC Control Codes and Cable Connection .....	275
⑨ Troubleshooting Check List.....	276
⑩ REGISTER YOUR PROJECTOR! (for residents in the United States, Canada, and Mexico) .....	278

# 1. Introduction

## ① What's in the Box?

Make sure your box contains everything listed. If any pieces are missing, contact your dealer. Please save the original box and packing materials if you ever need to ship your projector.

Projector

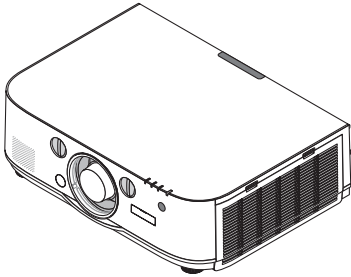

Dust cap for lens

\* The projector is shipped without a lens. For the types of lens and throw distances, see page 253.

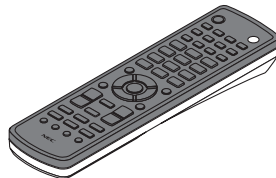

Remote control  
(7N901081)

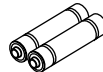

AA alkaline batteries  
(x2)

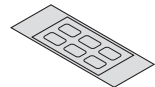

Input selection character sticker

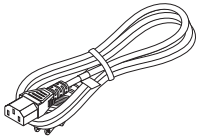

Power cord  
(US: 7N080241)



Lens theft prevention screw  
(24V00841)  
This screw makes it difficult to remove the lens mounted on the projector. (→ page 156)

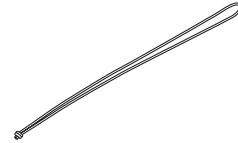

Straps (24J23901) (for preventing lamp cover from falling)  
Attaching the straps to the lamp cover prevents them from falling when the projector is suspended from the ceiling.

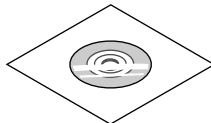
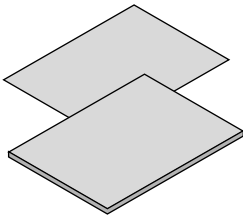

## ② Introduction to the Projector

This section introduces you to your new projector and describes the features and controls.

### Congratulations on Your Purchase of the Projector

This projector is one of the very best projectors available today. The projector enables you to project precise images up to 500 inches across (measured diagonally) from your PC or Mac computer (desktop or notebook), VCR, Blu-ray player, or document camera.

You can use the projector on a tabletop or cart, you can use the projector to project images from behind the screen, and the projector can be permanently mounted on a ceiling\*<sup>1</sup>. The remote control can be used wirelessly.

\*<sup>1</sup> Do not attempt to mount the projector on a ceiling yourself.

The projector must be installed by qualified technicians in order to ensure proper operation and reduce the risk of bodily injury.

In addition, the ceiling must be strong enough to support the projector and the installation must be in accordance with any local building codes. Please consult your dealer for more information.

### Installation

- **Liquid crystal type high brightness/high resolution projector**

Model	Brightness	Resolution	Aspect Ratio
6762WUA/6762WU	6200 lm	WUXGA (1920 × 1200)	16:10
6752WUA/6752WU	5200 lm	WUXGA (1920 × 1200)	16:10
6767WA/6767W	6700 lm	WXGA (1280 × 800)	16:10
6757WA/6757W	5700 lm	WXGA (1280 × 800)	16:10
6772A/6772	7200 lm	XGA (1024 × 768)	4:3
6762A/6762	6200 lm	XGA (1024 × 768)	4:3

- **Wide range of optional lenses selectable according to the place of installation**

This projector supports 6 types of optional lenses, providing a selection of lenses adapted to a variety of places of installation and projection methods.

In addition, the lenses can be mounted and removed in one touch.

Note that no lens is mounted upon shipment from the factory. Please purchase optional lenses separately.

- **Lens shift function for easily adjusting the position of the projected image**

The position of the projected image is moved by turning the two dials on the projector's front, one for the vertical direction, one for the horizontal direction.

- **360° installation angle (tilt-free)**

The projector can be installed at any angle (360°).

Note, however, that the "fan mode" setting must be changed according to the angle of installation.

Also, the projector cannot be installed tilted to the left or right.

- **Portrait projection is possible**

This projector can perform portrait projection with the projection screen turned 90°.

However, the lamp replacement time\* is 2000 hours for portrait projection.

\* Replacement time not guaranteed.

### Videos

- **Wide range of input/output connectors (HDMI, DisplayPort, BNC, etc.) and built-in monaural speaker**

The projector is equipped with a variety of input/output connectors: HDMI (input × 2, output × 1), DisplayPort, BNC (5-core), computer (analog), etc.

The projector's HDMI input/output connectors and DisplayPort input connector support HDCP.

The projector is also equipped with a built-in 10W monaural speaker.



- **Equipped with HDBaseT input terminal [HDBaseT Models]**

This projector is equipped with a HDBaseT input terminal which can be connected to a HDBaseT transmission device sold commercially.

HDBaseT is a connection standard for home appliances that is established by the HDBaseT Alliance.

- **Simultaneous display of 2 images (PIP/PICTURE BY PICTURE)**

Two images can be projected simultaneously with a single projector.

There are two types of layouts for the two images: “picture-in-picture” in which a sub-picture is displayed on the main picture, and “picture-by-picture” in which the main and sub pictures are displayed next to each other.

- **Multi-screen projection using multiple projectors**

This projector is equipped with multiple HDMI input & output terminals that can connect multiple projectors in a daisy chain. A high quality picture is achieved by dividing and projecting high resolution videos among the various projectors.

Furthermore, the boundaries of the screens are smoothed using an edge blending function.

\* Both the composite video signal from each input connector as the computer, BNC, and BNC (CV), and the S-video signal from the BNC (Y/C) Input connector are not output from HDMI OUT Connector of this projector.

- **Seamless switch function for smoother screen changes when switching the signal**

When the input connector is switched, the image displayed before switching is held so that that the new image can be switched to without a break due to absence of a signal.

- **Supports HDMI 3D format**

This projector can be used to watch videos in 3D using commercially-available active shutter-type 3D eyewear and 3D emitters that support Xpand 3D.

### Network

- **Supported by wired LAN/wireless LAN [MM Models] (wireless LAN unit sold separately)**

HDBaseT/Ethernet Port \*Video can be transmitted from a computer equipped with a RF-45 port that is connected to a wired LAN to the projector, and the projector can also be controlled from the computer.

In addition, the MM models can also be used over a wireless LAN by using a wireless LAN unit sold separately.

\* MM models serve as Ethernet ports.

- **LAN-compatible Viewer [MM Models]**

The projector’s built-in Viewer allows you to view images or movie files in the shared folder of your PC connected to a wired or wireless LAN.

\* The Viewer supports the Media Sharing function of Windows Media Player 11.

- **CRESTRON ROOMVIEW compatibility**

The projector supports CRESTRON ROOMVIEW, allowing multiple devices connected in the network to be managed and controlled from a computer or controller.

- **Convenient utility software (User Supportware) provided as standard**

[HDBaseT Models]

The three utility software stored in the enclosed Projector CD-ROM (Virtual Remote Tool, PC Control Utility Pro 4 (for Windows ) and PC Control Utility Pro 5 (for Mac OS )) can be used. The following three utility software on the CD-ROM cannot be used.

Image Express Utility Lite (for Windows/Mac OS), Image Express Utility 2.0 (for Windows) and Desktop Control Utility 1.0 (for Windows)

[MM Models]

The six utility software stored in the attached Projector CD-ROM (Virtual Remote Tool, PC Control Utility Pro 4 (for Windows), PC Control Utility Pro 5 (for Mac OS), Image Express Utility Lite (for Windows/Mac OS), Image Express Utility 2.0 (for Windows), Desktop Control Utility 1.0 (for Windows)) may be used. Image Express Utility Lite

(for Windows) may be started up and used from a USB memory or SD card available commercially even without installing on a computer.

Image Express Utility Lite (for Windows/Mac OS), Image Express Utility 2.0 (for Windows) and Desktop Control Utility 1.0 (for Windows)

### Energy-saving

- **Energy-saving design with a standby power consumption of 0.11 watts (100-130 V)/0.16 watts (200-240 V)**

When the on-screen menu's standby mode is set to "NORMAL", the power consumption in the standby mode is 0.11 watts (100-130 V)/0.16 watts (200-240 V).

- **"Eco mode" for low power consumption and "Carbon Meter" display**

The projector is equipped with an "eco mode" for reducing power consumption during use. Furthermore, the power-saving effect when the eco mode is set is converted into the amount of reductions of CO<sub>2</sub> emissions and this is indicated on the confirmation message displayed when the power is turned off and at "Information" on the on-screen menu (CARBON METER).

### Maintenance

- **Maximum lamp replacement time of 4000 hours and no need to clean the filters**

When used in the eco mode, the lamp replacement time\* is extended to a maximum of 4000 hours.

\* This time is not guaranteed.

Furthermore, this projector uses large 2-layer filters. When these filters are replaced with new ones when changing the lamp, there is no need for regular filter cleaning.

\* Actual menus may be different from the menu images in this user's manual.

**About this user's manual**

The fastest way to get started is to take your time and do everything right the first time. Take a few minutes now to review the user's manual. This may save you time later on. At the beginning of each section of the manual you'll find an overview. If the section doesn't apply, you can skip it.

**Notation by Main Functions**

These indicate the descriptions of the model groups according to the main functions.

**[HDBaseT Models]**

Applicable to models 6762WUA/6752WUA/6767WA/6757WA/6772A/6762A.

**[MM Models]**

Applicable to models 6762WU/6752WU/6767W/6757W/6772/6762.

\*The description applies to all models if the model name is not indicated.

**Notation by Resolution**

These indicate the descriptions of the model groups according to the resolution of the liquid crystal panels.

**WUXGA Type**

Applicable to models 6762WUA/6762WU/6752WUA/6752WU.

**WXGA Type**

Applicable to models 6767WA/6767W/6757WA/6757W.

**XGA Type**

Applicable to models 6772A/6772/6762A/6762.

\*The description applies to all models if the type name is not indicated.

<b>Note:</b> The Dukane models described in this document are manufactured by NEC and use the same firmware, software programs, control code, and accessory parts. The equivalent Dukane to NEC models are shown in the following table.			
DUKANE	NEC		
6752WU	PA521U	1920x1200 (WUXGA)	5,200 lumens
6752WUA	PA522U	1920x1200 (WUXGA)	5,200 lumens
6757W	PA571W	1280x800 (WXGA)	5,700 lumens
6757WA	PA572W	1280x800 (WXGA)	5,700 lumens
6762	PA621X	1024x768 (XGA)	6,200 lumens
6762A	PA622X	1024x768 (XGA)	6,200 lumens
6762WU	PA621U	1920x1200 (WUXGA)	6,200 lumens
6762WUA	PA622U	1920x1200 (WUXGA)	6,200 lumens
6767W	PA671W	1280x800 (WXGA)	6,700 lumens
6767WA	PA672W	1280x800 (WXGA)	6,700 lumens
6772	PA721X	1024x768 (XGA)	7,200 lumens
6772A	PA722X	1024x768 (XGA)	7,200 lumens

**About the Projector's [NETWORK SETTINGS]**

"NETWORK SETTINGS" need to be carried out when connecting this projector to a wired or wireless LAN.

**For [HDBaseT Models]**

Please configure the projector using the following "1. NETWORK SETTINGS". "2. NETWORK SETTINGS (MM)" cannot be used.

**For [MM Models]**

The following two types of [NETWORK SETTINGS] 1 and 2 can be used. Use the [NETWORK SETTINGS] 1 and 2 for different purposes depending on the software and function described in the table below.

1. "NETWORK SETTINGS" under [SETUP] in the on-screen menu (→ Page 122)

Or "NETWORK SETTINGS" in the HTTP server (→ Page 48)

2. "NETWORK SETTINGS (MM)" in the application menu (→ Page 140)

Or "NETWORK SETTINGS" in the HTTP server (MM) (→ Page 51)

	1. NETWORK SETTINGS	2. NETWORK SETTINGS (MM)
Wired LAN	OK	OK
Wireless LAN	Not OK	OK*
Main uses	Projector control	Transmission of images
Function	<ul style="list-style-type: none"> <li>• PC control</li> <li>• PJLink</li> <li>• AMX BEACON</li> <li>• CRESTRON</li> <li>• ALERT MAIL</li> <li>• HTTP server (PROJECTOR ADJUSTMENT)</li> <li>• Synchronize with an Internet time server</li> </ul>	<ul style="list-style-type: none"> <li>• Shared folder (viewer)</li> <li>• Media Server (viewer)</li> <li>• Network Projector</li> <li>• Remote Desktop</li> </ul>
User Supportware	<ul style="list-style-type: none"> <li>• PC Control Utility Pro 4</li> <li>• PC Control Utility Pro 5</li> <li>• Virtual Remote Tool</li> </ul>	<ul style="list-style-type: none"> <li>• Image Express Utility Lite</li> <li>• Image Express Utility 2.0</li> <li>• Desktop Control Utility 1.0</li> </ul>

\* A wireless LAN unit sold separately is required to connect the projector to a wireless LAN.

### 3 Part Names of the Projector

#### Front/Top

The lens is sold separately. The description below is for when the NP13ZL lens is mounted.

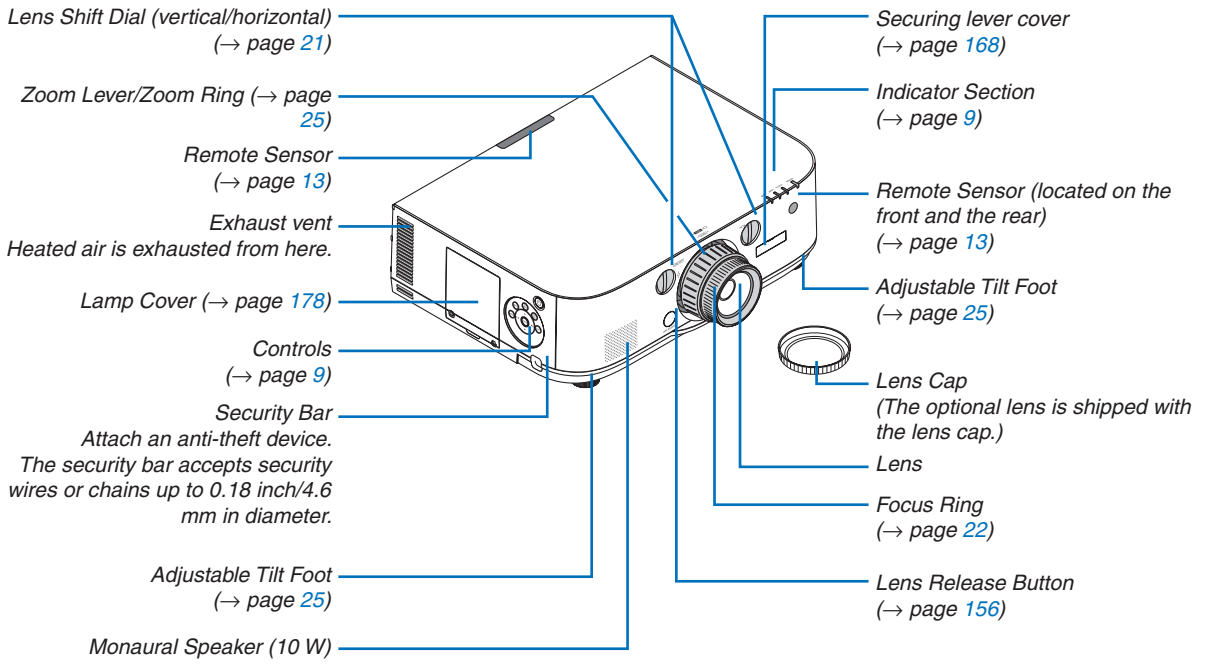

#### Mounting the strap

1. Mount the strap to the filter cover and lamp cover as shown on the diagram below.
2. Insert the knot in the strap into the hole on the bottom of the projector and pull in the direction of the arrow to fasten.

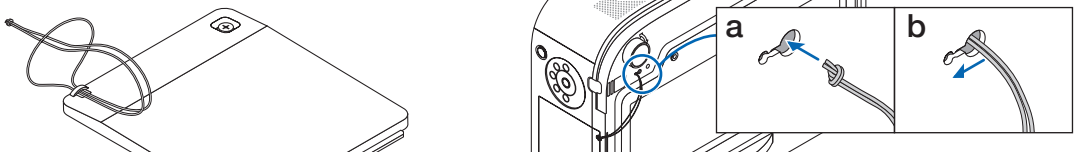

#### How to paste the input selection character sticker of the remote control

- Peel off the cover of the sticker and align the sticker holes with Buttons 1 to 6 before pasting.
  - Please take care not to let the sticker contact the buttons when pasting.
  - The explanations and illustrations in this manual are provided with the sticker pasted.

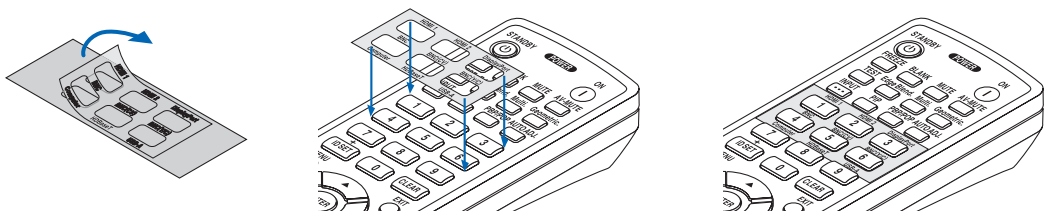



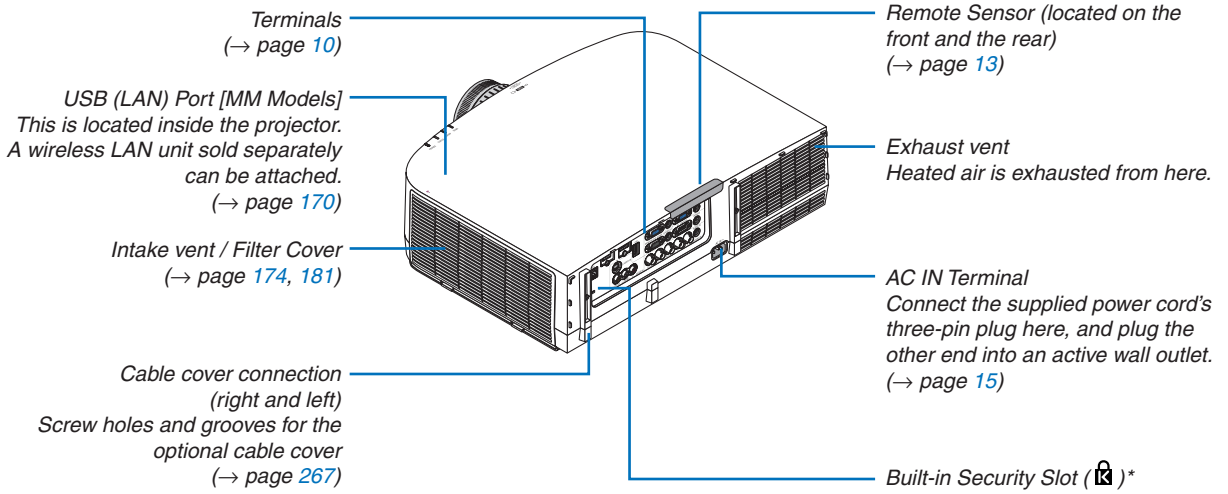

Rear

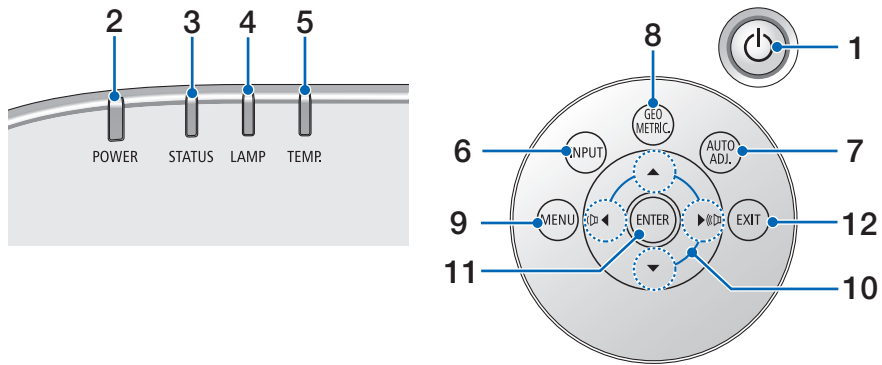

\* This security slot supports the MicroSaver® Security System.

Controls/Indicator Panel



1.  (POWER) Button  
(→ page 16, 27)
2. POWER Indicator  
(→ page 15, 16, 27, 270)
3. STATUS Indicator  
(→ page 270)
4. LAMP Indicator  
(→ page 178, 271)
5. TEMP. Indicator  
(→ page 271)
6. INPUT Button  
(→ page 18)
7. AUTO ADJ. Button  
(→ page 26)
8. Geometric. Button  
(→ page 35)
9. MENU Button  
(→ page 77)
10.  / Volume Buttons   
(→ page 26, 77)
11. ENTER Button  
(→ page 77)
12. EXIT Button  
(→ page 77)

Terminals

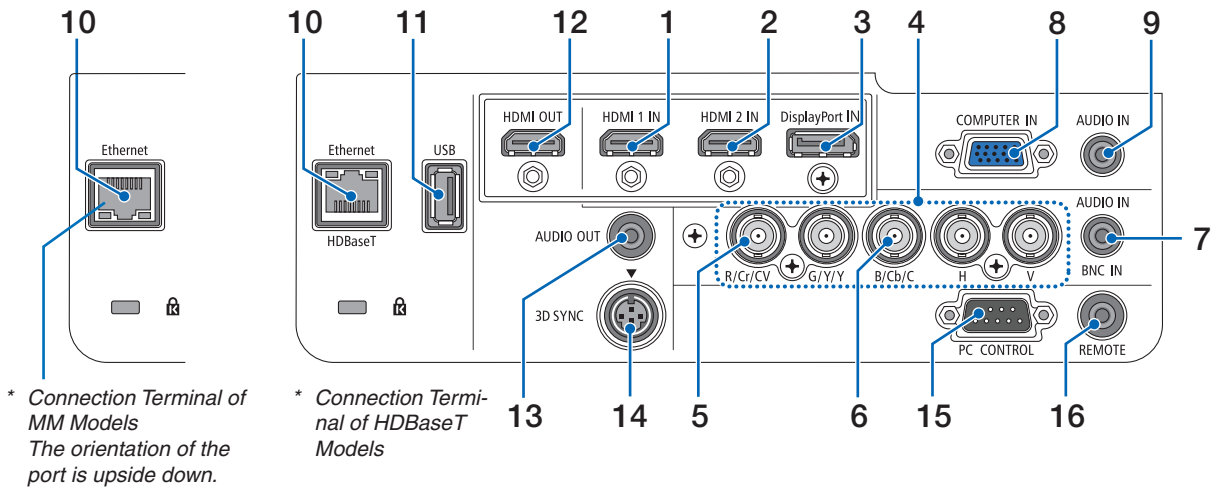

1. **HDMI 1 IN Connector (Type A)**  
(→ page 158, 160, 164)
2. **HDMI 2 IN Connector (Type A)**  
(→ page 158, 160, 164)
3. **DisplayPort IN Connector**  
(→ page 158)
4. **BNC IN [R/Cr/CV, G/Y/Y, B/Cb/C, H, V] Connectors (BNC × 5)**  
(→ page 157, 162)
5. **BNC (CV) Input Connector (BNC × 1)**  
(→ page 162)
6. **BNC (Y/C) Input Connector (BNC × 2)**  
(→ page 162)
7. **BNC AUDIO IN Mini Jack (Stereo Mini)**  
(→ page 160, 162)
8. **COMPUTER IN/ Component Input Connector (Mini D-Sub 15 Pin)**  
(→ page 157, 163)
9. **COMPUTER AUDIO IN Mini Jack (Stereo Mini)**  
(→ page 157, 163)
10. **Ethernet/HDBaseT Port (RJ-45) [HDBaseT Models]**  
(→ page 165, 169)  
**Ethernet Port (RJ-45) [MM Models]**  
(→ page 169)
11. **USB-A Port (Type A)**  
(→ page 225)  
(HDBaseT Models: For future expansion. This port allows for power supply.)
12. **HDMI OUT Connector (Type A)**  
(→ page 161)

13. **AUDIO OUT Mini Jack (Stereo Mini)**  
(→ page 161)
14. **3D SYNC Connector (Mini DIN 4 Pin)**  
(→ page 41)
15. **PC CONTROL Port (D-Sub 9 Pin)**  
(→ page 269)  
Use this port to connect a PC or control system. This enables you to control the projector using serial communication protocol. If you are writing your own program, typical PC control codes are on page 275.
16. **REMOTE Connector (Stereo Mini)**  
Use this connector for wired remote control of the projector using the NEC remote control for PX750U/PH1000U/PH1400U series.  
Connect the projector and optional remote control using a commercially available wired remote control cable.

NOTE:

- When a remote control cable is connected to the REMOTE connector, infrared remote control operations cannot be performed.
- Both the composite video signal from each input connector as the computer, BNC, and BNC (CV), and the S-video signal from the BNC (Y/C) Input connector are not output from HDMI OUT Connector of this projector.

[HDBaseT Models]

- When [HDBaseT] is selected in the [REMOTE SENSOR] and the projector is connected to a commercially-available transmission device that supports HDBaseT, remote control operations in infra-red cannot be carried out if transmission of remote control signals has been set up in the transmission device. However, remote control using infrared rays can be carried out when the power supply of the transmission device is switched off.



## 4 Part Names of the Remote Control

The HDBaseT model is described in the illustrations of the remote control.

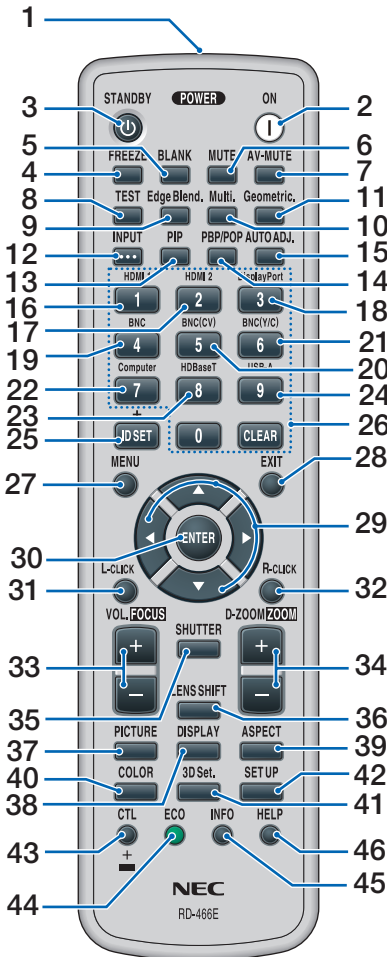

- |    |   |   |   |
|----|---|---|---|
| 1  | <b>1. Infrared Transmitter</b><br>(→ page 13) | 8. <b>TEST Button</b><br>(→ page 85)  | 28. <b>EXIT Button</b><br>(→ page 77)   |
| 2  | <b>2. POWER ON Button</b><br>(→ page 16)      | 9. <b>Edge Blend. Button</b><br>(→ page 71, 106)  | 29. <b>▲▼◀▶ Button</b><br>(→ page 77)   |
| 3  | <b>3. STANDBY Button</b><br>(→ page 27)       | 10. <b>Multi. Button</b><br>(→ page 107)  | 30. <b>ENTER Button</b><br>(→ page 77)  |
| 4  | <b>4. FREEZE Button</b><br>(→ page 30)        | 11. <b>Geometric. Button</b><br>(→ page 35, 102)  | 31. <b>L-CLICK Button*</b><br>(→ page 34)   |
| 5  | <b>5. BLANK Button</b><br>(→ page 29)         | 12. <b>INPUT Button</b><br>(→ page 18)  | 32. <b>R-CLICK Button*</b><br>(→ page 34)   |
| 6  | <b>6. MUTE Button</b><br>(→ page 29)          | 13. <b>PIP Button</b><br>(→ page 68)  | 33. <b>VOL./FOCUS (+)(-) Button</b><br>(→ page 26)  |
| 7  | <b>7. AV-MUTE Button</b><br>(→ page 29)       | 14. <b>PBP/POP Button</b><br>(→ page 68)  | 34. <b>D-ZOOM/ZOOM (+)(-) Button</b><br>(→ page 30)<br>("ZOOM" Button does not work on this series of projectors) |
| 8  |   | 15. <b>AUTO ADJ. Button</b><br>(→ page 26)  | 35. <b>SHUTTER Button</b><br>(not available on this series of projectors)   |
| 9  |   | 16. <b>1 (HDMI 1) Button</b><br>(→ page 18)   | 36. <b>LENS SHIFT Button</b><br>(not available on this series of projectors)                                      |
| 10 |   | 17. <b>2 (HDMI 2) Button</b><br>(→ page 18)   | 37. <b>PICTURE Button</b><br>(→ page 89)  |
| 11 |   | 18. <b>3 (DisplayPort) Button</b><br>(→ page 18)  | 38. <b>DISPLAY Button</b><br>(→ page 100)   |
| 12 |   | 19. <b>4 (BNC) Button</b><br>(→ page 18)  | 39. <b>ASPECT Button</b><br>(→ page 95)   |
| 13 |   | 20. <b>5 (BNC(CV)) Button</b><br>(→ page 18)  | 40. <b>COLOR Button</b><br>(→ page 91)  |
| 14 |   | 21. <b>6 (BNC(Y/C)) Button</b><br>(→ page 18)   | 41. <b>3D Set. Button</b><br>(→ page 99)  |
| 15 |   | 22. <b>7 (Computer) Button</b><br>(→ page 18)   | 42. <b>SETUP Button</b><br>(→ page 109)   |
| 16 |   | 23. <b>8 (HDBaseT) Button [HDBaseT Models]</b><br><b>8 (Ethernet) Button [MM Models]</b><br>(→ page 18) | 43. <b>CTL Button</b><br>(→ page 34)  |
| 17 |   | 24. <b>9 (USB-A) Button</b><br>(→ page 18)  | 44. <b>ECO Button</b><br>(→ page 31)  |
| 18 |   | 25. <b>ID SET Button</b><br>(→ page 120)  | 45. <b>INFO Button</b><br>(→ page 134)  |
| 19 |   | 26. <b>Numeric Keypad Button/ CLEAR Button</b><br>(→ page 120)  | 46. <b>HELP Button</b><br>(→ page 134)  |
| 20 |   | 27. <b>MENU Button</b><br>(→ page 77)   |   |

\* The ▲▼◀▶, L-CLICK and R-CLICK buttons work only when a USB cable is connected with your computer.

### Battery Installation

1. Press the catch and remove the battery cover.
2. Install new ones (AA). Ensure that you have the batteries' polarity (+/-) aligned correctly.
3. Slip the cover back over the batteries until it snaps into place.

*NOTE: Do not mix different types of batteries or new and old batteries.*

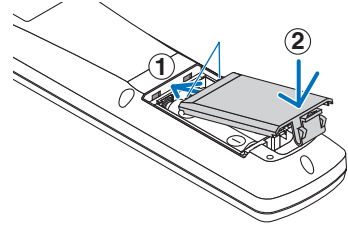
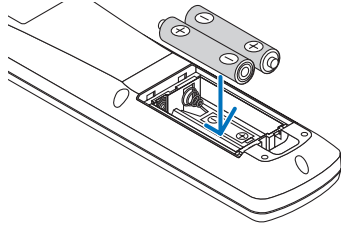
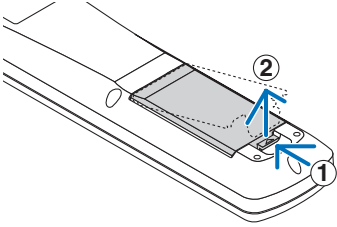

### Remote Control Precautions

- Handle the remote control carefully.
- If the remote control gets wet, wipe it dry immediately.
- Avoid excessive heat and humidity.
- Do not short, heat, or take apart batteries.
- Do not throw batteries into fire.
- If you will not be using the remote control for a long time, remove the batteries.
- Ensure that you have the batteries' polarity (+/-) aligned correctly.
- Do not use new and old batteries together, or use different types of batteries together.
- Dispose of used batteries according to your local regulations.

## Operating Range for Wireless Remote Control

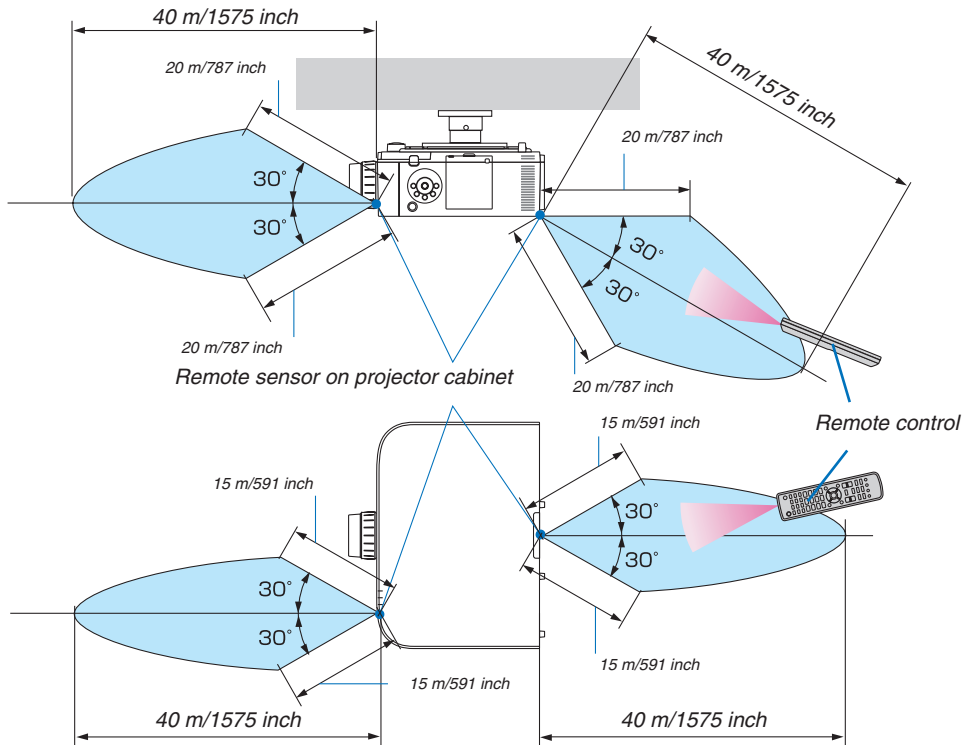

- The infrared signal operates by line-of-sight up to a distance of above meters and within a 60-degree angle of the remote sensor on the projector cabinet.
- The projector will not respond if there are objects between the remote control and the sensor, or if strong light falls on the sensor. Weak batteries will also prevent the remote control from properly operating the projector.

## 2. Projecting an Image (Basic Operation)

---

This section describes how to turn on the projector and to project a picture onto the screen.

### ① Flow of Projecting an Image

#### Step 1

- *Connecting your computer / Connecting the power cord* (→ [page 15](#))



#### Step 2

- *Turning on the projector* (→ [page 16](#))



#### Step 3

- *Selecting a source* (→ [page 18](#))



#### Step 4

- *Adjusting the picture size and position* (→ [page 20](#))
- *Correcting keystone distortion [CORNERSTONE]* (→ [page 35, 102](#))



#### Step 5

- *Adjusting a picture and sound*
  - *Optimizing a computer signal automatically* (→ [page 26](#))
  - *Turning up or down volume* (→ [page 26](#))



#### Step 6

- *Making a presentation*



#### Step 7

- *Turning off the projector* (→ [page 27](#))



#### Step 8

- *After use* (→ [page 28](#))

### ② Connecting Your Computer/Connecting the Power Cord

#### 1. Connect your computer to the projector.

This section will show you a basic connection to a computer. For information about other connections, see “(2) Making Connections” on page 157.

Connect the display output terminal (mini D-sub 15 pin) on the computer to the computer video input terminal on the projector with a commercially-available computer cable (with ferrite core) and then turn the knobs of the connectors to secure them.

#### 2. Connect the supplied power cord to the projector.

First connect the supplied power cord's three-pin plug to the AC IN terminal of the projector, and then connect the other plug of the supplied power cord in the wall outlet.

Upon connecting the power cable, the POWER indicator of the projector will light up in orange. If there are no input signals, the device will go into the standby mode after about 10 seconds and light up in red\*.

The STATUS indicator will light off\*.

\* This will apply for both indicators when [NORMAL] is selected for [STANDBY MODE]. See the Power Indicator section. (→ page 270)

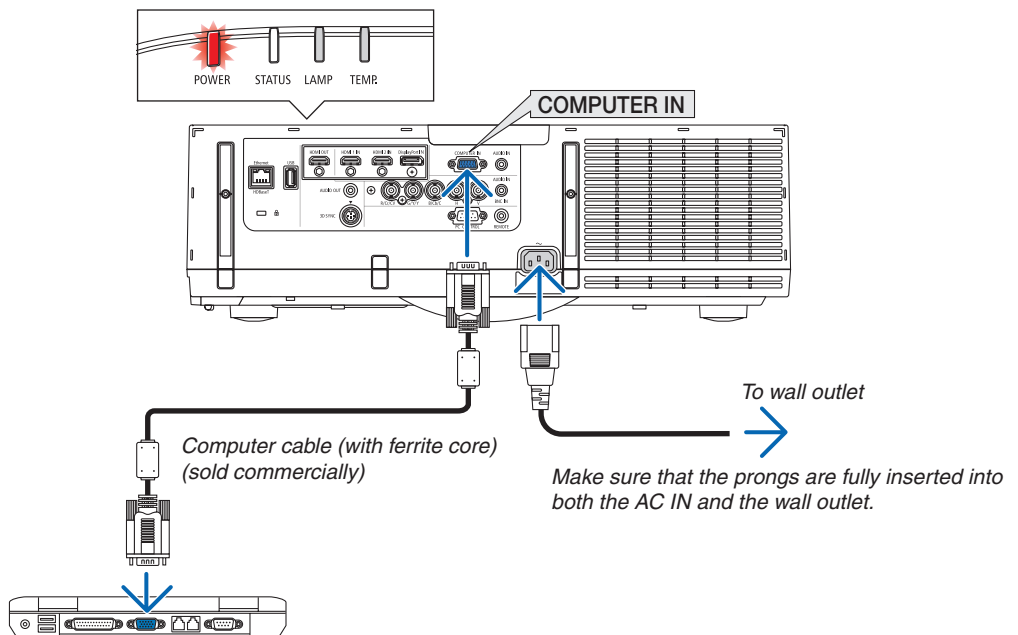

#### **⚠ CAUTION:**

Parts of the projector may become temporarily heated if the projector is turned off with the POWER button or if the AC power supply is disconnected during normal projector operation.

Use caution when picking up the projector.

### 3 Turning on the Projector

#### 1. Remove the lens cap.

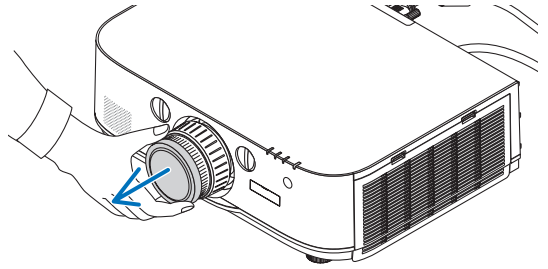

#### 2. Press the (POWER) button on the projector cabinet or the POWER ON button on the remote control.

The POWER indicator will light up in blue from red and then start blinking. After that, the image will be projected onto the screen.

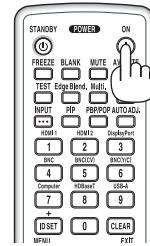

#### TIP:

- When the message “PROJECTOR IS LOCKED! ENTER YOUR PASSWORD.” is displayed, it means that the [SECURITY] feature is turned on. (→ page 38)
- When the ECO message is displayed, it means that [ON] is selected for [ECO MESSAGE]. (→ page 110)
- Pressing buttons such as power button and MENU button will make sound. To turn off the beep sound, select [OFF] for [BEEP] from the menu. (→ page 121)

After you turn on your projector, ensure that the computer or video source is turned on.

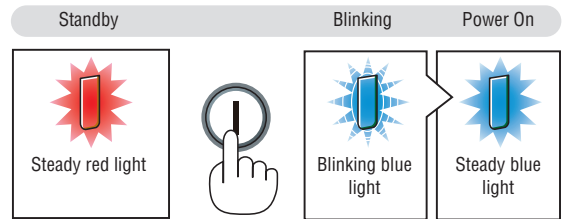

(→ page 270)

**NOTE:** A blue screen (blue background) is displayed when no signal is being input (by factory default menu settings).

## 2. Projecting an Image (Basic Operation)

### Note on Startup screen (Menu Language Select screen)

When you first turn on the projector, you will get the Startup menu. This menu gives you the opportunity to select one of the 29 menu languages.

To select a menu language, follow these steps:

1. Use the ▲, ▼, ◀ or ▶ button to select one of the 29 languages from the menu.

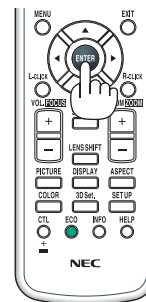
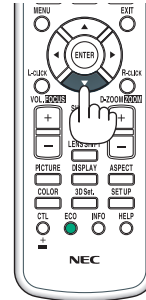

2. Press the **ENTER** button to execute the selection.

After this has been done, you can proceed to the menu operation.

If you want, you can select the menu language later.

(→ [LANGUAGE] on page 81 and 109)

### NOTE:

- During projection, after shutting down the power supply (direct power off), wait for about 1 minute or longer before turning on the power again.
- Keep the lens cap off the lens while the projector's power is on. If the lens cap is on, it could be warped due to high temperature.
- If one of the following things happens, the projector will not turn on.
  - If the internal temperature of the projector is too high, the projector detects abnormal high temperature. In this condition the projector will not turn on to protect the internal system. If this happens, wait for the projector's internal components to cool down.
  - When the lamp reaches its end of usable life, the projector will not turn on. If this happens, replace the lamp.
  - If the STATUS indicator lights orange with the power button pressed, it means that the [CONTROL PANEL LOCK] is turned on. Cancel the lock by turning it off. (→ page 119)
  - If the lamp fails to light, and if the LAMP indicator flashes on and off in a cycle of six times, wait a full minute and then turn on the power.
- While the POWER indicator is blinking blue in short cycles, the power cannot be turned off by using the power button.
- Immediately after turning on the projector, screen flicker may occur. This is normal. Wait 3 to 5 minutes until the lamp lighting is stabilized.
- When the projector is turned on, it may take some time before the lamp light becomes bright.
- If you turn on the projector immediately after the lamp is turned off or when the temperature is high, the fans run without displaying an image for some time and then the projector will display the image.

### 4 Selecting a Source

#### Selecting the computer or video source

*NOTE: Turn on the computer or video source equipment connected to the projector.*

#### Detecting the Signal Automatically

Press the INPUT button for 1 second or longer. The projector will search for the available input source and display it. The input source will change as follows:

[HDBaseT Models]

HDMI1 → HDMI2 → DisplayPort → BNC → BNC(CV) → BNC(Y/C) → COMPUTER → HDBaseT → HDMI1 → ...

[MM Models]

Automatically checks for any input signal in the order HDMI 1 → HDMI 2 → Display Port → BNC → BNC(CV) → BNC(Y/C) → COMPUTER → USB-A. The input signal will be projected when it is detected.

- Press it briefly to display the [INPUT] screen.

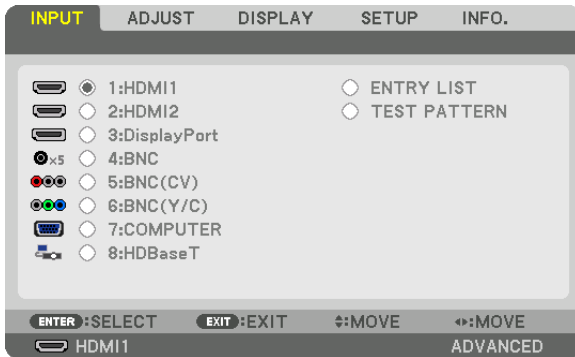
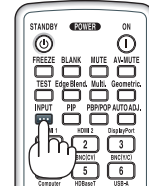

- \* This screen belongs to a HDBaseT model.

Press the ▼/▲ buttons to match the target input terminal and then press the ENTER button to switch the input. To delete the menu display in the [INPUT] screen, press the MENU or EXIT button.

*TIP: If no input signal is present, the input will be skipped.*

#### Using the Remote Control

Press any one of the 1/HDMI 1, 2/HDMI 2, 3/DisplayPort, 4/BNC, 5/BNC(CV), 6/BNC(Y/C), 7/Computer, 8/HDBaseT\*<sup>1</sup>, or 9/USB-A\*<sup>2</sup> buttons.

\*<sup>1</sup> For MM models, "8/Ethernet" will be selected and the projector will switch to the Ethernet.

\*<sup>2</sup> HDBaseT model cannot be used.

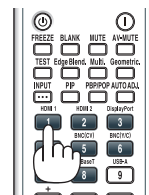



### Selecting Default Source

You can set a source as the default source so that it will be displayed each time the projector is turned on.

**1. Press the MENU button.**

The menu will be displayed.

**2. Press the ► button to select [SETUP] and press the ▼ button or the ENTER button to select [BASIC].**

**3. Press the ► button to select [SOURCE OPTIONS].**

**4. Press the ▼ button four times to select [DEFAULT INPUT SELECT] and press the ENTER button.**

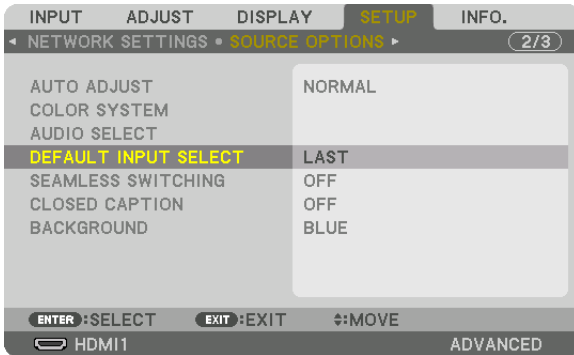

The [DEFAULT INPUT SELECT] screen will be displayed.

(→ page 128)

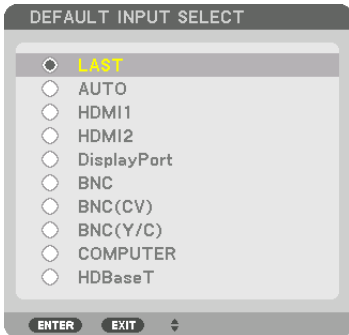

\* This screen belongs to a HDBaseT model.

NOTE:

[MM Models]

- Ethernet cannot be detected automatically even if [DEFAULT INPUT SELECT] has been set to [AUTO]. Select [ETHERNET] in [DEFAULT INPUT SELECT] to enable Ethernet to be selected automatically when power to the projector is turned on.

**5. Select a source as the default source, and press the ENTER button.**

**6. Press the EXIT button a few times to close the menu.**

**7. Restart the projector.**

The source you selected in step 5 will be projected.

NOTE: Even when [AUTO] is turned on, the [HDBaseT] will not be automatically selected. To set your network as the default source, select [HDBaseT].

TIP:

- When the projector is in Standby mode, applying a computer signal from a computer connected to the COMPUTER IN input will power on the projector and simultaneously project the computer's image.  
([AUTO POWER ON SELECT] → page 130)
- On the Windows 7 keyboard, a combination of the Windows and P keys allows you to set up external display easily and quickly.

### 5 Adjusting the Picture Size and Position

Use the lens shift dial, the adjustable tilt foot lever, the zoom lever/zoom ring and the focus ring to adjust the picture size and position.

*In this chapter drawings and cables are omitted for clarity.*

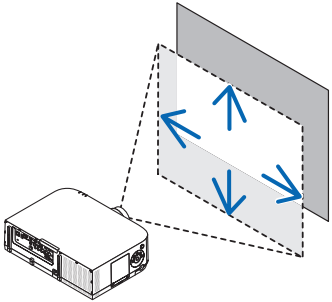
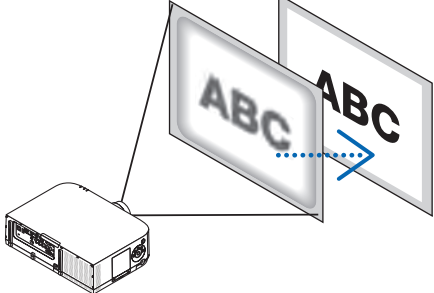
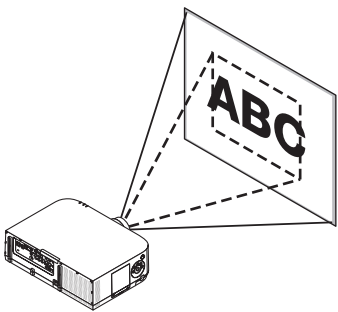
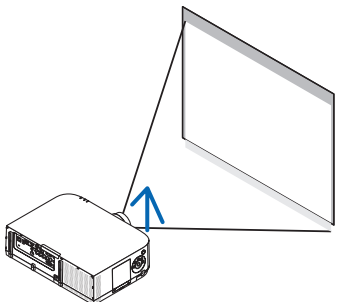
<p>Adjusting the projected image's vertical and horizontal position [Lens shift] (→ page 21)</p> 	<p>Adjusting the focus [Focus ring] (→ page 22)</p> 
<p>Finely adjusting the size of an image [Zoom lever/Zoom ring] (→ page 25)</p> 	<p>Adjusting the projected image's height and horizontal tilt [Tilt foot] *1 (→ page 25)</p> 

**NOTE\*1:** Adjust the projected image's height using the tilt feet when you want to project the image at a position higher than the lens shift adjustment range.

### Adjusting the vertical position of a projected image (Lens shift)

#### CAUTION

Perform the adjustment from behind or from the side of the projector. Adjusting from the front could expose your eyes to strong light which could injure them.

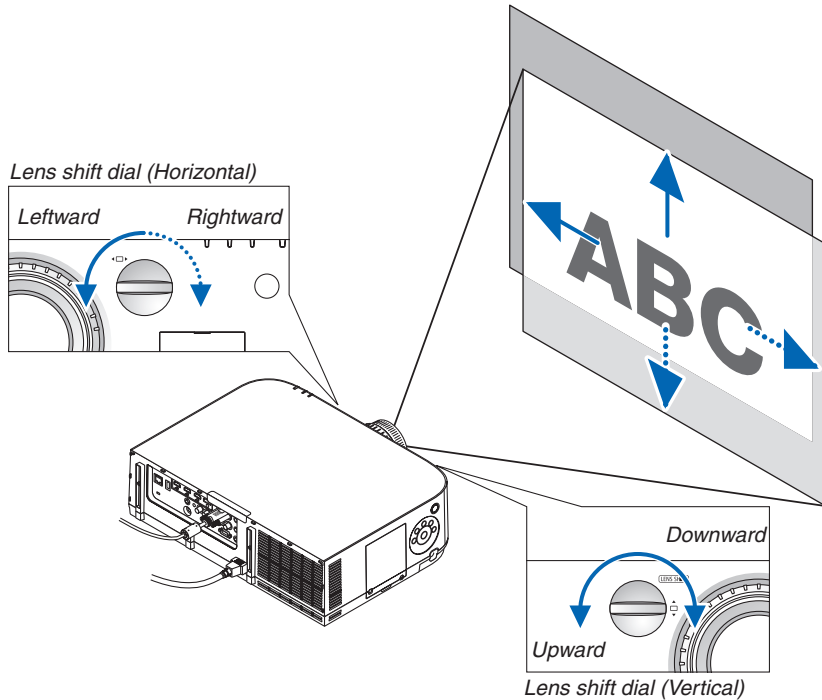

- **Turn the lens shift dials clockwise or counterclockwise.**

#### Vertical dial

Turn this clockwise or counterclockwise to adjust the projection position in the vertical direction.

Approximate turning range: About 6 turns counterclockwise, about 2 turns clockwise when the lens is at the center position.

#### Horizontal dial

Turn this clockwise or counterclockwise to adjust the projection position in the horizontal direction.

Approximate turning range: About 1 turn counterclockwise, about 1 turn clockwise when the lens is at the center position.

#### NOTE:

- The dials can be turned more than one full turn, but the projection position cannot be moved more than the range indicated on the following page.
- If the lens is shifted to the maximum in the diagonal direction, the edges of the screen will be dark or shaded.
- The vertical shift adjustment must be finished with an image shifted upward. If you finish the vertical shift adjustment with an image shifted down, the zoom/focus adjustments or strong shaking may cause a projected image to slightly shift down.
- The lens shift function cannot be used when using the separately sold NP11FL lens.

## 2. Projecting an Image (Basic Operation)

### TIP:

- The diagram below shows the lens shift adjustment range (projection format: desk/front) of the WUXGA type (excluding the lens unit NP30ZL). Use the tilt foot if you wish to raise the projection position beyond this. (→ page 25)
- Refer to Page 257 for the lens shift adjustment range of the WXGA type/XGA type and for ceiling hanging/front projection.

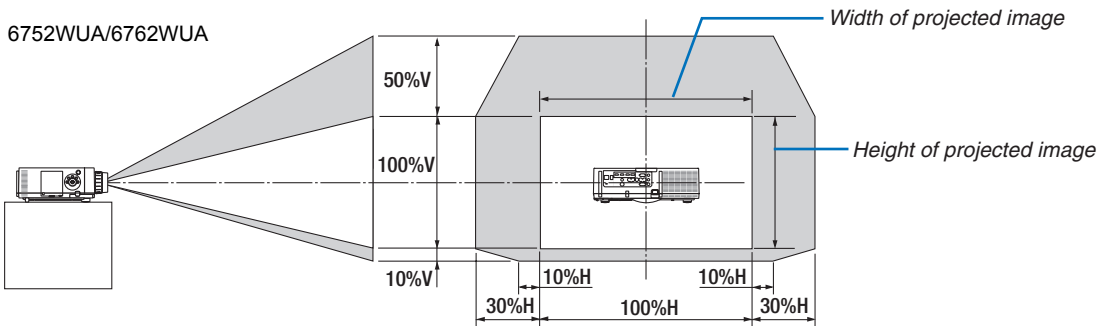

Description of symbols: V indicates vertical (height of the projected image), H indicates horizontal (width of the projected image).

### Focus

Applicable lens: NP12ZL/NP13ZL/NP14ZL/NP15ZL

Use the FOCUS ring to obtain the best focus.

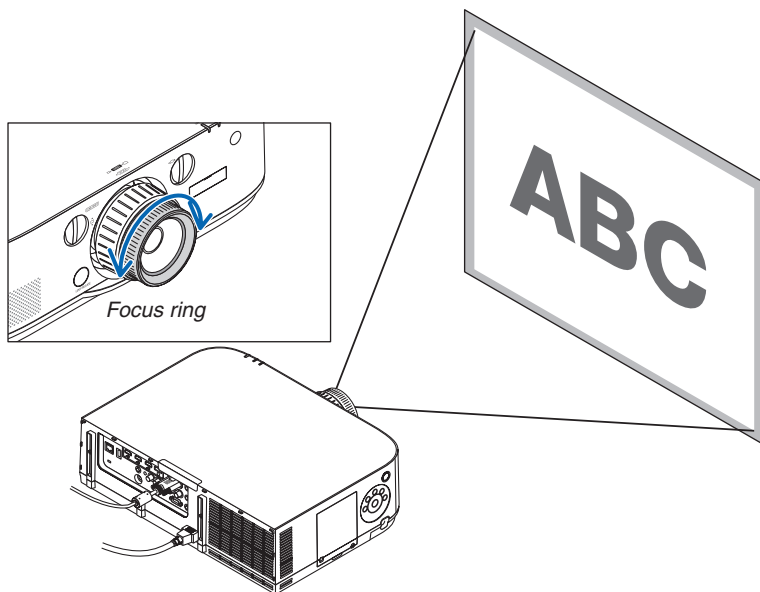

## 2. Projecting an Image (Basic Operation)

### Applicable lens: NP30ZL

The NP30ZL lens unit aligns the peripheral focus around the optical axis.

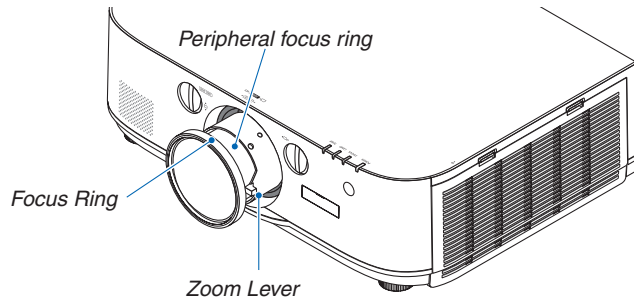

#### 1. Turn the focus ring left and right to align the focus around the optical axis.

\* The diagram shows an example when the lens shift is moved to the top. The top of the screen is adjusted.

When the lens is in the center, the center of the screen is adjusted.

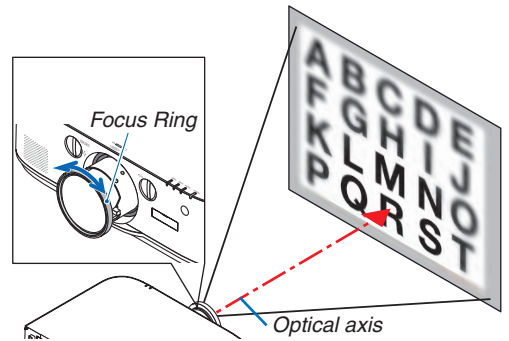

#### 2. Turn the peripheral focus ring to the left and right to align the focus of the overall screen.

At this point, the focus around the optical axis adjusted in (1) remains unchanged.

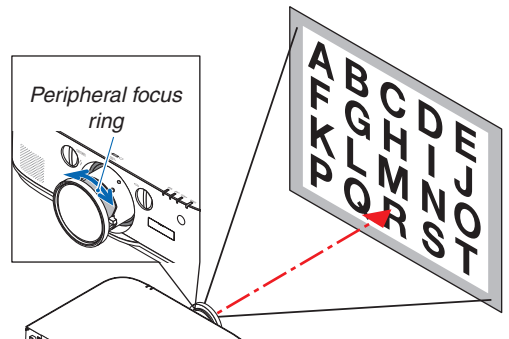

## 2. Projecting an Image (Basic Operation)

### Applicable lens: NP11FL

With the NP11FL lens, adjust the focus and picture distortion.

#### Preparations:

Turn the lens shift dials (vertical and horizontal) on the projector to return the lens shift to the center.

#### Approximate lens center position (explained here for the desktop front projection mode)

Horizontal dial..... First turn the dial to the left edge, then turn it further so that the knob is horizontal. From this position, turn the dial 1 full turn clockwise.

Vertical dial..... First turn the dial to the bottom edge, then turn it further so that the knob is horizontal. From this position, turn the dial 2 full turns counterclockwise.

#### 1. Turn the distortion ring to the left edge.

Lens shift dials

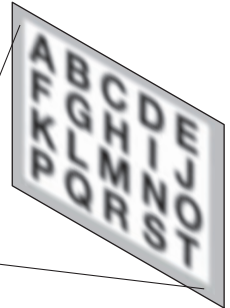
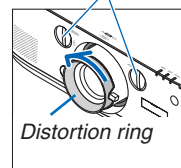

#### 2. Turn the focus lever clockwise and counterclockwise to adjust the focus at the center of the screen.

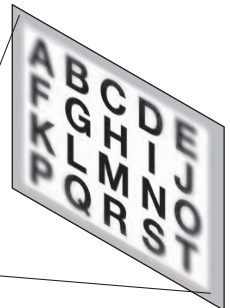
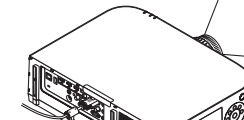
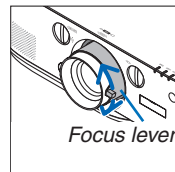

#### 3. Use the distortion ring to correct the screen's distortion.

(This also brings the edges of the screen into focus.)

#### 4. Use the focus lever to adjust the screen's overall focus.

\* If the focus at the center of the screen is off, turn the distortion ring a little counterclockwise. The focus at the center of the screen can now be adjusted with the focus lever.

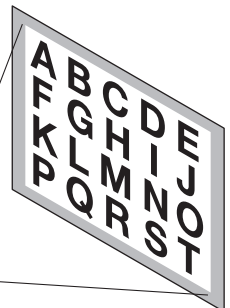
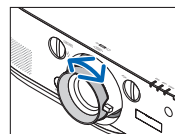

### Zoom

Turn the zoom lever or zoom ring clockwise and counterclockwise.

- The separately sold NP11FL lens does not have a zoom ring.

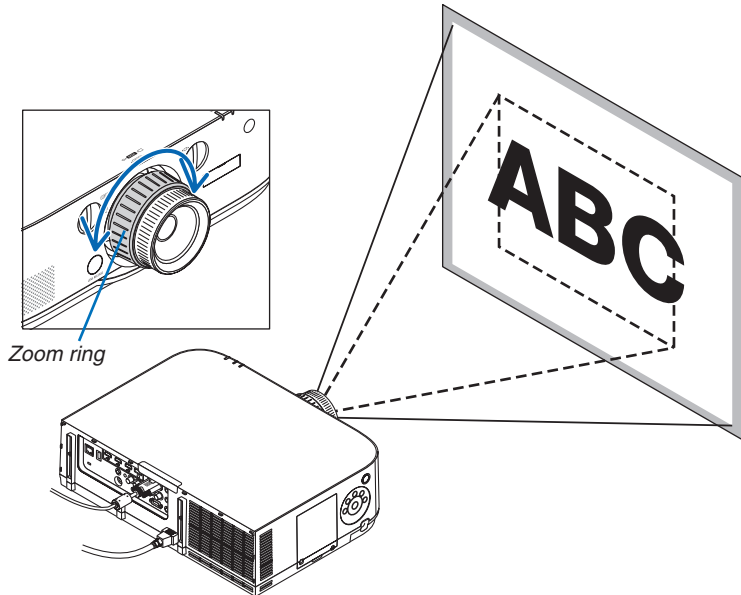

### Adjusting the Tilt Feet

#### 1. Turn the left and right tilt feet to adjust.

The tilt feet lengthen and shorten when turned.

The height of the projected image is adjusted by turning the left and right tilt feet.

If the projected image is tilted, turn one of the tilt feet to adjust the image so that it is level.

- If the projected image is distorted, see “3-6 Correcting Horizontal and Vertical Keystone Distortion [CORNERSTONE]” (→ page 35) and “[GEOMETRIC CORRECTION]” (→ page 102).
- The tilt feet can be lengthened by a maximum of 20 mm.
- The tilt feet can be used to tilt the projector by a maximum of 4°.

#### NOTE:

- Do not lengthen the tilt feet any more than 20 mm/0.8". Doing so will make the tilt feet's mount section unstable and could cause the tilt feet to come off the projector.
- Do not use the tilt feet for any purpose other than adjusting the projector's projection angle.  
Handling the tilt feet improperly, such as carrying the projector by grasping the tilt feet or hooking it onto a wall using the tilt feet, could damage the projector.

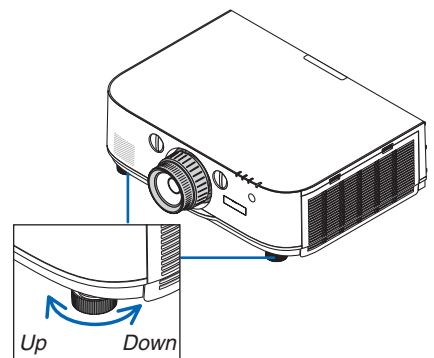
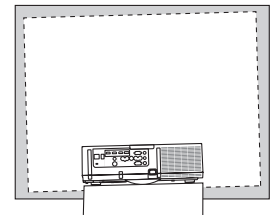

Tilt foot

### 6 Optimizing Computer Signal Automatically

#### Adjusting the Image Using Auto Adjust

When projecting a signal from the computer video input terminal, BNC video input terminal (analog RGB), HDMI 1 input terminal, HDMI 2 input terminal, DisplayPort input terminal (including the HDBaseT input signal), adjust the picture quality with a single touch of the button if the edges of the screen are cut off or if the projection quality is bad.

Press the AUTO ADJ. button to optimize a computer image automatically.

This adjustment may be necessary when you connect your computer for the first time.

[Poor picture]

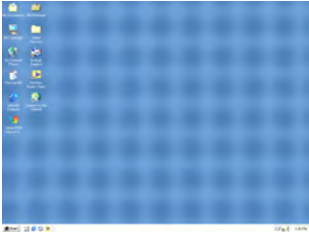

[Normal picture]

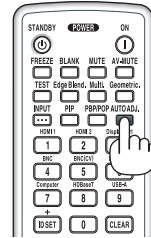
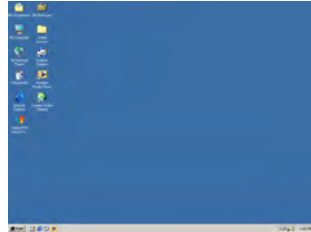

#### NOTE:

Some signals may take time to display or may not be displayed correctly.

- If the Auto Adjust operation cannot optimize the computer signal, try to adjust [HORIZONTAL], [VERTICAL], [CLOCK], and [PHASE] manually. (→ page 93, 94)

### 7 Turning Up or Down Volume

Sound level from the speaker can be adjusted.

#### Important:

- Do not turn up the volume to the maximum level on the external speaker system connected to the AUDIO OUT of the projector. Doing so may produce an unexpected, loud sound at the time of turning on or off the projector, causing damage to your hearing. When adjusting the volume on the external speaker system, set volume level of the speaker system to less than half its rating and adjust the volume on the projector to get appropriate sound level.

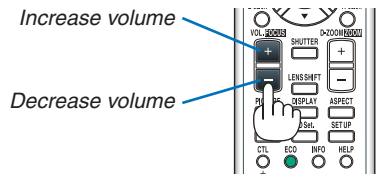
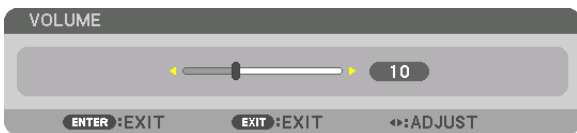

**TIP:** When no menus appear, the ◀ and ▶ buttons on the projector cabinet work as a volume control.

#### NOTE:

[HDBaseT Models]

- Volume control is not available with the ◀ or ▶ button when an image is enlarged by using the D-ZOOM (+) button or when the menu is displayed.

[MM Models]

- When the on-screen menu is displayed and the screen has been enlarged using the button, the volume cannot be adjusted using the button if the viewer or Ethernet (audio selection is Ethernet) is being displayed.

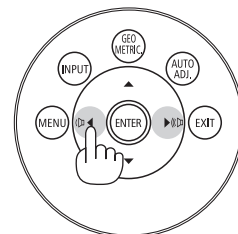



### 8 Turning off the Projector

To turn off the projector:

1. First, press the  (POWER) button on the projector cabinet or the STANDBY button on the remote control.

The [POWER OFF / ARE YOU SURE ? / CARBON SAVINGS- SESSION 0.000[g-CO2]] message will appear.

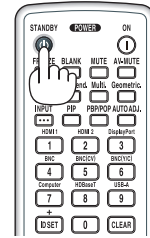
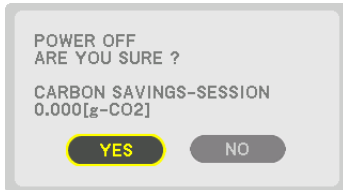

2. Secondly, press the ENTER button or press the  (POWER) or the STANDBY button again.

The lamp will go off and the power supply will be cut. At this point, if there are no input signals, the projector will go into the standby mode after about 10 seconds. When in standby mode, the POWER indicator will light red and the STATUS indicator will light off when [NORMAL] is selected for [STANDBY MODE].

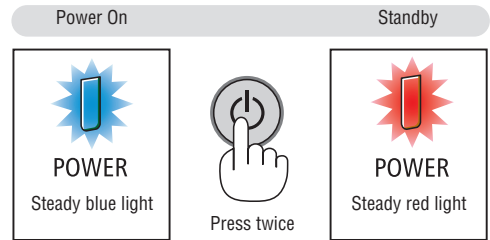

#### CAUTION:

Parts of the projector may become temporarily heated if the projector is turned off with the POWER button or if the AC power supply is disconnected during normal projector operation. Use caution when picking up the projector.

#### NOTE:

- While the POWER indicator is blinking blue in short cycles, the power cannot be turned off.
- You cannot turn off the power for 60 seconds immediately after turning it on and displaying an image.
- Do not unplug the power cord from the projector or from the power outlet while an image is being projected. Doing so could deteriorate the projector's AC IN terminal or the power plug's contact. To turn off the AC power while an image is being projected, use the power strip's switch, the breaker, etc.
- Do not disconnect the AC power supply to the projector within 10 seconds of making adjustment or setting changes and closing the menu. Doing so can cause loss of adjustments and settings.

### 9 After Use

Preparation: Make sure that the projector is turned off.

1. *Unplug the power cord.*
2. *Disconnect any other cables.*
3. *Mount the lens cap on the lens.*
4. *Before moving the projector, screw in the tilt feet if they have been lengthened.*

# 3. Convenient Features

## ① Turning off the Image and Sound

The projected video and the output sound from the internal speaker and sound output terminal will disappear momentarily.

### Press the **BLANK** button.

The projected video will be cut off.

### Press the **MUTE** button.

The projected audio will be cut off.

### Press the **AV-MUTE** button.

The projected video and audio will be cut off.

- Press the buttons one more time for the cancelled video and audio to appear again.  
When AV-MUTE and BLANK are continued for some time, the energy-saving function will activate to lower the lamp power.

---

#### NOTE:

- When the AV-MUTE and BLANK buttons are pressed immediately after the energy-saving function is activated, sometimes the brightness may not return to normal immediately.
- 

#### TIP:

- The video will disappear but not the menu display.

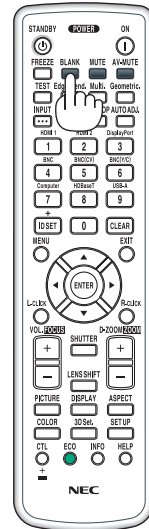

## 2 Freezing a Picture

Press the FREEZE button to freeze a picture. Press again to resume motion.

*NOTE: The image is frozen but the original video is still playing back.*

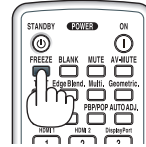

## 3 Enlarging a Picture

You can enlarge the picture up to four times.

*NOTE:*

- Depending on an input signal, the maximum magnification may be less than four times, or the function may be restricted.

To do so:

1. Press the D-ZOOM (+) button to magnify the picture.

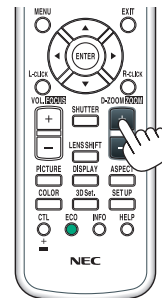
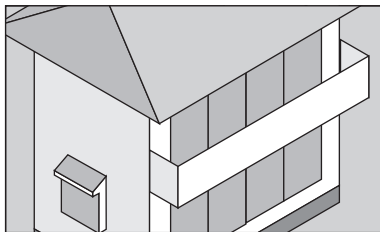
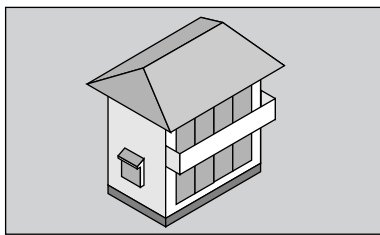

2. Press the ▲▼◀▶ button.

The area of the magnified image will be moved

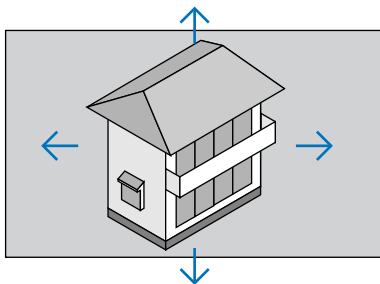

3. Press the D-ZOOM (-) button.

Each time the D-ZOOM (-) button is pressed, the image is reduced.

*NOTE:*

- The image will be enlarged or reduced at the center of the screen.
- Displaying the menu will cancel the current magnification.

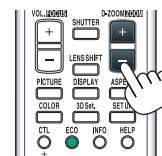

## ④ Changing Eco Mode/Checking Energy-Saving Effect Using Eco Mode [ECO MODE]

This feature enables you to select two brightness modes of the lamp: OFF and ON modes. The lamp life can be extended by turning on the [ECO MODE].

[ECO MODE]	Description
[OFF]	This is the default setting (100% Brightness).
[ON] 	Low lamp power consumption (approx. 80% Brightness).

To turn on the [ECO MODE], do the following:

1. Press the **ECO** button on the remote control to display [ECO MODE] screen.
2. Use the **▲** or **▼** button to select [ON].
3. Press the **ENTER** button.

To change from [ON] to [OFF], Go back to Step 2 and select [OFF]. Repeat Step 3.

### NOTE:

- The [ECO MODE] can be changed by using the menu.  
Select [SETUP] → [INSTALLATION] → [LAMP MODE] → [ECO MODE].
- The lamp life remaining and lamp hours used can be checked in [USAGE TIME]. Select [INFO.] → [USAGE TIME].
- [ECO MODE] is always set to [OFF] for 1 minute immediately after the lamp is turned on. The lamp condition will not be affected even when [ECO MODE] is changed.
- After a lapse of 1 minute from when the projector displays a blue, black or logo screen, [ECO MODE] will automatically switch to [ON].
- If the projector is overheated in [OFF] mode, there may be a case where the [ECO MODE] automatically changes to [ON] mode to protect the projector. This is called "Forced ECO Mode". When the projector is in the Forced Eco Mode, the picture brightness decreases slightly and the TEMP. indicator lights orange. At the same time the Thermometer symbol [  ] is displayed at the bottom right of the screen.  
When the projector comes back to normal temperature, the Forced Eco Mode is cancelled and the [ECO MODE] returns to [OFF] mode.

#### Checking Energy-Saving Effect [CARBON METER]

This feature will show energy-saving effect in terms of CO<sub>2</sub> emission reduction (kg) when the projector's [ECO MODE] is set to [OFF], or [ON]. This feature is called as [CARBON METER].

There are two messages: [TOTAL CARBON SAVINGS] and [CARBON SAVINGS-SESSION]. The [TOTAL CARBON SAVINGS] message shows the total amount of CO<sub>2</sub> emission reduction from the time of shipment up to now. You can check the information on [USAGE TIME] from [INFO.] of the menu. (→ page 133)



The [CARBON SAVINGS-SESSION] message shows the amount of CO<sub>2</sub> emission reduction between the time of changing to ECO MODE immediately after the time of power-on and the time of power-off. The [CARBON SAVINGS-SESSION] message will be displayed in the [POWER OFF/ ARE YOU SURE ?] message at the time of power-off.



#### TIP:

- The formula as shown below is used to calculate the amount of CO<sub>2</sub> emission reduction.  

$$\text{Amount of CO}_2 \text{ emission reduction} = (\text{Power consumption in OFF for ECO MODE} - \text{Power consumption in ON for ECO MODE}) \times \text{CO}_2 \text{ conversion factor.}$$
 \* When the image is turned off with the AV-MUTE button the amount of CO<sub>2</sub> emission reduction will also increase.  
 \* Calculation for amount of CO<sub>2</sub> emission reduction is based on an OECD publication "CO<sub>2</sub> Emissions from Fuel Combustion, 2008 Edition".
- The [TOTAL CARBON SAVINGS] is calculated based on savings recorded in 15 minutes intervals.
- This formula will not apply to the power consumption which is not affected by whether [ECO MODE] is turned on or off.

## 5 Using the Optional Remote Mouse Receiver (NP01MR)

The optional remote mouse receiver enables you to operate your computer's mouse functions from the remote control. It is a great convenience for clicking through your computer-generated presentations.

### Connecting the remote mouse receiver to your computer

If you wish to use the remote mouse function, connect the mouse receiver and computer.

The mouse receiver can be connected directly to the computer's USB port (type A).

---

*NOTE: Depending on the type of connection or OS installed on your computer, you may have to restart your computer or change your computer settings.*

---

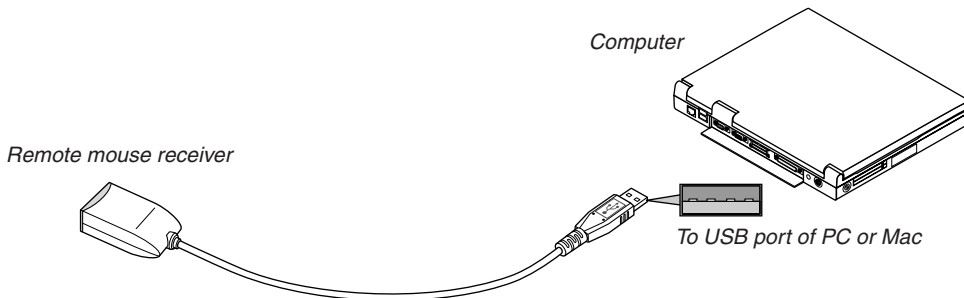

### When operating a computer via the remote mouse receiver

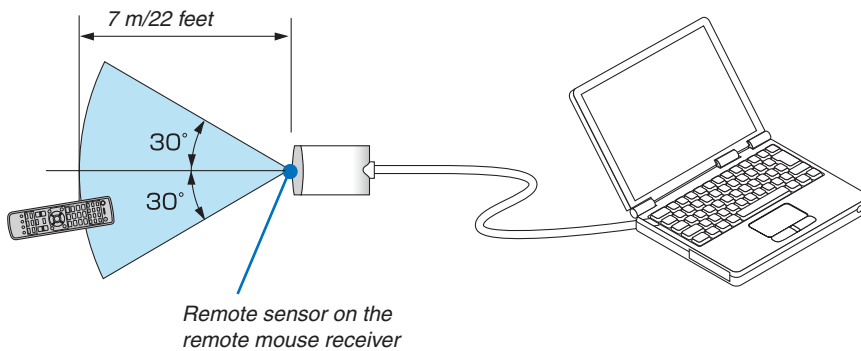

### When connecting using the USB terminal

For PC, the mouse receiver can only be used with a Windows XP\*, Windows Vista, Windows 7, or Mac OS X 10.0.0 or later operating system.

---

*\* NOTE: In SP1 or older version of Windows XP, if the mouse cursor will not move correctly, do the following: Clear the Enhance pointer precision check box underneath the mouse speed slider in the Mouse Properties dialog box [Pointer Options tab].*

---

---

*NOTE: When using PowerPoint for Mac OS, the CTL button and the page ▼/▲ buttons (page up and down) on the remote control will be disabled.*

---

---

*NOTE: Wait at least 5 seconds after disconnecting the mouse receiver before reconnecting it and vice versa. The computer may not identify the mouse receiver if it is repeatedly connected and disconnected in rapid intervals.*

---

#### Operating your computer's mouse from the remote control

You can operate your computer's mouse from the remote control.

CTL Button + PAGE ▼/▲ Button

..... scrolls the viewing area of the window or to move to the previous or next slide in PowerPoint on your computer.

▲▼◀▶ Buttons.... moves the mouse cursor on your computer.

L-CLICK Button..... works as the mouse left button.

R-CLICK Button ..... works as the mouse right button.

---

#### NOTE:

- When you operate the computer using the ▲▼◀ or ▶ button with the menu displayed, both the menu and the mouse pointer will be affected. Close the menu and perform the mouse operation.
  - When using PowerPoint for Mac OS, the CTL button and the page ▼/▲ buttons (page up and down) on the remote control will be disabled.
- 

#### About Drag Mode:

By pressing the L-CLICK or R-CLICK button for 2 or 3 seconds then releasing, the drag mode is set and the drag operation can be performed simply by pressing the ▲▼◀▶ button. To drop the item, press the L-CLICK (or R-CLICK) button. To cancel it, press the R-CLICK (or L-CLICK) button.

*TIP: You can change the Pointer speed on the Mouse Properties dialog box on the Windows. For more information, see the user documentation or online help supplied with your computer.*



## ⑥ Correcting Horizontal and Vertical Keystone Distortion [CORNERSTONE]

Use the [CORNERSTONE] feature to correct keystone (trapezoidal) distortion to make the top or bottom and the left or right side of the screen longer or shorter so that the projected image is rectangular.

1. **Press and hold the Geometric. button for a minimum of 2 seconds to reset current adjustments.**

*Current adjustments for [GEOMETRIC CORRECTION] will be cleared.*

2. **Project an image so that the screen is smaller than the area of the raster.**

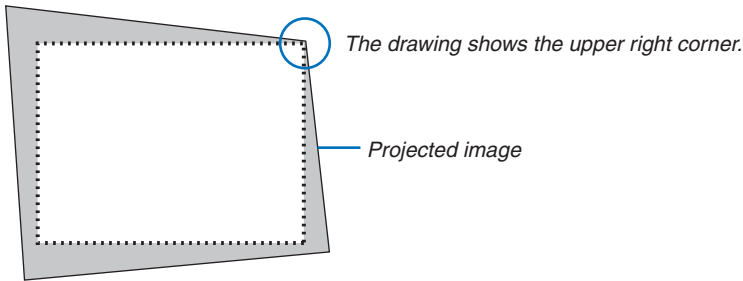

3. **Pick up any one of the corners and align the corner of the image with a corner of the screen.**

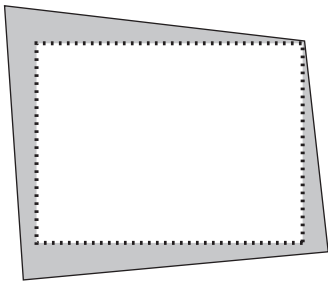

4. **Press the Geometric. button.**

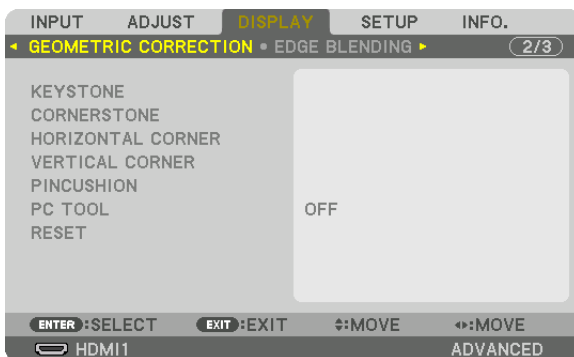

Display the [GEOMETRIC CORRECTION] screen of the on-screen menu.

5. Press the ▼ button to align with the [CORNERSTONE] and then press the ENTER button.



The drawing shows the upper left icon (▼) is selected.

The screen will switch to the [CORNERSTONE] screen.

NOTE:

- When a [GEOMETRIC CORRECTION] function other than [CORNERSTONE] has been set up, the [CORNERSTONE] screen will not be displayed. When the screen is not displayed, either press the Geometric. button for 2 or more seconds, or run [RESET] in [GEOMETRIC CORRECTION] to clear the adjustment value of [GEOMETRIC CORRECTION].

6. Use the ▲▼◀▶ button to select one icon (▲) which points in the direction you wish to move the projected image frame.

7. Press the ENTER button.

8. Use the ▲▼◀▶ button to move the projected image frame as shown on the example.

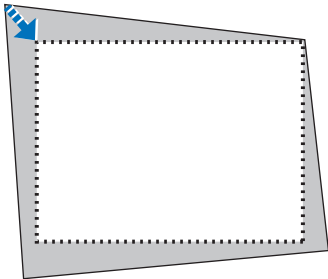

9. Press the ENTER button.

10. Use the ▲▼◀▶ button to select another icon which points in the direction.

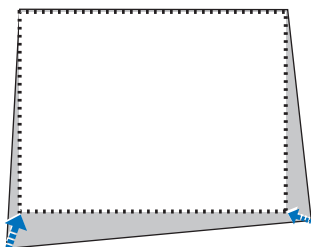

On the [CORNERSTONE] screen, select [EXIT] or press the EXIT button on the remote control.

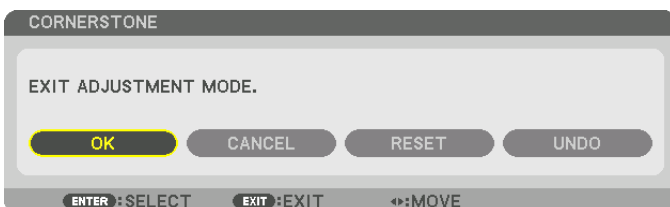

The confirmation screen is displayed.

**11. Press the ◀ or ▶ button to highlight the [OK] and press the ENTER button.**

*This completes the [CORNERSTONE] correction.*

- *Select [CANCEL] and press the ENTER button to return to the [CORNERSTONE] screen.*

Selecting [CANCEL] will return to the adjustment screen without saving changes (Step 3).

Selecting [RESET] will return to the factory default.

Selecting [UNDO] will exit without saving changes.

---

**NOTE:**

- *Even when the projector is turned on, the last used correction values are applied.*
  - *Carry out either one of the following actions to clear the adjustment value of [CORNERSTONE].*
    - *In Step 11, select [RESET] and then press the ENTER button.*
    - *Press the Geometric. button for 2 or more seconds.*
    - *Run [DISPLAY] → [GEOMETRIC CORRECTION] → [RESET] in the on-screen menu.*
  - *Using CORNERSTONE correction can cause the image to be slightly blurred because the correction is made electronically.*
-

## 7 Preventing the Unauthorized Use of the Projector [SECURITY]

A keyword can be set for your projector using the Menu to avoid operation by an unauthorized user. When a keyword is set, turning on the projector will display the Keyword input screen. Unless the correct keyword is entered, the projector cannot project an image.

- The [SECURITY] setting cannot be cancelled by using the [RESET] of the menu.

To enable the Security function:

**1. Press the MENU button.**

The menu will be displayed.

**2. Press the ► button twice to select [SETUP] and press the ▼ button or the ENTER button to select [MENU].**

**3. Press the ► button to select [CONTROL].**

**4. Press the ▼ button three times to select [SECURITY] and press the ENTER button.**

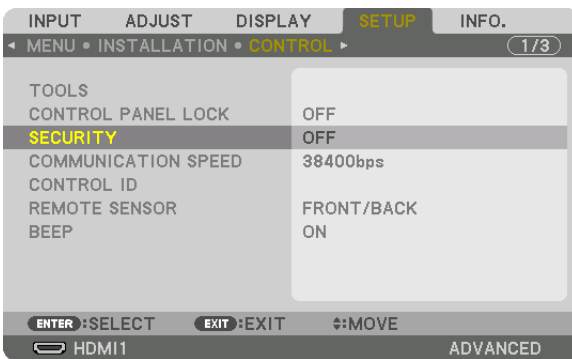

The OFF/ON menu will be displayed.

**5. Press the ▼ button to select [ON] and press the ENTER button.**

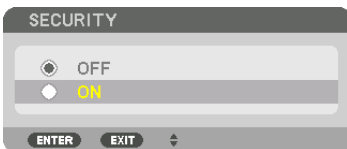

The [SECURITY KEYWORD] screen will be displayed.

**6. Type in a combination of the four ▲▼◀▶ buttons and press the ENTER button.**

*NOTE: A keyword must be 4 to 10 digits in length.*



The [CONFIRM KEYWORD] screen will be displayed.

*NOTE: Make a note of your password and store it in a safe place.*

7. Type in the same combination of ▲▼◀▶ buttons and press the ENTER button.

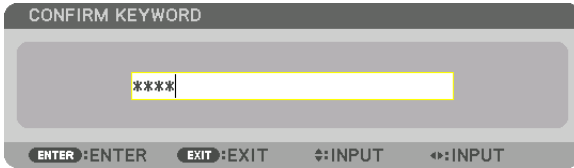

The confirmation screen will be displayed.

8. Select [YES] and press the ENTER button.



The SECURITY function has been enabled.

To turn on the projector when [SECURITY] is enabled:

1. Press the POWER button.

The projector will be turned on and display a message to the effect that the projector is locked.

2. Press the MENU button.

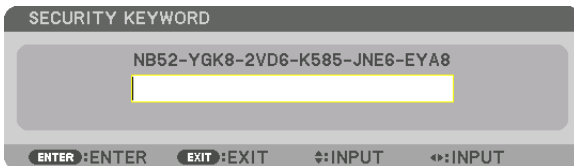

3. Type in the correct keyword and press the ENTER button. The projector will display an image.

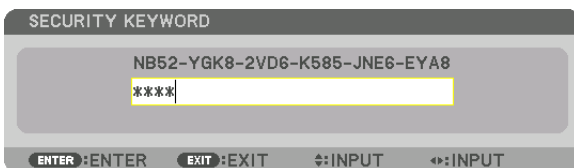

---

NOTE: The security disable mode is maintained until the main power is turned off or unplugging the power cord.

To disable the SECURITY function:

**1. Press the MENU button.**

The menu will be displayed.

**2. Select [SETUP] → [CONTROL] → [SECURITY] and press the ENTER button.**

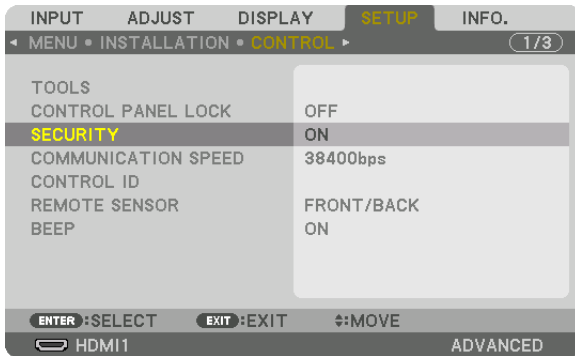

The OFF/ON menu will be displayed.

**3. Select [OFF] and press the ENTER button.**

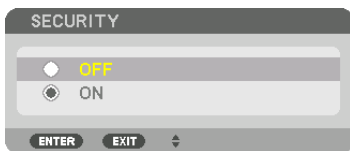

The SECURITY KEYWORD screen will be displayed.

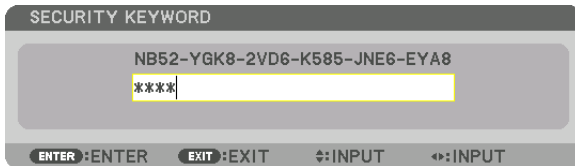

**4. Type in your keyword and press the ENTER button.**

When the correct keyword is entered, the SECURITY function will be disabled.

---

*NOTE: If you forget your keyword, contact your dealer. Your dealer will provide you with your keyword in exchange for your request code. Your request code is displayed in the Keyword Confirmation screen. In this example [NB52-YGK8-2VD6-K585-JNE6-EYA8] is a request code.*

---

## 8 Projecting 3D videos

This projector can be used to watch videos in 3D using commercially-available active shutter-type 3D eyewear. In order to synchronize the 3D video and eyewear, a commercially-available 3D emitter needs to be connected to the projector (on the projector side).

The 3D eyewear receives information from the 3D emitter and performs opening and closing on the left and right.

### CAUTION

#### Health precautions

Before use, please make sure to read any health precautions that may be stated in the operating manuals enclosed with the 3D eyewear and 3D video software (Blu-ray player, games, computer animation files, etc.).

Please take note of the following in order to avoid adverse health effects.

- Please do not use the 3D eyewear for purposes other than to watch 3D videos.
- Please keep a distance of at least 2 m away from the screen when watching videos. Watching a video too close to the screen will increase eye fatigue.
- Please do not watch videos continuously for a long period of time. Please take a 15 minutes' break after every hour of watching.
- Please consult a doctor before watching if you or any of your family members have a history of suffering from seizures caused by light sensitivity.
- Please stop watching immediately and take a rest when you feel physically unwell while watching (vomiting, giddiness, nausea, headaches, sore eyes, blurred vision, cramps and numbness in the limbs, etc.). Please consult a doctor if the symptoms persist.
- Please watch a 3D video directly in front of the screen. If you watch a 3D video obliquely from the sides, this may result in physical and eye fatigue.

#### 3D eyewear and 3D emitter preparations

Please use an active shutter-type 3D eyewear that conforms with the VESA standard.

A commercially-available RF type made by Xpand is recommended.

3D eyewear..... Xpand X105-RF

3D emitter..... Xpand AD025-RF-X1

#### Procedure to watch 3D videos using this projector

1. **Connect the video device to the projector.**
2. **Switch on the power supply to the projector.**
3. **Run the 3D video software and project the video using the projector.**

*This has been automatically set up when shipped from the factory. When a 3D video cannot be projected, it may be because the 3D detection signals are not included or because they are not detectable by the projector.*

*Please manually select the format.*

4. **Select the 3D video format.**

(1) Press the "3D Set." button on the remote control.

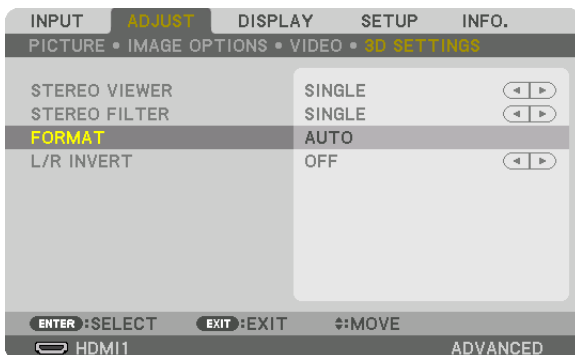

The [3D SETTINGS] screen will be displayed.

(2) Press the ▼ button to align the cursor with the [FORMAT] and press the ENTER button.

The format screen will be displayed.

(3) Select the input signal format using the ▼ button and then press the ENTER button.

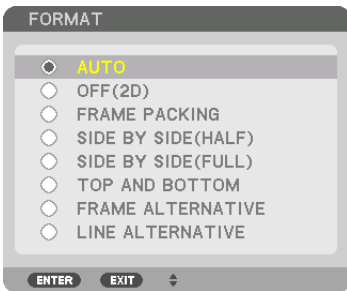

The 3D settings screen will disappear and the 3D video will be projected.

Press the MENU button and the on-screen menu will disappear.

The 3D caution message screen will be displayed when switching to a 3D video (default factory setting when shipped). Please read the “Health Precautions” on the previous page to watch videos in the correct manner. The screen will disappear after 60 seconds or when the ENTER button is pressed. (→ page 110)

#### 5. Turn on the power supply of the 3D eyewear and wear the eyewear to watch the video.

A normal video will be shown when a 2D video is input.

To watch a 3D video in 2D, select [OFF(2D)] in the [FORMAT] screen mentioned above in (3).

---

#### NOTE:

- Upon switching to 3D image, the following functions will be cancelled and disabled. [BLANKING], [PIP/PICTURE BY PICTURE], [GEOMETRIC CORRECTION], [EDGE BLENDING] ([GEOMETRIC CORRECTION] and [EDGE BLENDING] adjustment values will be maintained.)
  - The output may not automatically switch to a 3D video depending on the 3D input signal.
  - Check the operating conditions described in the user manual of the Blu-ray player.
  - Please connect the DIN terminal of the 3D emitter to the 3D SYNC of the main projector.
  - The 3D eyewear allows videos to be viewed in 3D by receiving synchronized optical signals output from the 3D emitter. As a result, the 3D image quality may be affected by conditions such as the brightness of the surroundings, screen size, viewing distance, etc.
  - When playing a 3D video software on a computer, the 3D image quality may be affected if the computer CPU and graphics chip performance are low. Please check the required operating environment of the computer that is stated in the operating manual attached to the 3D video software.
  - Depending on the signal, [FORMAT] and [L/R INVERT] may not be able to be selected. Please change the signal in that case.
-



#### When videos cannot be viewed in 3D

Please check the following points when videos cannot be viewed in 3D.

Please also read the operating manual attached to the 3D eyewear.

Possible reasons	Solutions
The selected signal does not support 3D output.	Please change the video signal input to one that supports 3D.
The format for the selected signal is turned to [OFF(2D)].	Please change the format in the on-screen menu to [AUTO] or a format that supports 3D.
A eyewear that is not supported by the projector is being used.	Please purchase a commercially-available 3D eyewear or 3D emitter (recommended). (→ page 41)
Please check the following points when a video cannot be viewed in 3D using a 3D eyewear that is supported by the projector.	
The power supply of the 3D eyewear is turned off.	Please turn on the power supply of the 3D eyewear.
The internal battery of the 3D eyewear is flat.	Please charge or replace the battery.
The viewer is located too far away from the screen.	Please get closer to the screen until the video can be seen in 3D. Please turn the L/R INVERT in the on-screen menu to [OFF].
Due to multiple 3D projectors working at the same time in the vicinity, the projectors may interfere with one another. Alternatively, there may be a bright light source near the screen.	Please maintain sufficient distance between the projectors.
	Please keep the light source away from the screen.
	Please turn the L/R INVERT in the on-screen menu to [OFF].
There is an obstacle between the optical receiver of the 3D eyewear and the 3D emitter.	Please remove the obstacle.
The 3D format of the 3D video contents is not supported.	Please check with the company selling the 3D video contents.

## 9 Controlling the Projector by Using an HTTP Browser

### Overview

Using the web browser on the computer, the HTTP server screen of the projector can be displayed to operate the projector.

For the HTTP server screen of the projector, there is the basic HTTP server screen (common to both HDBaseT models and MM models) and the dedicated HTTP server screen for MM models.

### Possible operations on the HTTP server screen

#### (1) Possible operations on the basic HTTP server screen (common to both HDBaseT models and MM models)

- When using the following functions, configure the settings required for connecting the projector to the network (wired LAN). (NETWORK SETTINGS)
  - PC Control Utility Pro 4/Pro 5
  - Virtual Remote Tool
- Configure the email notification. (ALERT MAIL)

When the projector is connected to a network (wired LAN), notifications on the lamp replacement period and various errors are sent to the email address that has been set up.

- Operate the projector.  
Operations such power on/off of the projector, input terminal switchover, volume control, picture control etc. can be carried out.
- Configure the [PJLink PASSWORD] and [AMX BEACON] etc.

#### (2) Possible operations on the dedicated HTTP server screen for MM models

- When using the following functions on the MM models, configure the settings required to connect the projector to the network (wired LAN/wireless LAN).
  - Image Express Utility Lite
  - Image Express Utility 2.0
  - Desktop Control Utility 1.0
  - Network Projector
  - Remote Desktop
  - Viewer (when a shared folder/media server is used)

### To view the HTTP server screen

#### (1) Basic HTTP server screen (common to both HDBaseT models and MM models)

1. **Connect the projector to the computer with a LAN cable sold commercially.** (→ page 169)
2. **Select [SETUP] → [NETWORK SETTINGS] → [WIRED LAN] in the on-screen menu to configure the network settings.** (→ page 122)
3. **Start up the web browser on your computer and enter the address or URL in the input field.**  
Specify the address or URL as “http://<IP Address of Projector>/index.html”.  
The basic HTTP server screen will be displayed.

#### (2) HTTP server screen for MM models only

1. **Connect the projector to the computer with a LAN cable sold commercially.** (→ page 169) **Alternatively, install a wireless LAN unit sold separately.** (→ page 170)
2. **Select [INPUT TERMINAL] → [ETHERNET] in the on-screen menu.**  
The application menu will be displayed.
3. **Select “NETWORK SETTINGS (MM)” and configure the network settings.** (→ page 138)

#### TIP:

- If you want to set the IP address here, set a different IP address in the same segment as the IP address that has been set up in the basic HTTP server screen.

#### 4. Start up the web browser on your computer and enter the address or URL in the input field.

Specify the address or URL as “http://<IP Address of Projector (MM)>/index.html”.

The HTTP server screen for MM models only will be displayed.

*TIP: The factory setting IP address is [DHCP ON].*

---

#### NOTE:

- To use the projector in a network, consult with your network administrator about network settings.
  - The display's or button's response can be slowed down or operation may not be accepted depending the settings of your network.  
*Should this happen, consult your network administrator. The projector may not respond if its buttons are repeatedly pressed in rapid intervals. Should this happen, wait a moment and repeat. If you still can't get any response, turn off and back on the projector.*
  - If the PROJECTOR NETWORK SETTINGS screen does not appear in the web browser, press the Ctrl+F5 keys to refresh your web browser (or clear the cache).
  - This projector uses “JavaScript” and “Cookies” and the browser should be set to accept these functions. The setting method will vary depending on the version of browser. Please refer to the help files and the other information provided in your software.
- 

#### Preparation before Use

Connect the projector to a commercially available LAN cable before engaging in browser operations. (→ page 169)  
Operation with a browser that uses a proxy server may not be possible depending on the type of proxy server and the setting method. Although the type of proxy server will be a factor, it is possible that items that have actually been set will not be displayed depending on the effectiveness of the cache, and the contents set from the browser may not be reflected in operation. It is recommended that a proxy server not be used unless it is unavoidable.

#### Handling of the Address for Operation via a Browser

Regarding the actual address that is entered for the address or entered to the URL column when operation of the projector is via a browser, the host name can be used as it is when the host name corresponding to the IP address of the projector has been registered to the domain name server by a network administrator, or the host name corresponding to the IP address of the projector has been set in the “HOSTS” file of the computer being used.

Example 1: When the host name of the projector has been set to “pj.nec.co.jp”, access is gained to the network setting by specifying  
<http://pj.nec.co.jp/index.html>  
 for the address or the entry column of the URL.

Example 2: When the IP address of the projector is “192.168.73.1”, access is gained to the network setting by specifying  
<http://192.168.73.1/index.html>  
 for the address or the entry column of the URL.

#### PROJECTOR ADJUSTMENT

Projector adjustment screen for HDBaseT models

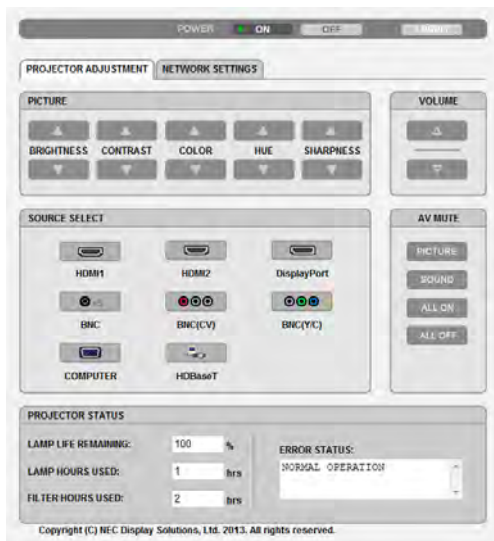

Projector adjustment screen for MM models

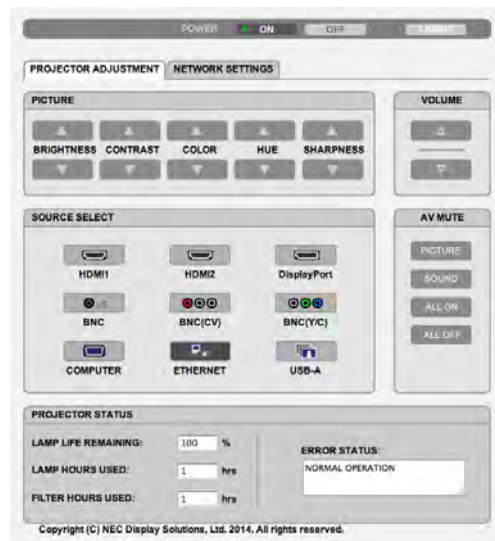

**POWER:** This controls the power of the projector.

ON ..... Power is switched on.

OFF ..... Power is switched off.

**VOLUME:** This controls the volume of the projector.

▲ ..... Increases the volume adjustment value.

▼ ..... Decreases the volume adjustment value.

**AV-MUTE:** This controls the mute function of the projector.

PICTURE ON ..... Mutes the video.

PICTURE OFF ..... Cancels the video muting.

SOUND ON ..... Mutes the audio.

SOUND OFF ..... Cancels the audio muting.

ALL ON ..... Mutes each of the video, and audio functions.

ALL OFF ..... Cancels the muting of each of the video, and audio functions.

**PICTURE:** Controls the video adjustment of the projector.

BRIGHTNESS ▲ .... Increases the brightness adjustment value.

BRIGHTNESS ▼ .... Decreases the brightness adjustment value.

CONTRAST ▲ ..... Increases the contrast adjustment value.

CONTRAST ▼ ..... Decreases the contrast adjustment value.

COLOR ▲ ..... Increases the color adjustment value.

COLOR ▼ ..... Decreases the color adjustment value.

HUE ▲ ..... Increases the hue adjustment value.

HUE ▼ ..... Decreases the hue adjustment value.

SHARPNESS ▲ .... Increases the sharpness adjustment value.

SHARPNESS ▼ .... Decreases the sharpness adjustment value.

- The functions that can be controlled will vary depending on the signal being input to the projector. (→ page 91, 92)

**SOURCE SELECT:** This switches the input connector of the projector.

HDMI1 ..... Switches to the HDMI 1 IN connector.

HDMI2 ..... Switches to the HDMI 2 IN connector.

DisplayPort ..... Switches to the DisplayPort.

BNC ..... Switch to BNC (analog RGB) video input.

BNC(CV) ..... Switch to BNC (CV) video input.

BNC(Y/C) ..... Switch to BNC (Y/C) video input.

COMPUTER ..... Switches to the COMPUTER IN connector.

[HDBaseT Models]

HDBaseT ..... Switch to image input sent from a transmission device that supports HDBaseT.

[MM Models]

ETHERNET ..... Switch to the data display that is sent from the network.

USB-A ..... Switch to the data display of the USB memory that has been set up in the projector.

**PROJECTOR STATUS:** This displays the condition of the projector.

LAMP LIFE REMAINING ..... Displays the remaining life of the lamp as a percentage.

LAMP HOURS USED ..... Displays how many hours the lamp has been used.

FILTER HOURS USED ..... Displays how many hours the filter has been used.

ERROR STATUS ..... Displays the status of errors occurring within the projector.

**LOG OFF:** Logging off your projector and returning to the authentication screen (LOGON screen).

## NETWORK SETTINGS

http://<IP Address of Projector (Basic)>/index.html

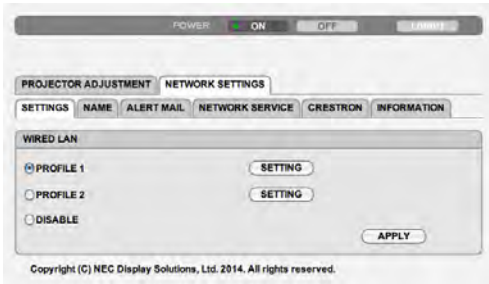

### • SETTINGS

#### WIRED

SETTING	Set for wired LAN.
APPLY	Apply your settings to wired LAN.
PROFILE 1/PROFILE 2	Two settings can be set for wired LAN connection. Select PROFILE 1 or PROFILE 2.
DISABLE	Turn off wired LAN connection
DHCP ON	Automatically assign IP address, subnet mask, and gateway to the projector from your DHCP server.
DHCP OFF	Set IP address, subnet mask, and gateway to the projector assigned by your network administrator.
IP ADDRESS	Set your IP address of the network connected to the projector.
SUBNET MASK	Set your subnet mask number of the network connected to the projector.
GATEWAY	Set the default gateway of the network connected to the projector.
AUTO DNS ON	DHCP server will automatically assign IP address of DNS server connected to the projector.
AUTO DNS OFF	Set your IP address of DNS server connected to the projector.

#### • NAME

PROJECTOR NAME	Enter a name for your projector so that your computer can identify the projector. A projector name must be 16 characters or less. TIP: Projector name will not be affected even when [RESET] is done from the menu.
HOST NAME	Enter the hostname of the network connected to the projector. A host name must be 15 or less.
DOMAIN NAME	Enter the domain name of the network connected to the projector. A domain name must be 60 characters or less.

#### • ALERT MAIL

ALERT MAIL	This option will notify your computer of lamp replace time or error messages via e-mail when using wired LAN. Placing a checkmark will turn on the Alert Mail feature. Clearing a checkmark will turn off the Alert Mail feature. Sample of a message to be sent from the projector: The lamp and filters are at the end of its usable life. Please replace the lamp and filters. Projector Name: NEC Projector Lamp Hours Used: 100 [H]
SENDER'S ADDRESS	Enter sender's address.
SMTP SERVER NAME	Enter the SMTP server name to be connected to the projector.
RECIPIENT'S ADDRESS 1, 2, 3	Enter your recipient's address. Up to three addresses can be entered.
TEST MAIL	Send a test mail to check whether your settings are correct or not <i>NOTE:</i> <ul style="list-style-type: none"> <li>• If you execute a test, you may not receive an Alert mail. Should this happen, check if network settings are correct.</li> <li>• If you entered an incorrect address in a test, you may not receive an Alert mail. Should this happen, check if the Recipient's Address is correct.</li> </ul>
SAVE	Click this button to save your settings to the projector's memory.

#### • NETWORK SERVICE

PJLink PASSWORD	Set a password for PJLink*. A password must be 32 characters or less. Do not forget your password. However, if you forget your password, consult with your dealer.
HTTP PASSWORD	Set a password for HTTP server. A password must be 10 characters or less. When a password is set up, you will be prompted for your user name (arbitrary) and password during LOGON.
AMX BEACON	Turn on or off for detection from AMX Device Discovery when connecting to the network supported by AMX's NetLinx control system. <i>TIP:</i> <i>When using a device that supports AMX Device Discovery, all AMX NetLinx control system will recognize the device and download the appropriate Device Discovery Module from an AMX server. Placing a checkmark will enable detecting the projector from AMX Device Discovery. Clearing a checkmark will disable detecting the projector from AMX Device Discovery.</i>

*NOTE: If you forget your password, contact your dealer.*

#### \*What is PJLink?

PJLink is a standardization of protocol used for controlling projectors of different manufacturers. This standard protocol is established by Japan Business Machine and Information System Industries Association (JBMA) in 2005. The projector supports all the commands of PJLink Class 1. Setting of PJLink will not be affected even when [RESET] is done from the menu.

#### • CRESTRON

##### ROOMVIEW for managing from the computer.

DISABLE	Disables ROOMVIEW.
ENABLE	Enables ROOMVIEW.

##### CRESTRON CONTROL for managing from the controller.

DISABLE	Disables CRESTRON CONTROL.
ENABLE	Enables CRESTRON CONTROL.
IP ADDRESS	Set your IP address of CRESTRON SERVER.
IP ID	Set your IP ID of CRESTRON SERVER.

*TIP: The CRESTRON settings are required only for use with CRESTRON ROOMVIEW.*

*For more information, visit <http://www.crestron.com>*

#### • INFORMATION

WIRED LAN	Display a list of settings of wired LAN connection.
UPDATE	Reflect settings when they are changed.



**NETWORK SETTINGS (MM Models)**

http://<IP Address of Projector (MM)>/index.html

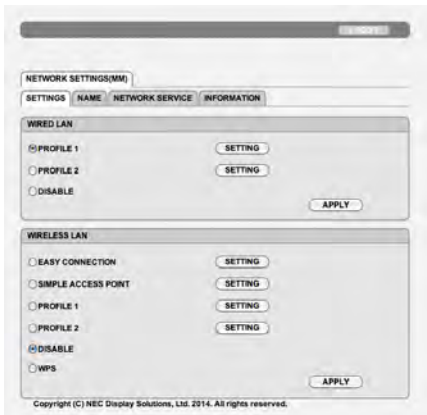

• **SETTINGS**

**WIRED or WIRELESS**

SETTING	Set for wired LAN or for wireless LAN.
APPLY	Apply your settings to wired LAN or wireless LAN.
DISABLE	Turn off wired LAN connection
PROFILE 1/PROFILE 2	Two settings can be set for wired LAN connection. Select PROFILE 1 or PROFILE 2.
DHCP ON	Automatically assign IP address, subnet mask, and gateway to the projector from your DHCP server.
DHCP OFF	Set IP address, subnet mask, and gateway to the projector assigned by your network administrator.
IP ADDRESS	Set your IP address of the network connected to the projector.
SUBNET MASK	Set your subnet mask number of the network connected to the projector.
GATEWAY	Set the default gateway of the network connected to the projector.
WINS	Set the IP address of your WINS server of the network connected to the projector when [DHCP] is turned on, this option is not available.
AUTO DNS ON	DHCP server will automatically assign IP address of DNS server connected to the projector.
AUTO DNS OFF	Set your IP address of DNS server connected to the projector.

**Setting for WIRELESS LAN (the optional Wireless LAN Unit required)**

EASY CONNECTION	Execute a wireless LAN using EASY CONNECTION.
SIMPLE ACCES POINT	Set the projector for simple access point.
WPS	Use WPS (Wi-Fi Protected Setup™) to set up the wireless LAN for the projector. <i>NOTE:</i> • Use the projector's menus to make WPS connections and change the WPS profile settings.
CHANNEL	Select a channel. Available channels vary depending on the country and region. When you select [INFRASTRUCTURE], make sure that the projector and your access point are on the same channel; when you select [AD HOC], make sure that the projector and your computer are on the same channel.
SSID	Enter an identifier (SSID) for wireless LAN. Communication can be done only with equipment whose SSID matches SSID for your wireless LAN.

### 3. Convenient Features

SITE SURVEY	Displays a list of available SSIDs for wireless LAN on site. Select an SSID which you can access.		
NETWORK TYPE	Select communication method when using wireless LAN. INFRASTRUCTURE: Select this option when communicating with one or more equipment connected to the wireless LAN network via a wireless access point. AD HOC: Select this option when using the wireless LAN to directly communicate with a computer in peer-to-peer mode.		
SECURITY TYPE	Turn on or off the encryption mode for secure transmission. When turn on the encryption mode, set WEP key or encrypted key.		
	DISABLE	Will not turn on the encryption feature. Your communications may be monitored by someone.	
	WEP 64 bit	Uses 64-bit datalength for secure transmission.	
	WEP 128 bit	Uses 128-bit datalength for secure transmission. This option will increase privacy and security when compared to use of 64-bit datalength encryption.	
	WPA-PSK TKIP / WPA-PSK AES/ WPA2-PSK TKIP / WPA2-PSK AES/ WPA-EAP TKIP EAP-TLS/ WPA-EAP AES EAP-TLS/ WPA-EAP TKIP PEAP-MSCHAP v2/ WPA-EAP AES PEAP-MSCHAP v2/ WPA2-EAP TKIP EAP-TLS/ WPA2-EAP AES EAP-TLS/ WPA2-EAP TKIP PEAP-MSCHAP v2/ WPA2-EAP AES PEAP-MSCHAP v2	These options provide stronger security than WEP.	
<p><i>NOTE:</i></p> <ul style="list-style-type: none"> <li>• The WEP settings must be the same as communication devices such as PC or access point in your wireless network.</li> <li>• When you use WEP, your image transmission speed will slow down.</li> <li>• Other encryption keys than WEP 64bit and WEP 128bit are not available when [AD HOC] is selected from [NETWORK TYPE].</li> <li>• To install a digital certificate, use the projector's menu. (→ page 145)</li> </ul>			
INDEX	Select encryption key when selecting [WEP 64 bit] or [WEP 128 bit] in [SECURITY TYPE].		
KEY	When selecting [WEP 64 bit] or [WEP 128 bit] in [SECURITY TYPE]: Enter WEP key.		
	Select	Characters (ASCII)	Hexadecimal digit (HEX)
	WEP 64 bit	Up to 5 characters	Up to 10 characters
	WEP 128 bit	Up to 13 characters	Up to 26 characters
When selecting [WPA PSK-TKIP], [WPA PSK-AES], [WPA2 PSK-TKIP] or [WPA2 PSK-AES]: Enter encryption key. Key length must be 8 or greater and 63 or less.			
USERNAME	Set a user name for WPA-EAP/WPA2-EAP.		
PASSWORD	Set a password for WPA-EAP TKIP PEAP-MSCHAP v2/WPA-EAP AES PEAP-MSCHAP v2/WPA2-EAP TKIP PEAP-MSCHAP v2/WPA2-EAP AES PEAP-MSCHAP v2.		
USE DIGITAL CERTIFICATE	Select this if you use a digital certificate for WPA-EAP TKIP PEAP-MSCHAP v2/WPA-EAP AES PEAP-MSCHAP v2/WPA2-EAP TKIP PEAP-MSCHAP v2/WPA2-EAP AES PEAP-MSCHAP v2.		

#### • NAME

HOST NAME	Enter the hostname of the network connected to the projector. A host name must be 15 or less.
-----------	---

#### • NETWORK SERVICE

HTTP PASSWORD	Set a password for HTTP server. A password must be 10 characters or less.
---------------	---

#### • CRESTRON

##### ROOMVIEW for managing from the computer.

DISABLE	Disables ROOMVIEW.
ENABLE	Enables ROOMVIEW.

##### CRESTRON CONTROL for managing from the controller.

DISABLE	Disables CRESTRON CONTROL.
ENABLE	Enables CRESTRON CONTROL.
IP ADDRESS	Set your IP address of CRESTRON SERVER.
IP ID	Set your IP ID of CRESTRON SERVER.

*TIP: The CRESTRON settings are required only for use with CRESTRON ROOMVIEW.*

*For more information, visit <http://www.crestron.com>*

#### • INFORMATION

WIRED LAN	Display a list of settings of wired LAN connection.
WIRELESS LAN	Display a list of settings of wireless LAN connection.
UPDATE	Reflect settings when they are changed.

## ⑩ Projecting Your Computer's Screen Image from the Projector via a Network [NETWORK PROJECTOR] (MM Models)

By selecting the projector connected to the same network as that of your PC, the PC screen image can be projected to the screen via network. There is no need of connection using the computer cable (VGA).

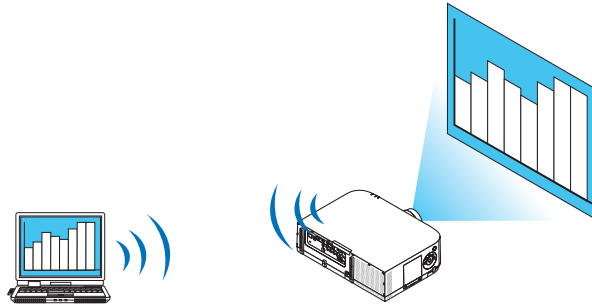

### Operation Environment

Applicable OS	Windows 8 Pro Windows 8 Enterprise Windows 7 Professional Windows 7 Ultimate Windows 7 Enterprise Windows Vista Home Premium Windows Vista Business Windows Vista Ultimate Windows Vista Enterprise
Hardware specifications	The specifications recommended by Microsoft as the operation environment for Windows 8/Windows 7/Windows Vista should be satisfied.
Network Environment	Wired LAN or wireless LAN environment that supports TCP/IP is required.
Screen color	High Color (16 bits) True Color (24 bits and 32 bits) * Setting with 256 colors or less is not available.

### Setting the Projector to Network Projector Input Mode

1. Press the "8/Ethernet" button on the remote control with the power supply to the projector turned on.

The application menu screen will be displayed.



### 3. Convenient Features

- When operating with the main body, press briefly the "INPUT" button to display the [INPUT TERMINAL] screen of the on-screen menu.

Press the ▼ button to select [8:ETHERNET] and then press the "ENTER" button to display the application menu screen.

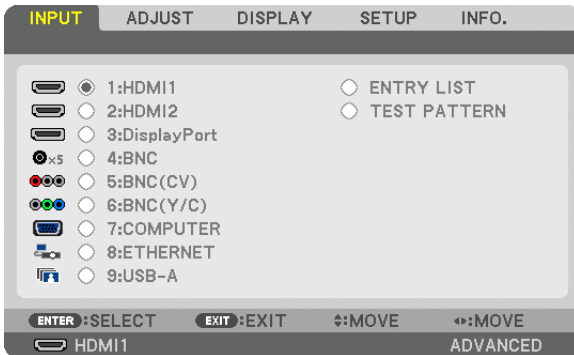

2. Press the SELECT ▼ or ▲ button to select [NETWORK] and press the ENTER button.

In the screen, the [APPLICATION MENU] menu is displayed.



3. From the [APPLICATION MENU] menu, select [NETWORK PROJECTOR].

The [PROJECTOR NAME/DISPLAY RESOLUTION/PASSWORD/URL] will be displayed.



#### Projecting the Image with Network Projector

1. Click [Start] from the desktop of Windows 7.
2. Click [All Programs].
3. Click [Accessories].
4. Click [Connect to a Network Projector].

When the [Permission Connect to a Network Projector] window appears, click [Yes].

The "Connect to a Network Projector" window appears.

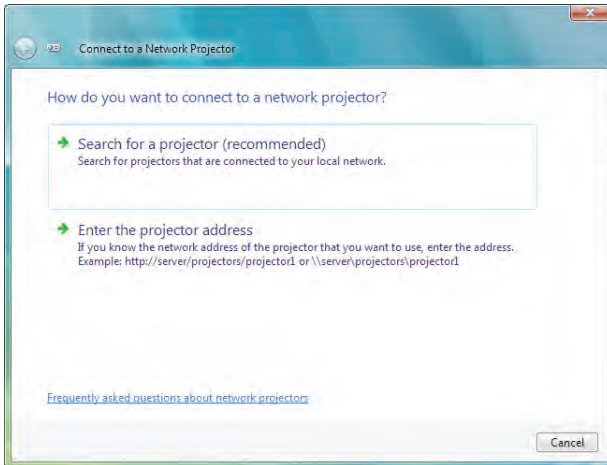

5. Click [→ Search for a projector (recommended)].

In the "Available projectors" box, "PA621U Series" is displayed.

6. Click [PA621U Series].

The message "Enter the password for the projector that you selected." is displayed at the bottom of the window.

7. Input the password to the password input box displayed by the operation at step 3 on page 55.

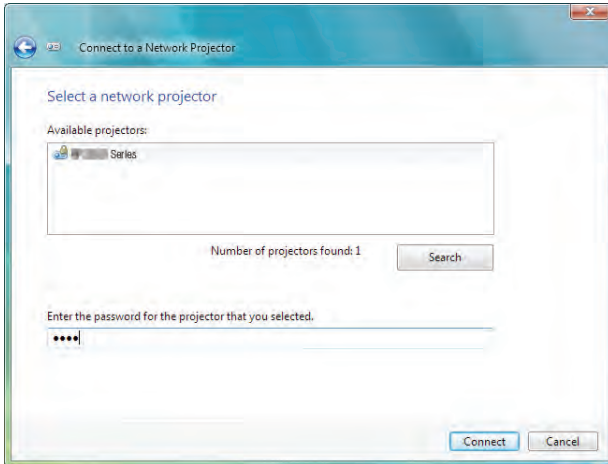

8. Click [Connect].

The network projector function works and the screen of Windows 7 is projected from the projector.

- If the resolution of your computer's screen is different from the projector's screen resolution, the NETWORK PROJECTOR function may not work. If this happens, change the resolution of the computer's screen to lower resolution than the one displayed at Step 3 on page 55.

---

*NOTE: When the network projector function works, the background color of the desktop changes to solid color. When the network projector function is stopped, the original background color is restored.*

---

*Reference: If the projector cannot be found at Step 5, click [ → Enter the projector address]. Then, input the "Network address" (Input example: `http://10.32.97.61/lan`) and "Projectorpassword" (Input example: `82291627`) displayed in the screen projected from the projector.*

---

## ① Using the Projector to Operate Your Computer via a Network [REMOTE DESKTOP] (MM Models)

- By selecting the PC connected to the same network as that of the projector, the PC screen image can be projected to the screen via network.  
Then, by operating the keyboard, you can operate Windows 8, Windows 7, Windows Vista or Windows XP on the PC connected with the network.
- With the Remote Desktop function, you can remotely operate the PC placed at a distance from the projector.

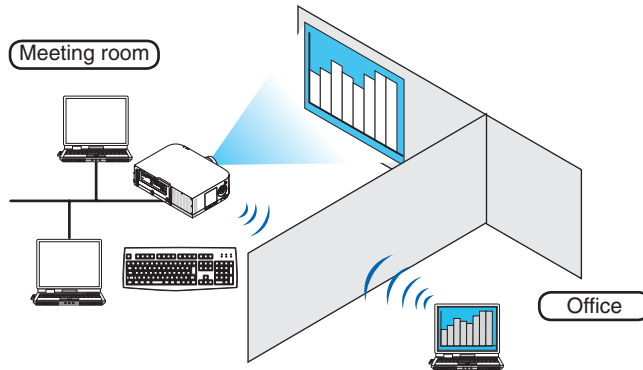

### NOTE:

- The [REMOTE DESKTOP] function will work on the following Windows editions.  
Windows 8 Pro, Windows 8 Enterprise,  
Windows 7 Professional, Windows 7 Ultimate, Windows 7 Enterprise,  
Windows Vista Home Premium, Windows Vista Business, Windows Vista Ultimate, Windows Vista Enterprise,  
Windows XP Professional with Service Pack 3
- In this user's manual this feature is described using Windows 7 as an example.
- A keyboard is required to use the Remote Desktop function.
- The Remote Desktop function can be operated with a keyboard. Using a wireless mouse with a wireless keyboard is more useful for operating.  
Use a commercially available wireless keyboard, a wireless mouse, and a USB wireless receiver.  
Use a commercially available USB keyboard and USB mouse.
- A USB keyboard with a built-in USB hub cannot be used with the projector.
- A wireless keyboard or mouse that supports Bluetooth cannot be used with the projector.
- We do not warrant that the USB port of the projector will support all USB devices in the market.

### Prepare a commercially available wireless keyboard (US layout version).

Connect the USB wireless receiver to the USB port (Type A) of the projector. Make all necessary settings for your wireless keyboard and mouse.

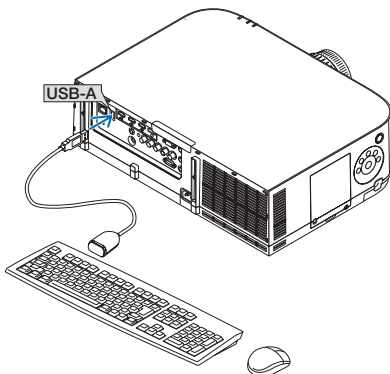



#### Setting the password to the user account of Windows 7

*TIP: If a password has been set for an account, the steps 1 to 9 can be skipped.*

1. Click [Start] from the desktop of Windows 7.
2. Click [Control Panel].
3. Click [Add or remove user accounts] displayed under [User Accounts].
4. When the [User Account Control] confirmation window appears, click [Continue].
5. Click [Administrator].
6. Click [Create a password].
7. Input the password to the [New password] box.
8. Input the same password as that at Step 7 to the [Confirm new password] box.
9. Click [Create a password].

The Administrator is changed to [Password Protection].

#### Setting the Remote Access

1. Click [Start] from the desktop of Windows 7.
2. Click [Control Panel].
3. Click [System and Security].
4. Click [Allow remote access] displayed under [System].
5. When the [User Account Control] confirmation window appears, click [Continue].  
The [System Properties] window appears.
6. Click [Allow connections from computers running any version of Remote Desktop (less secure)] in the Remote Desktop box and click [OK].

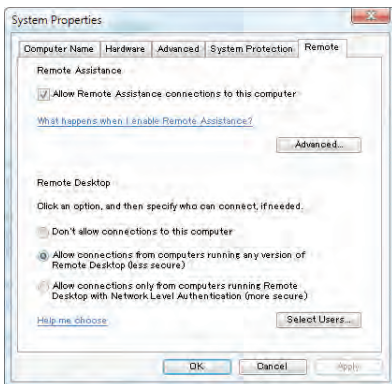

#### Checking the IP address on Windows 7

1. Click [Start] from the desktop of Windows 7.
2. Click [Control Panel].
3. Click [View network status and tasks] displayed under [Network and Internet].

- Click **[View status]** displayed in blue on the right of **[Local Area Connection]** in the window.  
The **[Local Area Connection Status]** window appears.

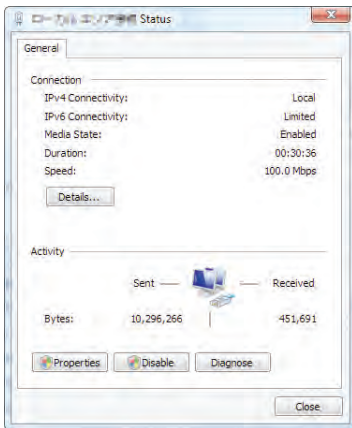

- Click **[Details...]**.  
Write down the value for "IPv4 IP Address" (xxx.xxx.xxx.xxx) displayed.

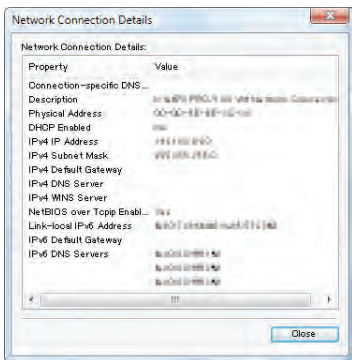

- Click **[Close]**.
- Click **[X]** at the upper right of the window.  
The system goes back to the desktop.

### Starting the Remote Desktop

- Press the "8/Ethernet" button on the remote control with the power supply to the projector turned on.  
The application menu screen will be displayed.



### 3. Convenient Features

- When operating with the main body, press briefly the “INPUT” button to display the [INPUT TERMINAL] screen of the on-screen menu.

Press the ▼ button to select [8:ETHERNET] and then press the “ENTER” button to display the application menu screen.

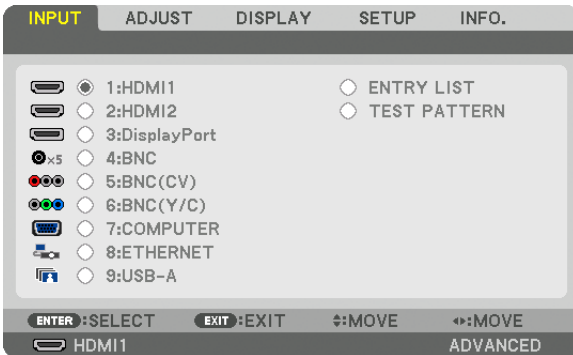

The [REMOTE DESKTOP CONNECTION] window appears.

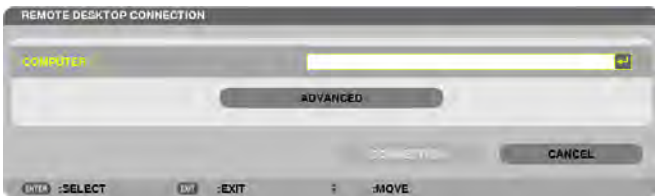

- Operate the wireless keyboard to input the IP address of Windows 7 and click [CONNECTION].

The log-on screen of Windows 7 is displayed in the screen projected by the projector.

- Operate the wireless keyboard to input the user’s password and press “Enter”.

The remote desktop function is started.

Windows 7 desktop is displayed in the screen projected by the projector.

Log out the computer.

Use the wireless keyboard connected to the projector to operate Windows 7.

---

**NOTE:** When the projection is made with the remote desktop function, the background color of the desktop is changed to solid color.

---

#### Exiting the Remote Desktop

1. Operate the wireless keyboard to click [Start] from the desktop screen projected by the projector.

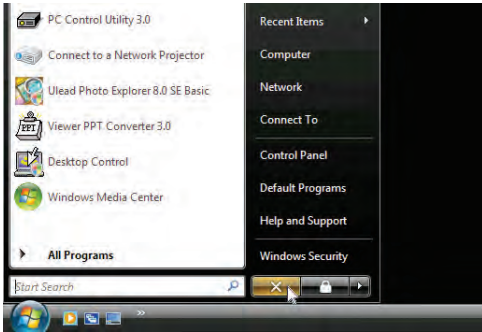

2. Click [X] on the right of the start menu.

The remote desktop function is stopped.

3. Press the button for an input terminal other than “8/Ethernet” on the remote control.

Switch the input terminal using the “INPUT” button for operations on the main body.

TIP:

Setting [OPTIONS] in REMOTE DESKTOP

Clicking [OPTIONS] displays the [PERFORMANCE] screen.

Making settings to [OPTIONS] will allow you to display the desktop background, or to enable the window animation function during the Remote Desktop operation. However, doing this will cause the display's or mouse's response to slow down.

If the display's or mouse's response is slowed down, try one or more of the following:

DESKTOP BACKGROUND: Clear the check mark to display the desktop background in solid color.

MENU AND WINDOW ANIMATION: Clear the check mark to disable menu and window animation.

THEMES: Clear the check mark not to use Themes.

SHOW CONTENTS OF WINDOW WHILE DRAGGING: Clear the check mark to show only the window pane while dragging.

# 4. Multi-Screen Projection

## ① Things that can be done using multi-screen projection

This projector can be used singly or arranged in multiple units for multi-screen projection. We will introduce an example using two projection screens here.

### Case 1

Using a single projector to project two types of videos at the same time [PIP/PICTURE BY PICTURE]

### Case 2

Using four projectors (liquid crystal panel: XGA) to project video with a resolution of 1920 × 1080 pixels [TILING]

### Case 1. Using a single projector to project two types of videos [PIP/PICTURE BY PICTURE]

Connection example and projection image

*In the case of [PICTURE BY PICTURE]*

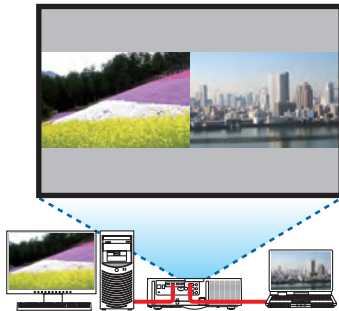

*In the case of [PIP]*

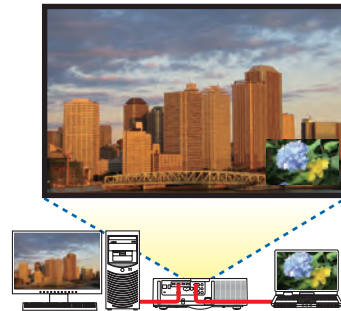

### On-screen menu operations

Display [DISPLAY] → [PIP/PICTURE BY PICTURE] → [MODE] screen in the on-screen menu and select [PIP] or [PICTURE BY PICTURE].

For details, please refer to “4-2 Displaying Two Pictures at the Same Time”. (→ page 67)

### Case 2. Using four projectors (liquid crystal panel: XGA) to project videos with a resolution of 1920 × 1080 pixels [TILING]

Connection example and projection image

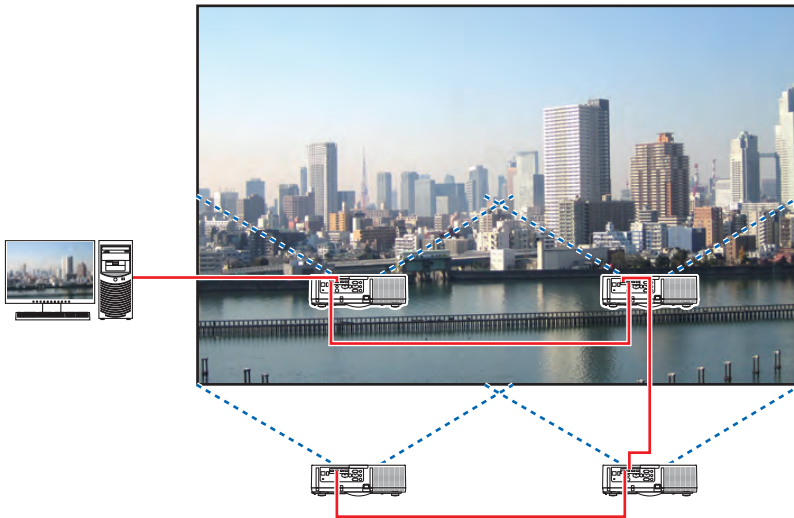

#### On-screen menu operations

##### 1 Four similar videos are displayed when four projectors are projected.

Please request the retail store to adjust the projection position of each projector.



#### NOTE:

- When setting up the projector, assign a unique control ID to each projector.
- Set the "Color setting" and "DeepColor setting" on your Blu-ray player or computer to "Auto". Refer to the owner's manual accompanied with your Blu-ray player or computer for more information.
- Connect an HDMI output of your Blu-ray player or computer to the first projector and then connect to the HDMI1 or HDMI2 input connector of the second and subsequent projectors.
- Selecting another input source on the second and subsequent projectors will disable the HDMI repeater function.

## 4. Multi-Screen Projection

### 2 Operate the on-screen menu using the four respective projectors to divide the image into four portions.

Display [DISPLAY] → [MULTI SCREEN] → [PICTURE SETTING] Screen in the on-screen menu and select [TILING].

(1) In the screen for setting the number of horizontal units, select [2 UNITS]. (number of units in the horizontal direction)

(2) In the screen for setting the number of vertical units, select [2 UNITS]. (number of units in the vertical direction)

(3) In the screen for setting the horizontal order, select [1st UNIT] or [2nd UNIT].

(look at the screens, the one on the left is the [1st UNIT] while the one on the right is the [2nd UNIT])

(4) In the screen for setting the vertical order, select the [1st UNIT] or the [2nd UNIT].

(look at the screens, the one at the top is the [1st UNIT] while the one at the bottom is the [2nd UNIT])



### 3 Adjust the lens shift of each projector to fine-tune the boundaries of the screen.

For further fine-tuning, adjust using [DISPLAY] → [EDGE BLENDING] in the on-screen menu for each projector.

For details, please refer to “4-3 Displaying a Picture Using [EDGE BLENDING]”.

(→ page 71)

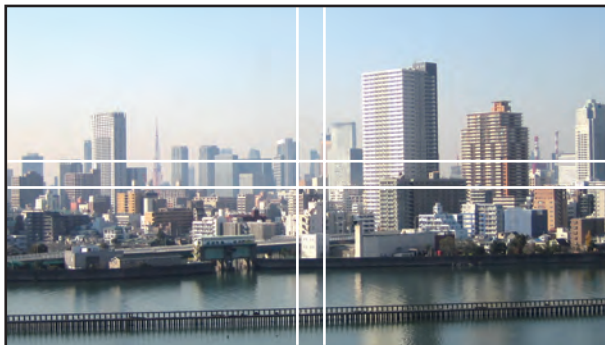

### Things to note when installing projectors

- Leave sufficient space on the left and right of the projector so that the intake and exhaust vents of the projector are not obstructed. When the intake and exhaust vents are obstructed, the temperature inside the projector will rise and this may result in a malfunction.

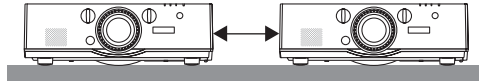

- Please do not pile up the projectors directly on top of one another when installing them. When the projectors are piled up on top of one another, they may fall down, resulting in damage and failure.

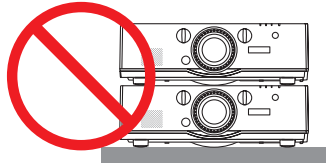

- Installation example when using two projectors

The following installation is recommended when combining the installation of two projectors for multi-screen projection. Please leave a space of at least 10 cm between the the intake/exhaust vent and the wall.

[Installation example]

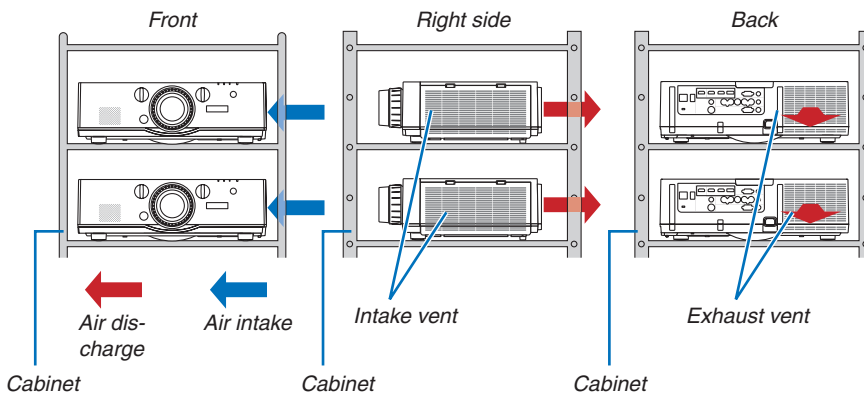

### WARNING

Please request the retail store for special installation services such as when mounting the projector to the ceiling. Never carry out the installation by yourself. The projector may fall down and result in injury. Please use a sturdy cabinet that can withstand the weight of the projector for the installation. Please do not pile up the projectors directly on top of one another.

### NOTE:

- For the range of the projection distance, please refer to the Appendix "Throw distance and screen size". (→ page 253)



## ② Displaying Two Pictures at the Same Time

The projector has a feature that allows you to view two different signals simultaneously. You have two modes: PIP mode and PICTURE BY PICTURE mode.

The projection video in the first screen display is known as the main display while the projection video that is called out subsequently is known as the sub-display.

Select the projection function under [DISPLAY] → [PIP/PICTURE BY PICTURE] → [MODE] in the on-screen menu (the default factory setting when shipped is PIP). (→ page 100)

- A single screen is projected when power is turned on.

### Picture in Picture function

A small sub-display is displayed inside the main display.

The sub-display can be set up and adjusted as follows. (→ page 100)

- Select whether to display the sub-display at the top right, top left, bottom right or bottom left of the screen (the size of the sub-display can be selected and the position can be fine-tuned)
- Switch the main display with the sub-display

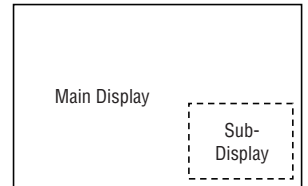

### Picture by picture function

Display the main display and sub-display side by side.

The main display and sub-display can be set up and adjusted as follows. (→ page 101)

- Selecting the display boundary (ratio) of the main display and sub-display
- Switch the main display and sub-display

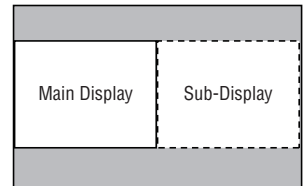

### Input terminals that can be used for the main screen and sub-screen.

The main screen and sub-screen can provide the following input terminals.

- The main display and sub-display support computer signals up to WUXGA@60HzRB.

		Sub-Display or additional display							HDBaseT
		HDMI1	HDMI2	DisplayPort	BNC	BNC(CV)	BNC(Y/C)	COMPUTER	
Main Display	HDMI1	No			Yes	Yes	Yes	Yes	No
	HDMI2				Yes	Yes	Yes	Yes	
	DisplayPort				Yes	Yes	Yes	Yes	
	BNC	Yes	Yes	Yes	No			No	Yes
	BNC(CV)	Yes	Yes	Yes				Yes	Yes
	BNC(Y/C)	Yes	Yes	Yes				Yes	Yes
	COMPUTER	Yes	Yes	Yes	No	Yes	Yes	No	Yes
	HDBaseT	No			Yes	Yes	Yes	Yes	No

**NOTE:**

- Some signals may not appear depending on the resolution.

### Projecting two screens

1. Press the **MENU** button to display the on-screen menu and select **[DISPLAY]** → **[PIP/PICTURE BY PICTURE]**.

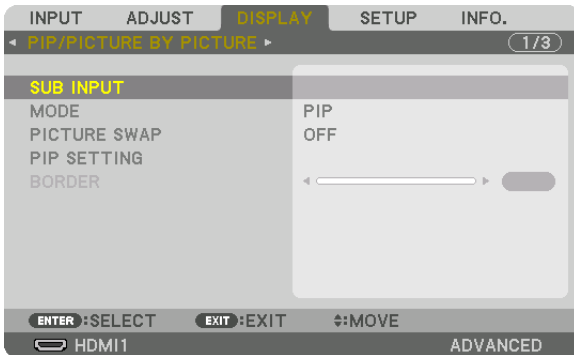

This displays the **[PIP/PICTURE BY PICTURE]** screen in the on-screen menu.

2. Select **[SUB INPUT]** using the **▼/▲** buttons, and press the **ENTER** button.

This displays the **[SUB INPUT]** screen.

3. Select the input signal using the **▼/▲** buttons, and press the **ENTER** button.

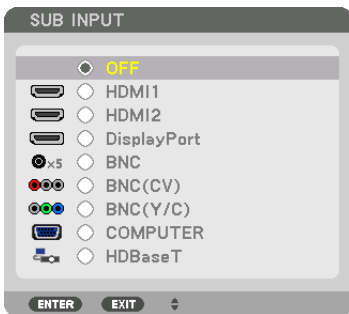

\* This screen belongs to a HDBaseT model.

The **[PIP]** (PICTURE IN PICTURE) or **[PICTURE BY PICTURE]** screen set up under **[MODE]** is projected. (→ page 100)

- When the signal name is displayed in grey, this means that it cannot be selected.
- The signal can also be selected by pressing the **PIP** button or **PBP/POP** button on the remote control.

4. Press the **MENU** button.

The on-screen menu will disappear.

5. When returning to single screen, display the **[PIP/PICTURE BY PICTURE]** screen one more time and select **[OFF]** in the **[SUB INPUT]** screen of the Step 3.

#### TIP:

- During dual-screen projection, if the selected input is not supported by the sub-screen, the sub-screen will appear as a black screen.

### Switching the main display with the sub-display and vice versa

1. Press the **MENU** button to display the on-screen menu and select **[DISPLAY]** → **[PIP/PICTURE BY PICTURE]**.

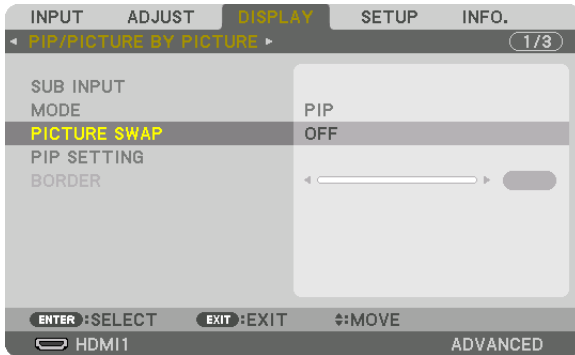

This displays the **[PIP/PICTURE BY PICTURE]** screen in the on-screen menu.

2. Select **[PICTURE SWAP]** using the **▼/▲** buttons and then press the **ENTER** button.  
Display the screen for switching the display positions.
3. Select **[ON]** using the **▼** button and then press the **ENTER** button.



The video of the main display will switch with that of the sub-display.

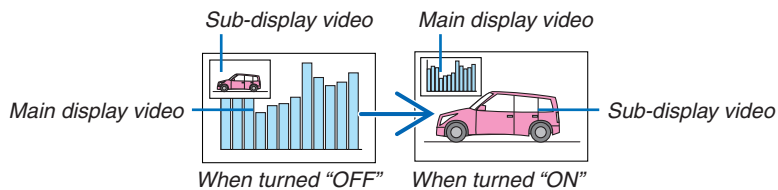

The signal output from the HDMI output terminal does not change even if the display positions are switched.

4. Press the **menu** button.

The on-screen menu will disappear.

### Restrictions

- The following operations are enabled only for the main display.
  - Audio-visual adjustments
  - Video magnification / compression using the partial D-ZOOM/ZOOM +/- buttons.  
However, magnification / compression is up to the positions set in [PICTURE BY PICTURE BORDER] only.
  - TEST PATTERN
- The following operations are enabled for both the main display and sub-display. These operations cannot be applied individually.
  - Momentary deletion of video / audio
  - Video pause
- [PIP/PICTURE BY PICTURE] cannot be used when a 3D video is being displayed.
- When using the [PIP/PICTURE BY PICTURE] function, [CLOSED CAPTION] and [DYNAMIC CONTRAST] can be used.
- [PIP/PICTURE BY PICTURE] cannot be used when the signal input has a resolution of 1920 × 1200 or more.
- The HDMI output terminal has a repeater function. The output resolution is limited by the maximum resolution of the connected monitor and projector.

### ③ Displaying a Picture Using [EDGE BLENDING]

A high resolution video can be projected on an even bigger screen by combining multiple projectors on the left, right, top and bottom.

This projector is equipped with an “EDGE BLENDING Function” that makes the edges (boundaries) of the projection screen indistinguishable.

**NOTE:**

- For projector throw distances, refer to “Throw distance and screen size” on page 253.
- Before performing the Edge Blending function, place the projector in the correct position so that the image becomes square in the appropriate size, and then make optical adjustments (lens shift, focus, and zoom).
- Adjust the brightness of each projector using [LAMP ADJUST] under [LAMP MODE]. In addition, use [REF. WHITE BALANCE] to adjust the [CONTRAST], [BRIGHTNESS] and [UNIFORMITY].

#### Before explaining use of the Edge Blending function

This section explains the case for “Example: Placing two projectors side by side”. As shown, the projected image on the left is referred to as “Projector A” and the projected image on the right is referred to “Projector B”. Unless otherwise specified hereinafter, the “projector” is used to mean both A and B.

#### Example: Placing two projectors side by side

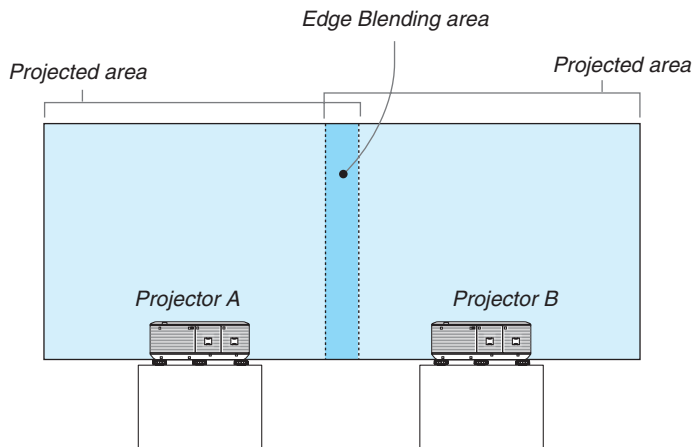

### Preparation:

- Turn on the projector and display a signal.
- When performing settings or adjustments using the remote control, enable the [CONTROL ID] so as not to activate the other projectors. (→ page 120)

### Setting the overlap of projection screens

#### ① Enable [EDGE BLENDING].

##### 1 Press the “Edge Blend.” button.

The [EDGE BLENDING] screen will be displayed. Align the cursor with [MODE] and then press the ENTER button. The mode screen will be displayed.

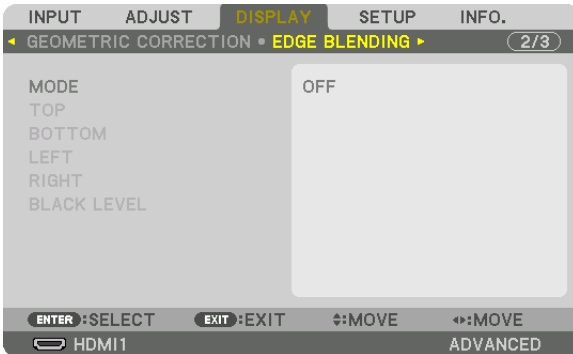

##### 2 Select [MODE] → [ON] and press the ENTER button.

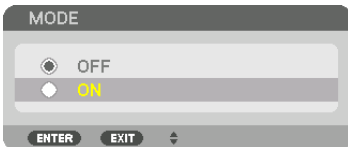

This enables the Edge Blending function. The following menu items are available: [TOP], [BOTTOM], [LEFT], [RIGHT], and [BLACK LEVEL]

##### 3 Select [RIGHT] for Projector A and [LEFT] for Projector B.

Press the ENTER button.



The following items are available:

[CONTROL], [MARKER], [RANGE], and [POSITION]

### 4 Select [CONTROL] → [ON] and press the ENTER button.

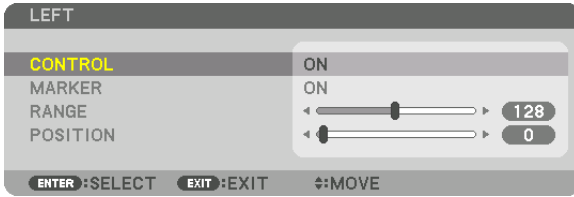

Each [TOP], [BOTTOM], [LEFT], [RIGHT], and [BLACK LEVEL] has its own [CONTROL], [MARKER], [RANGE], and [POSITION].

- For Projector A, set the [CONTROL] for the [TOP], [LEFT] and [BOTTOM] to [OFF]. Similarly for Projector B, set the [CONTROL] for the [TOP], [RIGHT] and [BOTTOM] to [OFF].

### ② Adjust [RANGE] and [POSITION] to determine an area of overlapped edges of images projected from each projector.

Turning on [MARKER] will display markers in magenta and green.  
The magenta marker is used for [RANGE] and green one for [POSITION].

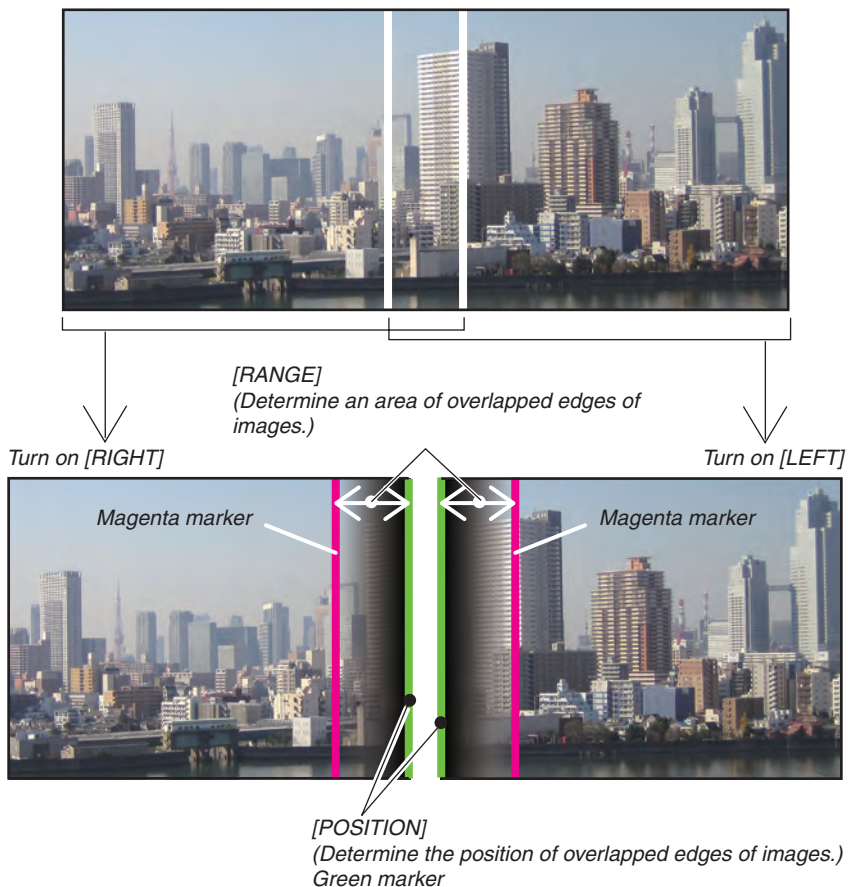

\* The 2 screens are separated in the diagram for explanatory purposes.

### 1 Adjust [RANGE].

Use the ◀ or ▶ button to adjust the overlapped area.

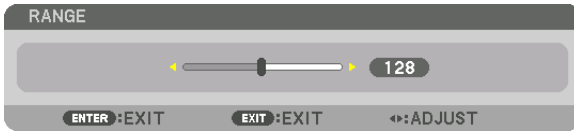

TIP:

- Adjust to overlap one projector's marker with the other projector's marker.

### 2 Adjust [POSITION].

Use the ◀ or ▶ button to align one edge with the other edge of overlapped images.

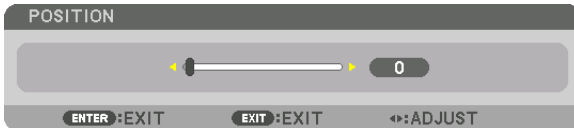

TIP:

- When displaying a signal with a different resolution, perform the Edge Blending function from the start.
- Setting of [MARKER] will not be saved and return to [OFF] when the projector is turned off.
- To display or hide the marker while the projector is running, turn on or off [MARKER] from the menu.



### Black Level Adjustment

This adjusts the black level of the overlapping area and the non-overlapping area of the multi-screen (EDGE BLENDING).

Adjust the brightness level if you feel the difference is too large.

**NOTE:**

This function is enabled only when [MODE] is turned on.

Adjustable area varies depending on what combination of [TOP], [BOTTOM], [LEFT] and [RIGHT] are turned on.

**Example: Adjusting the Black Level when placing two projectors side by side**

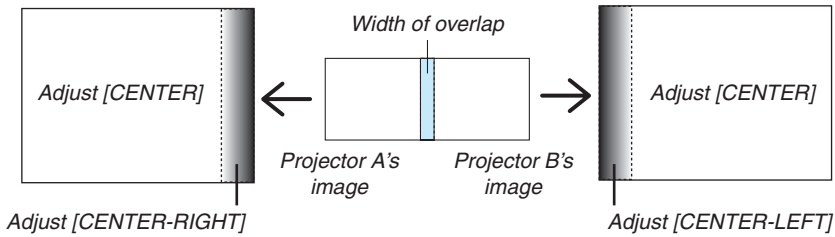

**1. Turn on [MODE]**

**2. Select [BLACK LEVEL] and press the ENTER button.**

The screen will switch to the black level adjustment screen.



**3. Use the ▼ or ▲ button to select an item and use the ◀ or ▶ to adjust the black level.**

Do this for the other projector if necessary.

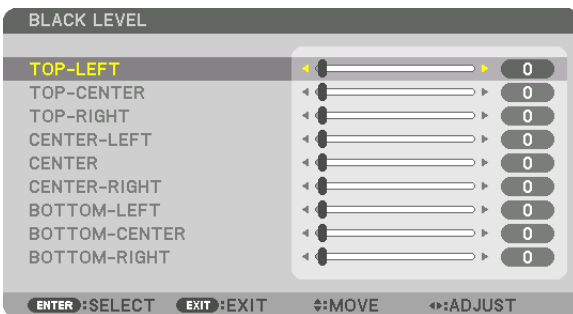

### 9-segmented portions for Black Level adjustment

The center projector

This function adjusts the brightness level of 9-segmented portions for the center projector and 4-segmented portions for the left bottom projector as shown below.

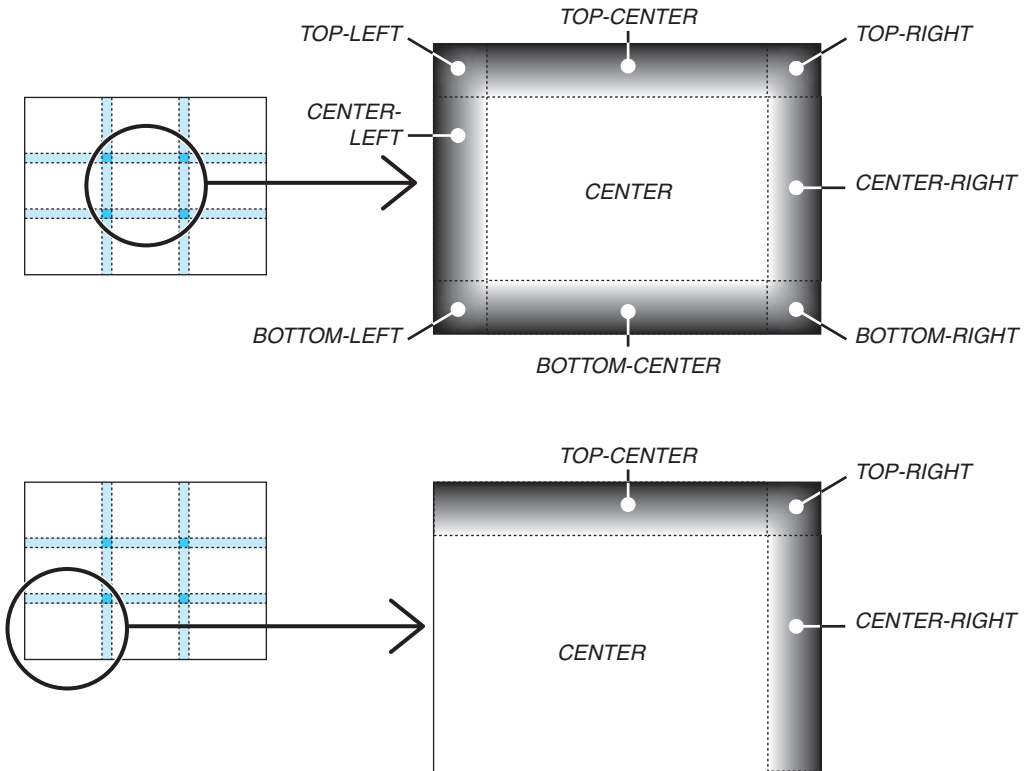

**TIP:**

- The number of black level division screens (maximum of nine divisions) changes depending on the number of edge blending positions selected (top, bottom, right, left). In addition, when the top / bottom and left / right ends are selected, the corner division screen appears.
- The edge blending width is the width set in the range and the corner is formed by the intersecting area of the top / bottom ends or left / right ends.
- The [BLACK LEVEL] can be adjusted to make it brighter only.

# 5. Using On-Screen Menu

## ① Using the Menus

*NOTE: The on-screen menu may not be displayed correctly while interlaced motion video image is projected.*

1. Press the **MENU** button on the remote control or the projector cabinet to display the menu.

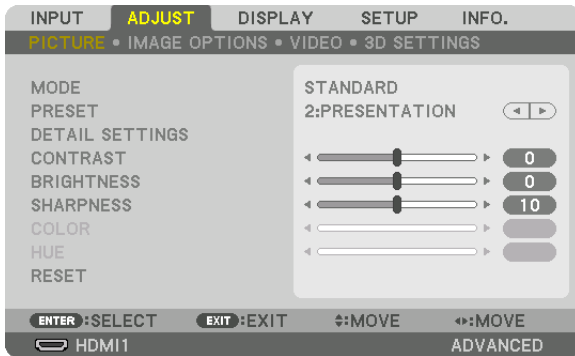

*NOTE: The commands such as ENTER, EXIT, ▲▼, ◀▶ in the bottom show available buttons for your operation.*

2. Press the ◀▶ buttons on the remote control or the projector cabinet to display the submenu.
3. Press the ENTER button on the remote control or the projector cabinet to highlight the top item or the first tab.
4. Use the ▲▼ buttons on the remote control or the projector cabinet to select the item you want to adjust or set.  
You can use the ◀▶ buttons on the remote control or the projector cabinet to select the tab you want.
5. Press the ENTER button on the remote control or the projector cabinet to display the submenu window.
6. Adjust the level or turn the selected item on or off by using the ▲▼◀▶ buttons on the remote control or the projector cabinet.  
Changes are stored until adjusted again.
7. Repeat steps 2-6 to adjust an additional item, or press the EXIT button on the remote control or the projector cabinet to quit the menu display.

*NOTE: When a menu or message is displayed, several lines of information may be lost, depending on the signal or settings.*

8. Press the **MENU** button to close the menu.  
To return to the previous menu, press the **EXIT** button.

## 2 Menu Elements

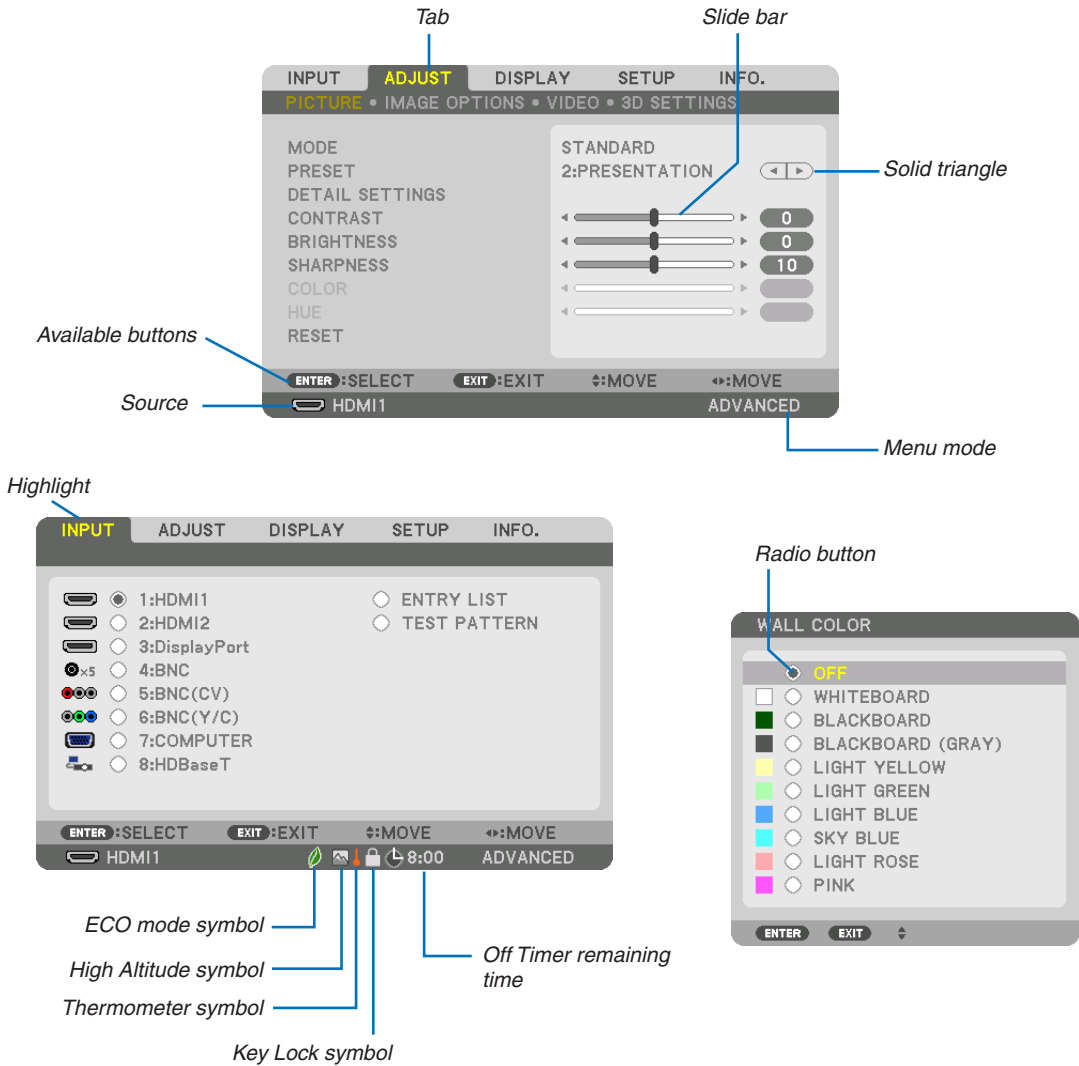

### Menu windows or dialog boxes typically have the following elements:

- Highlight ..... Indicates the selected menu or item.
- Solid triangle ..... Indicates further choices are available. A highlighted triangle indicates the item is active.
- Tab ..... Indicates a group of features in a dialog box. Selecting on any tab brings its page to the front.
- Radio button ..... Use this round button to select an option in a dialog box.
- Source ..... Indicates the currently selected source.
- Menu mode ..... Indicates the current menu mode: BASIC or ADVANCED.
- Off Timer remaining time .... Indicates the remaining countdown time when the [OFF TIMER] is preset.
- Slide bar ..... Indicates settings or the direction of adjustment.
- ECO mode symbol ..... Indicates [ECO MODE] is set.
- Key Lock symbol ..... Indicates the [CONTROL PANEL LOCK] is enabled.
- Thermometer symbol ..... Indicates the [ECO MODE] is forcibly set to [ON] mode because the internal temperature is too high.
- High Altitude symbol ..... Indicates the [FAN MODE] is set to [HIGH ALTITUDE] mode.

### 3 List of Menu Items

• Basic menu items are indicated by shaded area.

Some menu items are not available depending on the input source.

Menu Item	Default	Options		
INPUT	1:HDMI1	*		
	2:HDMI2	*		
	3:DisplayPort	*		
	4:BNC	*		
	5:BNC(CV)	*		
	6:BNC(Y/C)	*		
	7:COMPUTER	*		
	8:HDBaseT*1			
	8:ETHERNET*2			
	9:USB-A*2			
	ENTRY LIST			
TEST PATTERN				
ADJUST	MODE	STANDARD	STANDARD, PROFESSIONAL	
	PRESET	*	HIGH-BRIGHT, PRESENTATION, VIDEO, MOVIE, GRAPHIC, sRGB, DICOM SIM.	
	DETAIL SETTINGS	GENERAL		
		REFERENCE	*	HIGH-BRIGHT, PRESENTATION, VIDEO, MOVIE, GRAPHIC, sRGB, DICOM SIM.
		GAMMA CORRECTION*3		DYNAMIC, NATURAL, BLACK DETAIL
		SCREEN SIZE*4	*	LARGE, MEDIUM, SMALL
		COLOR TEMPERATURE*5	*	
		DYNAMIC CONTRAST	*	OFF, MOTION IMAGE, STILL IMAGE
		WHITE BALANCE		
		CONTRAST R	0	
		CONTRAST G	0	
		CONTRAST B	0	
		BRIGHTNESS R	0	
		BRIGHTNESS G	0	
		BRIGHTNESS B	0	
		COLOR CORRECTION		
	RED	0		
	GREEN	0		
	BLUE	0		
	YELLOW	0		
	MAGENTA	0		
	CYAN	0		
	CONTRAST	50		
	BRIGHTNESS	50		
	SHARPNESS	10		
	COLOR	50		
	HUE	0		
	RESET			
	IMAGE OPTIONS	CLOCK	*	
		PHASE	*	
		HORIZONTAL	*	
		VERTICAL	*	
		BLANKING	*	TOP, BOTTOM, LEFT, RIGHT
OVERSCAN		*	AUTO, 0[%], 5[%], 10[%]	
ASPECT RATIO		*	(COMPUTER) AUTO, 4:3, 5:4, 16:9, 15:9, 16:10, NATIVE	
		*	(COMPONENT/VIDEO/S-VIDEO) AUTO, 4:3, LETTERBOX, WIDE SCREEN, ZOOM	
INPUT RESOLUTION*6	*	(COMPONENT/VIDEO/S-VIDEO) AUTO, 4:3 WINDOW, LETTERBOX, WIDE SCREEN, FULL		
VIDEO	NOISE REDUCTION	RANDOM NR	*	OFF, LOW, MEDIUM, HIGH
		MOSQUITO NR	OFF	OFF, LOW, MEDIUM, HIGH
		BLOCK NR	OFF	OFF, LOW
	DEINTERLACE		NORMAL	NORMAL, MOVIE, STILL
	CONTRAST ENHANCEMENT	MODE	AUTO	OFF, AUTO, NORMAL
	SIGNAL TYPE		AUTO	AUTO, RGB, COMPONENT
	VIDEO LEVEL		AUTO	AUTO, NORMAL, ENHANCED

\* The asterisk (\*) indicates that the default setting varies depending on the signal.

\*1 Only HDBaseT models will be displayed.

\*2 Only MM models will be displayed.

\*3 The [GAMMA CORRECTION] item is available when an item other than [DICOM SIM.] is selected for [REFERENCE].

\*4 The [SCREEN SIZE] item is available when [DICOM SIM.] is selected for [REFERENCE].

\*5 When [PRESENTATION] or [HIGH-BRIGHT] is selected in [REFERENCE], the [COLOR TEMPERATURE] is not available.

\*6 The [INPUT RESOLUTION] item can be selected for COMPUTER input and BNC (analog RGB) input.

## 5. Using On-Screen Menu

Menu Item		Default	Options	
ADJUST	3D SETTINGS	STEREO VIEWER	SINGLE	
		STEREO FILTER	SINGLE	
		FORMAT	AUTO	
		L/R INVERT	OFF	
DISPLAY	PIP/PICTURE BY PICTURE	SUB INPUT	OFF, HDMI1, HDMI2, DisplayPort, BNC, BNC(CV), BNC(Y/C), COMPUTER, HDBaseT*7	
		MODE	PIP, PICTURE BY PICTURE	
		PICTURE SWAP	OFF	
		PIP SETTING	START POSITION	TOP-LEFT, TOP-RIGHT, BOTTOM-LEFT, BOTTOM-RIGHT
			HORIZONTAL POSITION	
			VERTICAL POSITION	
	SIZE		LARGE, MEDIUM, SMALL	
	BORDER			
	GEOMETRIC CORRECTION	KEYSTONE	HORIZONTAL	
			VERTICAL	
			TILT	
			THROW RATIO	
		CORNERSTONE	TOP-LEFT, TOP, TOP-RIGHT, LEFT, RIGHT, BOTTOM-LEFT, BOTTOM, BOTTOM-RIGHT	
		HORIZONTAL CORNER	TOP-LEFT, TOP, TOP-RIGHT, LEFT, RIGHT, BOTTOM-LEFT, BOTTOM, BOTTOM-RIGHT	
		VERTICAL CORNER	TOP-LEFT, TOP, TOP-RIGHT, LEFT, RIGHT, BOTTOM-LEFT, BOTTOM, BOTTOM-RIGHT	
PINCUSHION	TOP, BOTTOM, LEFT, RIGHT			
PC TOOL	OFF			
RESET	OFF, 1, 2, 3			
EDGE BLENDING	TOP	MODE	OFF	
		CONTROL	ON	
		MARKER	ON	
		RANGE	OFF, ON	
	BOTTOM	CONTROL	ON	
		MARKER	ON	
		RANGE	OFF, ON	
		POSITION		
	LEFT	CONTROL	ON	
		MARKER	ON	
		RANGE	OFF, ON	
		POSITION		
	RIGHT	CONTROL	ON	
		MARKER	ON	
		RANGE	OFF, ON	
		POSITION		
	BLACK LEVEL	TOP-LEFT		
		TOP-CENTER		
		TOP-RIGHT		
		CENTER-LEFT		
CENTER				
CENTER-RIGHT				
BOTTOM-LEFT				
BOTTOM-CENTER				
BOTTOM-RIGHT				
MULTI SCREEN	WHITE BALANCE	MODE	OFF	
		CONTRAST W		
		CONTRAST R		
		CONTRAST G		
		CONTRAST B		
		BRIGHTNESS W		
		BRIGHTNESS R		
		BRIGHTNESS G		
		BRIGHTNESS B		
		PICTURE SETTING	ZOOM	MODE
HORIZONTAL ZOOM	OFF, ZOOM, TILING			
VERTICAL ZOOM				
HORIZONTAL POSITION				
TILING	VERTICAL POSITION			
	WIDTH		1 UNIT, 2 UNITS, 3 UNITS, 4 UNITS	
	HEIGHT		1 UNIT, 2 UNITS, 3 UNITS, 4 UNITS	
	HORIZONTAL POSITION		1st UNIT, 2nd UNIT, 3rd UNIT, 4th UNIT	
VERTICAL POSITION	1st UNIT, 2nd UNIT, 3rd UNIT, 4th UNIT			

\*7 [ETHERNET] will be displayed for MM models.



## 5. Using On-Screen Menu

Menu Item		Default	Options					
SETUP	CONTROL	TOOLS	ADMINISTRATOR MODE	MENU MODE ADVANCED	ADVANCED, BASIC			
			NOT SAVE SETTING VALUES	OFF	OFF, ON			
			NEW PASSWORD					
			CONFIRM PASSWORD					
			PROGRAM TIMER	SETTINGS	ENABLE	OFF	OFF, ON	
					EDIT	ACTIVE		OFF, ON
						DAY		SUN, MON, TUE, WED, THU, FRI, SAT, MON-FRI, MON-SAT, EVERY DAY
						TIME		
						FUNCTION		POWER, INPUT, ECO MODE
						ADVANCED SETTINGS		
						POWER		OFF, ON
						INPUT		HDMI1, HDMI2, DisplayPort, BNC, BNC(CV), BNC(Y/C), COMPUTER, HDBaseT
						ECO MODE		OFF, ON
					REPEAT		OFF, ON	
					DELETE UP			
					DOWN			
					BACK			
			DATE AND TIME SETTINGS	TIME ZONE SETTINGS	GMT		-12:00, -11:30, -11:00, -10:30, -10:00, -09:30, -09:00, -08:30, -08:00, -07:30, -07:00, -06:30, -06:00, -05:30, -05:00, -04:30, -04:00, -03:30, -03:00, -02:30, -02:00, -01:30, -01:00, -00:30, 00:00, +00:30, +01:00, +01:30, +02:00, +02:30, +03:00, +03:30, +04:00, +04:30, +05:00, +05:30, +06:00, +06:30, +07:00, +07:30, +08:00, +08:30, +09:00, +09:30, +10:00, +10:30, +11:00, +11:30, +12:00, +12:30, +13:00	
						DATE MM/DD/YYYY		
				DATE AND TIME SETTINGS	TIME HH:MM			
					INTERNET TIME SERVER		OFF, ON	
					IP ADDRESS			
					UPDATE			
				SUMMER TIME SETTINGS	ENABLE		OFF, ON	
					MON(START)		1, 2, 3, 4, 5, 6, 7, 8, 9, 10, 11, 12	
					DAY(START)		FIRST WEEK, SECOND WEEK, THIRD WEEK, FOURTH WEEK, LAST WEEK	
							SUN, MON, TUE, WED, THU, FRI, SAT	
					TIME(START)			
					MON(EXIT)		1, 2, 3, 4, 5, 6, 7, 8, 9, 10, 11, 12	
					DAY(EXIT)		FIRST WEEK, SECOND WEEK, THIRD WEEK, FOURTH WEEK, LAST WEEK	
				SUN, MON, TUE, WED, THU, FRI, SAT				
			TIME(EXIT)					
			TIME DIFFERENCE		+01:00, +00:30, -00:30, -01:00			
			MOUSE		(Note) Cannot be used for this device.			
			CONTROL PANEL LOCK		OFF	OFF, ON		
			SECURITY		OFF	OFF, ON		
			COMMUNICATION SPEED		38400bps	4800bps, 9600bps, 19200bps, 38400bps, 115200bps		
			CONTROL ID	CONTROL ID NUMBER	1	1-254		
				CONTROL ID	OFF	OFF, ON		
			REMOTE SENSOR		FRONT/ BACK	FRONT/BACK, FRONT, BACK, HDBase-T*8		
BEEP		ON	OFF, ON					

\*8 [HDBaseT] will not be displayed for MM models.



## 5. Using On-Screen Menu

Menu Item		Default	Options		
SETUP	NETWORK SETTINGS	PROFILES	DISABLE, PROFILE 1, PROFILE 2		
		DHCP	OFF, ON		
		IP ADDRESS	192.168.0.10		
		SUBNET MASK	255.255.255.0		
		GATEWAY	192.168.0.1		
		AUTO DNS	OFF, ON		
		DNS CONFIGURATION			
		RECONNECT			
		PROJECTOR NAME	PROJECTOR NAME	6762WUA Series*	
		HOST NAME		necpj	
		DOMAIN	DOMAIN NAME		
		ALERT MAIL	ALERT MAIL		OFF, ON
			HOST NAME		
			DOMAIN NAME		
			SENDER'S ADDRESS		
			SMTP SERVER NAME		
			RECIPIENT'S ADDRESS 1		
	RECIPIENT'S ADDRESS 2				
	RECIPIENT'S ADDRESS 3				
	TEST MAIL				
	NETWORK SERVICE	HTTP SERVER	NEW PASSWORD CONFIRM PASSWORD		
		PJLink	NEW PASSWORD CONFIRM PASSWORD		
		AMX BEACON		OFF, ON	
		CRE-STRON	ROOMVIEW		
		CRESTRON CONTROL			
	SOURCE OPTIONS	AUTO ADJUST	NORMAL	OFF, NORMAL, FINE	
		COLOR SYSTEM	BNC(VIDEO)	AUTO	AUTO, NTSC3.58, NTSC4.43, PAL, PAL-M, PAL-N, PAL60, SECAM
			BNC(Y/C)	AUTO	AUTO, NTSC3.58, NTSC4.43, PAL, PAL-M, PAL-N, PAL60, SECAM
		AUDIO SELECT	HDMI1	HDMI1	HDMI1, BNC
			HDMI2	HDMI2	HDMI2, BNC
			DisplayPort	DisplayPort	DisplayPort, BNC
			HDBaseT*10	HDBaseT	HDBaseT, BNC
			ETHERNET*11	ETHERNET	ETHERNET, BNC
		USB-A*11	USB-A	USB-A, BNC	
		DEFAULT INPUT SELECT	LAST	LAST, AUTO, HDMI1, HDMI2, DisplayPort, BNC, BNC(CV), BNC(Y/C), COMPUTER, HDBaseT*12	
SEAMLESS SWITCHING	OFF	OFF, ON			
CLOSED CAPTION	OFF	OFF, CAPTION1, CAPTION2, CAPTION3, CAPTION4, TEXT1, TEXT2, TEXT3, TEXT4			
BACKGROUND	BLUE	BLUE, BLACK, LOGO			
POWER OPTIONS	STANDBY MODE	NORMAL	NORMAL, HDBaseT STANDBY*13		
	DIRECT POWER ON	OFF	OFF, ON		
	AUTO POWER ON SELECT	OFF	OFF, HDMI1, HDMI2, DisplayPort, COMPUTER, HDBaseT*14		
	AUTO POWER OFF	1:00	OFF, 0:05, 0:10, 0:15, 0:20, 0:30, 1:00		
	OFF TIMER	OFF	OFF, 0:30, 1:00, 2:00, 4:00, 8:00, 12:00, 16:00		
RESET	CURRENT SIGNAL				
	ALL DATA				
	ALL DATA (INCLUDING ENTRY LIST)				
	CLEAR LAMP HOURS				
	CLEAR FILTER HOURS				

\*9 [6762WU Series] will be displayed for MM models.

\*10 Only HDBaseT models will be displayed.

\*11 Only MM models will be displayed.

\*12 [ETHERNET] will be displayed for MM models.

\*13 [NETWORK STANDBY] will be displayed for MM models.

\*14 [HDBaseT] will be displayed for HDBaseT models only.

## 5. Using On-Screen Menu

Menu Item		Default	Options
INFO.	USAGE TIME	LAMP LIFE REMAINING	
		LAMP HOURS USED	
		FILTER HOURS USED	
		TOTAL CARBON SAVINGS	
	SOURCE(1)	INPUT TERMINAL	
		RESOLUTION	
		HORIZONTAL FREQUENCY	
		VERTICAL FREQUENCY	
		SYNC TYPE	
		SYNC POLARITY	
		SCAN TYPE	
		SOURCE NAME	
	ENTRY NO.		
	SOURCE(2)	SIGNAL TYPE	
		VIDEO TYPE	
		BIT DEPTH	
		VIDEO LEVEL	
		LINK RATE	
		LINK LANE	
	SOURCE(3)	INPUT TERMINAL	
		RESOLUTION	
		HORIZONTAL FREQUENCY	
		SYNC TYPE	
		SOURCE NAME	
		ENTRY NO.	
	SOURCE(4)	SIGNAL TYPE	
		VIDEO TYPE	
		BIT DEPTH	
		VIDEO LEVEL	
		LINK RATE	
		LINK LANE	
	WIRED LAN	IP ADDRESS	
		SUBNET MASK	
		GATEWAY	
		MAC ADDRESS	
	VERSION(1)	FIRMWARE	
		DATA	
		SUB-CPU	
	VERSION(2)* <sup>15</sup>	FIRMWARE(MM)	
	OTHERS	DATE TIME	
		PROJECTOR NAME	
		MODEL NO.	
		SERIAL NUMBER	
		CONTROL ID* <sup>16</sup>	
	CONDITIONS	INTAKE TEMPERATURE	
		EXHAUST TEMPERATURE	
		INSTALLATION POSITION	
X-AXIS			
Y-AXIS			
HDBaseT* <sup>17</sup>	Z-AXIS		
	SIGNAL QUALITY		
	OPERATION MODE		
	LINK STATUS		
	HDMI STATUS		

\*15 Only MM models will be displayed.

\*16 [CONTROL ID] will be displayed when [CONTROL ID] has been set up.

\*17 Only HDBaseT models will be displayed.

## 4 Menu Descriptions & Functions [INPUT]

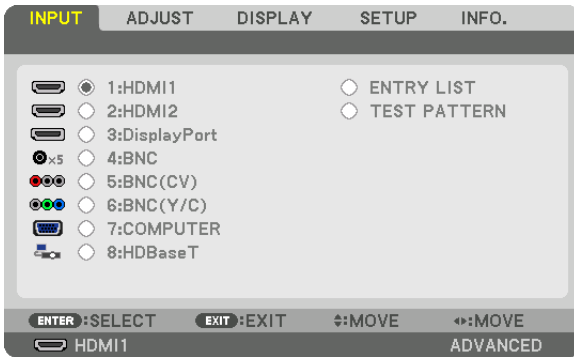

\* This screen belongs to a HDBaseT model.

### 1:HDMI1

This projects the video of the device connected to the HDMI 1 IN terminal.

### 2:HDMI2

This projects the video of the device connected to the HDMI 2 IN terminal.

### 3:DisplayPort

This projects the video of the device connected to the Display Port input terminal.

### 4:BNC

This projects the video of the device connected to the video input terminal.  
(This projects the analog RGB signal or component signal.)

### 5:BNC(CV)

This projects the video of the device connected to the BNC (CV) video input terminal.  
(This projects the composite video signal.)

### 6:BNC(Y/C)

This projects the video of the device connected to the BNC (Y/C) video input terminal.  
(This projects the S-video signal.)

### 7:COMPUTER

This projects the video of the device connected to the computer video input terminal.  
(This projects the analog RGB signal or component signal.)

### 8:HDBaseT\*1

Projecting the HDBaseT or WIRED LAN signal.

### 8:ETHERNET\*2

Switch to the data display that is sent from the network.

### 9:USB-A\*2

Switch to the data display (viewer display) of the USB memory that has been set up in the projector. (→ page 225)

### ENTRY LIST

Displays a list of signals. See the following pages.

### TEST PATTERN

Closes the menu and switches to the test pattern screen.

\*1 Only HDBaseT models will be displayed.

\*2 Only MM models will be displayed.

### Using the Entry List

When any source adjustments are made, the adjustments are automatically registered in the Entry List. The (adjustment values of) registered signals can be loaded from the Entry List whenever necessary.

However, only up to 100 patterns can be registered in the Entry List. When 100 patterns have been registered in the Entry List, an error message is then displayed and no additional patterns can be registered. You should thus delete (adjustment values of) signals that are no longer needed.

#### Displaying the Entry list

##### 1. Press the **MENU** button.

The menu will be displayed.

##### 2. Press the **◀** or **▶** button to select **[INPUT]**.

The **INPUT** list will be displayed.

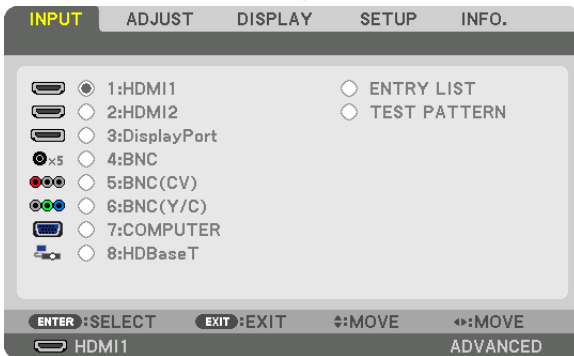

\* This screen belongs to a HDBaseT model.

##### 3. Use the **◀**, **▶**, **▲**, or **▼** to select **[ENTRY LIST]** and press the **ENTER** button.

The **ENTRY LIST** windows will be displayed.

If the **ENTRY LIST** window is not displayed, switch the menu to **[ADVANCED]**.

To switch the menu between **[ADVANCED]** and **[BASIC]**, select **[SETUP]** → **[CONTROL]** → **[TOOLS]** → **[ADMINISTRATOR MODE]** → **[MENU MODE]**. (→ page 114)

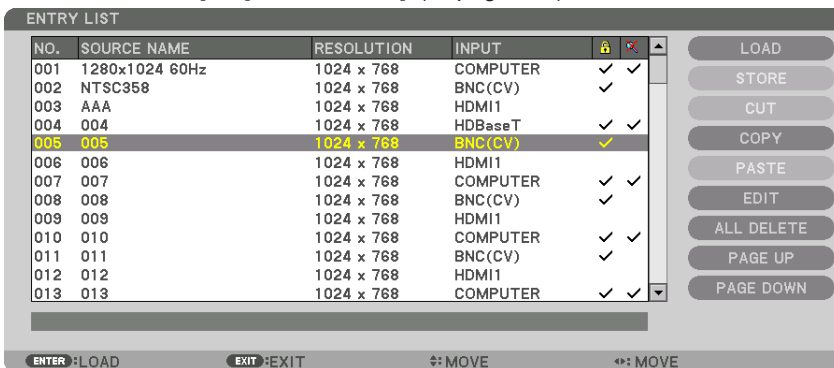

Entering the currently projected signal into the Entry List [STORE]

1. Press the ▲ or ▼ button to select any number.
2. Press the ◀ or ▶ button to select [STORE] and press the ENTER button.

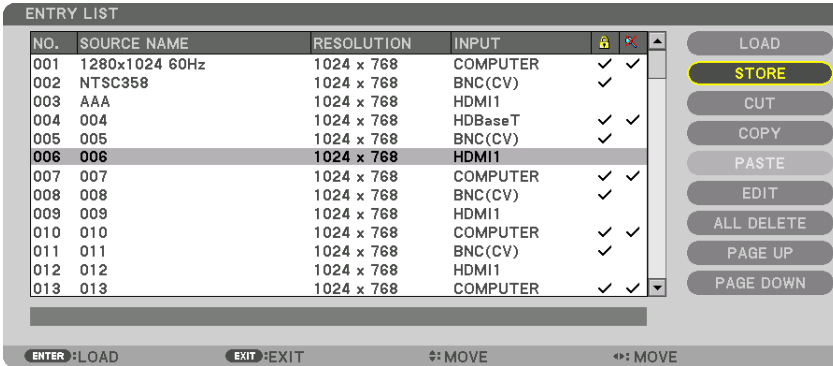

Calling up a signal from the Entry List [LOAD]

Press the ▲ or ▼ button to select a signal and press the ENTER button.

Editing a signal from the Entry List [EDIT]

1. Press the ▲ or ▼ button to select a signal you wish to edit.
2. Press the ◀, ▶, ▲, or ▼ button to select [EDIT] and press the ENTER button.

The Edit window will be displayed.

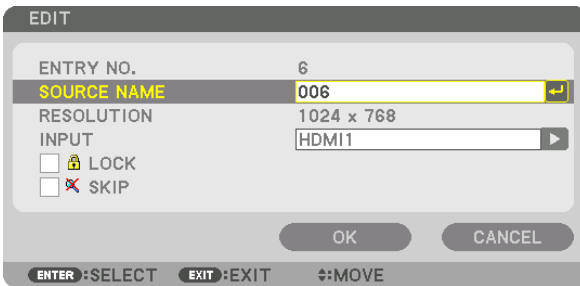

SOURCE NAME	Enter a signal name. Up to 18 alphanumeric characters can be used.
INPUT	The input terminal can be changed. The input terminal may be switched to HDMI1/HDMI2/Display Port/BNC/BNC(CV)/BNC(Y/C)/COMPUTER/HDBaseT ([ETHERNET] for MM models).
LOCK	Set so that the selected signal cannot be deleted when [ALL DELETE] is executed. The changes made after LOCK execution cannot be saved.
SKIP	Set so that the selected signal will be skipped during auto search.

3. Set the above items and select [OK] and press the ENTER button.

NOTE: The input terminal cannot be changed to the currently projected signal.

### Cutting a signal from the Entry List [CUT]

1. Press the ▲ or ▼ button to select a signal you wish to delete.
2. Press the ◀, ▶, ▲, or ▼ button to select [CUT] and press the ENTER button.

The signal will be deleted from the Entry List and the deleted signal will be displayed on the clipboard at the bottom of the Entry List.

---

#### NOTE:

- The currently projected signal cannot be deleted.
  - When the locked signal is selected, it will be displayed in gray which indicates it is not available.
- 

#### TIP:

- Data on the clipboard can be passed onto the Entry List.
- Data on the clipboard will not be lost after the Entry List is closed.

### Copying and pasting a signal from the Entry List [COPY] / [PASTE]

1. Press the ▲ or ▼ button to select a signal you wish to copy.
2. Press the ◀, ▶, ▲, or ▼ button to select [COPY] and press the ENTER button.  
The copied signal will be displayed on the clipboard at the bottom of the Entry List.
3. Press the ◀ or ▶ button to move to the list.
4. Press the ▲ or ▼ button to select a signal.
5. Press the ◀, ▶, ▲, or ▼ button to select [PASTE] and press the ENTER button.

Data on the clipboard will be pasted to the signal.

### Deleting all the signals from the Entry List [ALL DELETE]

1. Press the ◀, ▶, ▲, or ▼ button to select [ALL DELETE] and press the ENTER button.  
The confirmation message will be displayed.
2. Press the ◀ or ▶ button to select [YES] and press the ENTER button.

---

NOTE: The locked signal cannot be deleted.

---

## 5 Menu Descriptions & Functions [ADJUST] [PICTURE]

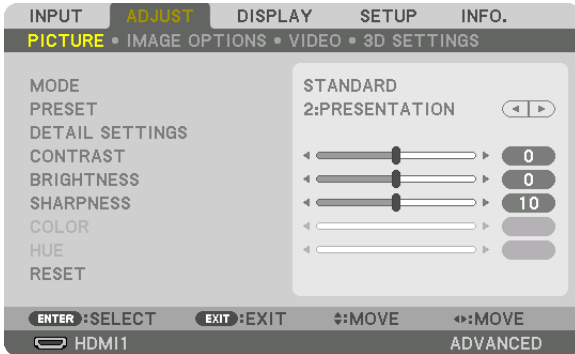

### [MODE]

This function allows you to determine how to save settings for [DETAIL SETTINGS] of [PRESET] for each input.

- STANDARD ..... Saves settings for each item of [PRESET] (Preset 1 through 7)
- PROFESSIONAL..... Saves all the settings of [PICTURE] for each input.

---

#### NOTE:

- When [TEST PATTERN] is displayed, [MODE] cannot be selected.
- 

### [PRESET]

This function allows you to select optimized settings for your projected image. You can adjust neutral tint for yellow, cyan or magenta.

There are seven factory presets optimized for various types of images. You can also use [DETAIL SETTINGS] to set user adjustable settings to customize each gamma or color.

Your settings can be stored in [PRESET 1] to [PRESET 7].

- HIGH-BRIGHT ..... Recommended for use in a brightly lit room.
- PRESENTATION ..... Recommended for making a presentation using a PowerPoint file.
- VIDEO ..... Recommended for typical TV program viewing.
- MOVIE ..... Recommended for movies.
- GRAPHIC ..... Recommended for graphics.
- sRGB ..... Standard color values
- DICOM SIM. .... Recommended for DICOM simulation format.

---

#### NOTE:

- The [DICOM SIM.] option is for training/reference only and should not be used for actual diagnosis.
  - DICOM stands for Digital Imaging and Communications in Medicine. It is a standard developed by the American College of Radiology (ACR) and the National Electrical Manufacturers Association (NEMA).  
The standard specifies how digital image data can be moved from system to system.
-

### [DETAIL SETTINGS]

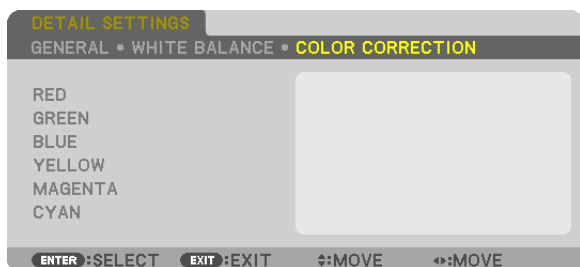
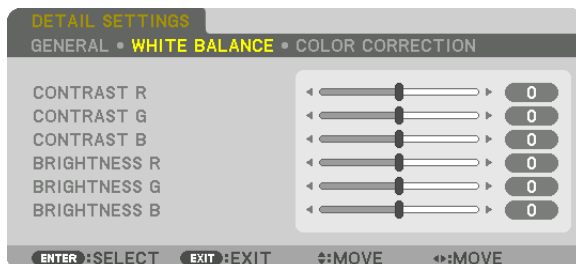
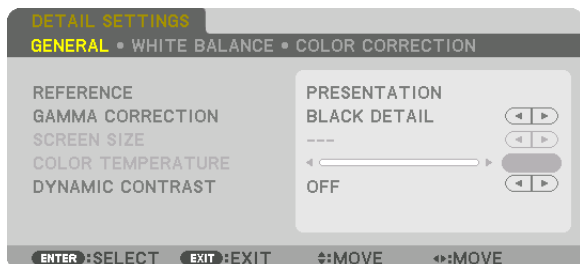

### [GENERAL]

#### Storing Your Customized Settings [REFERENCE]

This function allows you to store your customized settings in [PRESET 1] to [PRESET 7].

First, select a base preset mode from [REFERENCE], then set [GAMMA CORRECTION] and [COLOR TEMPERATURE].

- HIGH-BRIGHT ..... Recommended for use in a brightly lit room.
- PRESENTATION ..... Recommended for making a presentation using a PowerPoint file.
- VIDEO ..... Recommended for typical TV program viewing.
- MOVIE ..... Recommended for movies.
- GRAPHIC ..... Recommended for graphics.
- sRGB ..... Standard color values.
- DICOM SIM. .... Recommended for DICOM simulation format.

#### Selecting Gamma Correction Mode [GAMMA CORRECTION]

Each mode is recommended for:

- DYNAMIC ..... Creates a high-contrast picture.
- NATURAL ..... Natural reproduction of the picture.
- BLACK DETAIL ..... Emphasizes detail in dark areas of the picture.

---

*NOTE: This function is not available when [DICOM SIM.] is selected for [DETAIL SETTINGS].*

---

#### Selecting Screen Size for DICOM SIM [SCREEN SIZE]

This function will perform gamma correction appropriate for the screen size.

- LARGE ..... For screen size of 150"
- MEDIUM ..... For screen size of 100"
- SMALL ..... For screen size of 50"

---

*NOTE: This function is available only when [DICOM SIM.] is selected for [DETAIL SETTINGS].*

---



**Adjusting Color Temperature [COLOR TEMPERATURE]**

This option allows you to select the color temperature of your choice.  
A value between 5000 K and 10500 K can be set in 100 K units.

---

*NOTE: When [PRESENTATION] or [HIGH-BRIGHT] is selected in [REFERENCE], this function is not available.*

---

**Adjusting Brightness and Contrast [DYNAMIC CONTRAST]**

When set, the most optimal contrast ratio is adjusted according to the video.

OFF ..... Dynamic contrast is disabled.

MOTION IMAGE..... Most optimal settings for moving images.

STILL IMAGE..... Most optimal settings for static images. Rapidly follows any changes in the video.

---

*NOTE:*

• *Depending on the conditions, projector settings such as [DYNAMIC CONTRAST] may not be able to be selected.*

---

**Adjusting White Balance [WHITE BALANCE]**

This allows you to adjust the white balance. Contrast for each color (RGB) to adjust the white level of the screen;  
Brightness for each color (RGB) is used to adjust the black level of the screen.

**[COLOR CORRECTION]**

Corrects the color for all signals.

Adjusts the tone for the colors red, green, blue, yellow, magenta and cyan.

RED	HUE	+ Direction	Magenta direction
		- Direction	Yellow direction
	SATURATION	+ Direction	Vivid
		- Direction	Weak
GREEN	HUE	+ Direction	Yellow direction
		- Direction	Cyan direction
	SATURATION	+ Direction	Vivid
		- Direction	Weak
BLUE	HUE	+ Direction	Cyan direction
		- Direction	Magenta direction
	SATURATION	+ Direction	Vivid
		- Direction	Weak
YELLOW	HUE	+ Direction	Red direction
		- Direction	Green direction
	SATURATION	+ Direction	Vivid
		- Direction	Weak
MAGENTA	HUE	+ Direction	Blue direction
		- Direction	Red direction
	SATURATION	+ Direction	Vivid
		- Direction	Weak
CYAN	HUE	+ Direction	Green direction
		- Direction	Blue direction
	SATURATION	+ Direction	Vivid
		- Direction	Weak

**[CONTRAST]**

Adjusts the intensity of the image according to the incoming signal.

**[BRIGHTNESS]**

Adjusts the brightness level or the back raster intensity.

**[SHARPNESS]**

Controls the detail of the image.

### [COLOR]

Increases or decreases the color saturation level.

### [HUE]

Varies the color level from +/- green to +/- blue. The red level is used as reference.

Input signal	CONTRAST	BRIGHTNESS	SHARPNESS	COLOR	HUE
RGB system of "COMPUTER/Display-Port/HDMI/HDBaseT"*1	Yes	Yes	Yes	No	No
COMPONENT system of "COMPUTER/DisplayPort/HDMI/HDBaseT"*1	Yes	Yes	Yes	Yes	Yes
Composite Video/S-Video	Yes	Yes	Yes	Yes	Yes
USB-A*2, ETHERNET	Yes	Yes	Yes	No	No

Yes = Adjustable, No = Not adjustable

\*1 Signals from transmission devices supporting HDBaseT can be input for HDBaseT models only.

\*2 Signals from the USB-A port can be input for MM models only.

#### NOTE:

- When [TEST PATTERN] is displayed, [CONTRAST], [BRIGHTNESS], [SHARPNESS], [COLOR] and [HUE] cannot be adjusted.

### [RESET]

The settings and adjustments for [PICTURE] will be returned to the factory settings with the exception of the following; Preset numbers and [REFERENCE] within the [PRESET] screen.

The settings and adjustments under [DETAIL SETTINGS] within the [PRESET] screen that are not currently selected will not be reset.

**[IMAGE OPTIONS]**

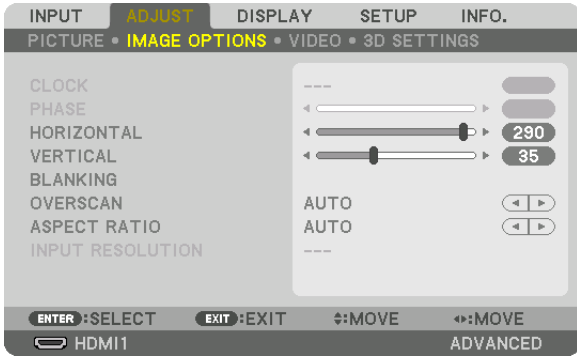

**Adjusting Clock and Phase [CLOCK/PHASE]**

This allows you to manually adjust CLOCK and PHASE.

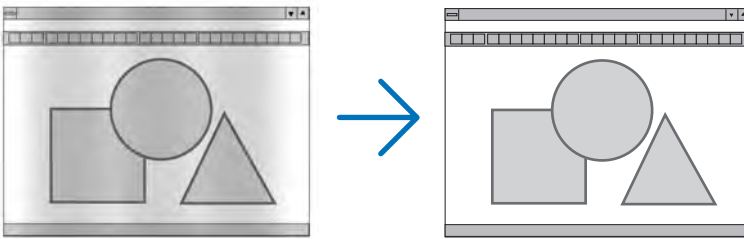

**CLOCK**..... Use this item to fine tune the computer image or to remove any vertical banding that might appear. This function adjusts the clock frequencies that eliminate the horizontal banding in the image. This adjustment may be necessary when you connect your computer for the first time.

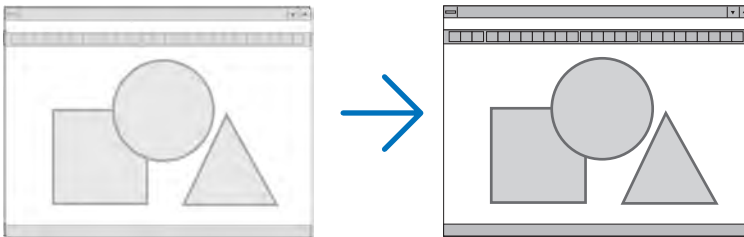

**PHASE**..... Use this item to adjust the clock phase or to reduce video noise, dot interference or cross talk. (This is evident when part of your image appears to be shimmering.) Use [PHASE] only after the [CLOCK] is complete.

---

*NOTE: The [CLOCK] and [PHASE] items are available for RGB signals only.*

---

**Adjusting Horizontal/Vertical Position [HORIZONTAL/VERTICAL]**

Adjusts the image location horizontally and vertically.

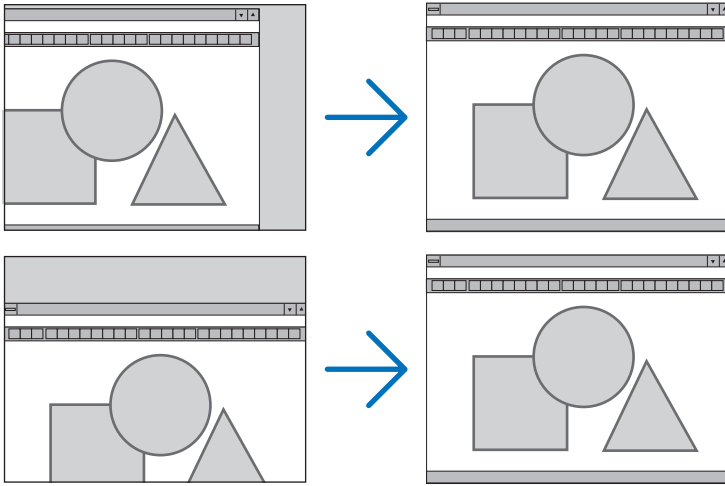

- An image can be distorted during the adjustment of [CLOCK] and [PHASE]. This is not malfunction.
- The adjustments for [CLOCK], [PHASE], [HORIZONTAL], and [VERTICAL] will be stored in memory for the current signal. The next time you project the signal with the same resolution, horizontal and vertical frequency, its adjustments will be called up and applied.  
To delete adjustments stored in memory, from the menu, you select [RESET] → [CURRENT SIGNAL] and reset the adjustments.

**[BLANKING]**

Adjusts the display range (blanking) at the top, bottom, left and right edges of the input signal.

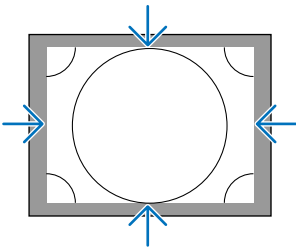

**Selecting Overscan Percentage [OVERSCAN]**

Select overscan percentage (Auto, 0%, 5% and 10%) for signal.

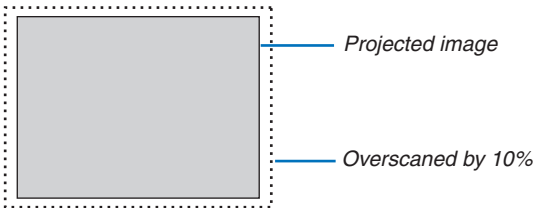

**NOTE:**

- The [OVERSCAN] item is not available:  
- when [NATIVE] is selected for [ASPECT RATIO].

### Selecting the Aspect Ratio [ASPECT RATIO]

Use this function to select the screen's vertical:horizontal aspect ratio.

Select the screen type (4:3 screen, 16:9 screen or 16:10 screen) at the screen setting before setting the aspect ratio. (→ page 112)

The projector automatically identifies the signal being input and sets the optimum aspect ratio.

#### For Computer signal

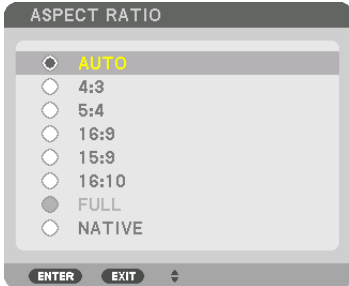

#### For Component/Video/S-Video signals

When the screen type is set to 4:3

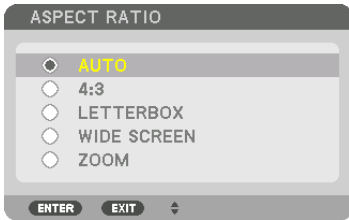

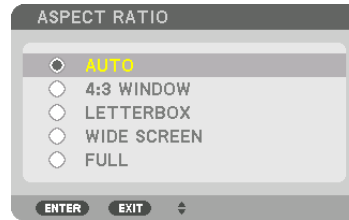

When the screen type is set to 16:9 or 16:10

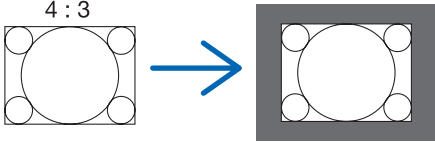
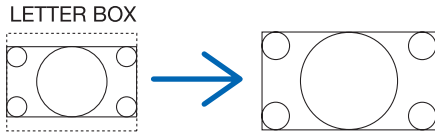
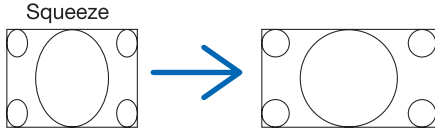

Resolution	Aspect Ratio	
VGA	640 × 480	4:3
SVGA	800 × 600	4:3
XGA	1024 × 768	4:3
WXGA	1280 × 768	15:9
WXGA	1280 × 800	16:10
HD(FWXGA)	1366 × 768	approx. 16:9
WXGA+	1440 × 900	16:10
SXGA	1280 × 1024	5:4
SXGA+	1400 × 1050	4:3
WXGA++	1600 × 900	16:9
UXGA	1600 × 1200	4:3
WSXGA+	1680 × 1050	16:10
FHD(1080P)	1920 × 1080	16:9
WUXGA	1920 × 1200	16:10
WQXGA	2560 × 1600	16:10

Options	Function
AUTO	The projector will automatically determine the incoming signal and display it in its aspect ratio. The projector may erroneously determine the aspect ratio depending on its signal. If this occurs, select the appropriate aspect ratio from the following.
4:3	The image is displayed in 4:3 aspect ratio.
5:4	The image is displayed in 5:4 aspect ratio
16:9	The image is displayed in 16:9 aspect ratio
15:9	The image is displayed in 15:9 aspect ratio
16:10	The image is displayed in 16:10 aspect ratio

Options	Function
<p>NATIVE</p>	<p>The projector displays the current image in its true resolution when the incoming computer signal has a lower or higher resolution than the projector's native resolution. (→ page 2)            When the incoming computer signal has a higher resolution than the projector's native resolution, the center of an image will be displayed.</p> 
<p>LETTER BOX</p>	<p>The image of a letterbox signal (16:9) is stretched equally in the horizontal and vertical directions to fit the screen.</p> 
<p>WIDE SCREEN</p>	<p>The image of a squeeze signal (16:9) is stretched left and right in 16:9.</p> 
<p>ZOOM</p>	<p>The image of a squeeze signal (16:9) is stretched left and right in 4:3.            Parts of the displayed image are cropped at the left and right edges and therefore not visible.</p> 
<p>FULL</p>	<p>Project to full screen size.</p>

**TIP:**

- Image position can be adjusted vertically using [POSITION] when the [16:9], [15:9], or [16:10] aspect ratios are selected.
- The term "letterbox" refers to a more landscape-oriented image when compared to a 4:3 image, which is the standard aspect ratio for a vide source.  
 The letterbox signal has aspect ratios with the vista size "1.85:1" or cinema scope size "2.35:1" for movie film.
- The term "squeeze" refers to the compressed image of which aspect ratio is converted from 16:9 to 4:3.

**[INPUT RESOLUTION]**

The resolution is assigned automatically when the resolution of the input signal from the computer video input terminal or BNC video input terminal (analog RGB) cannot be distinguished.

**[VIDEO]**



**Using Noise Reduction [NOISE REDUCTION]**

When projecting a video image, you can use the [NOISE REDUCTION] function to reduce the screen noise (roughness and distortion). This device is equipped with three types of noise reduction functions. Select the function according to the type of noise. Depending on the noise level, the noise reduction effect can be set to [OFF], [LOW], [MEDIUM] or [HIGH]. [NOISE REDUCTION] can be selected for SDTV, HDTV signal and component signal input.

- RANDOM NR ..... Reduces flickering random noise in an image.
- MOSQUITO NR ..... Reduces mosquito noise that appears around the edges of an image during Blu-ray playback.
- BLOCK NR ..... Reduces block noise or mosaic-like patterns by selecting ON.

**Selecting Interlaced Progressive Conversion Process Mode [DEINTERLACE]**

This function allows you to select an interlaced-to-progressive conversion process for video signals.

- NORMAL..... Automatically distinguishes a moving image from a static image to create a distinct image. Please select [MOVIE] if there are any obvious jitter and noises.
- MOVIE ..... Select when projecting moving images. This is suitable for signals with a lot of jitter and noise.
- STILL ..... Select when projecting static images. The video will flicker when a moving image is projected.

---

*NOTE: This function is not available with RGB signals.*

---

**[CONTRAST ENHANCEMENT]**

Using the characteristics of the human eye, a picture quality with a sense of contrast and resolution is achieved.

- OFF ..... Suite vision is switched off.
- AUTO ..... Contrast and picture quality are automatically improved using the suite vision function.
- NORMAL..... Adjust the gain manually.

### [SIGNAL TYPE]

Selection of RGB and component signals. Normally, this is set to [AUTO]. Please change the setting if the color of the image remains unnatural.

- AUTO ..... Automatically distinguishes RGB and component signals.
- RGB ..... Switches to the RGB input.
- COMPONENT ..... Switches to the component signal input.

### [VIDEO LEVEL]

Selection of the video signal level when connecting an external device to the HDMI 1 IN terminal, HDMI 2 IN terminal, DisplayPort input terminal, and HDBaseT\* input terminal of the projector.

\* For MM models, use the HDMI 1 input terminal, HDMI 2 input terminal and DisplayPort input terminal.

- AUTO ..... The video level is switched automatically based on the information from the device outputting the signal.  
Depending on the connected device, this setting may not be made properly. In this case, switch to [NORMAL] or "ENHANCED" from the menu and view with the optimum setting.
- NORMAL ..... This disables the enhanced mode.
- ENHANCED ..... This improves the image's contrast, expressing the dark and light sections more dynamically.
- SUPER WHITE ..... The video contrast is improved and the dark areas appear more dynamic.



**[3D SETTINGS]**

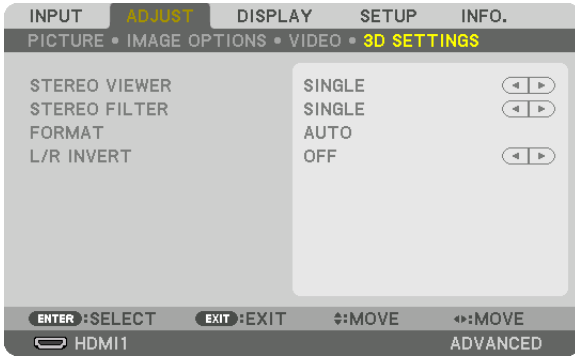

Please refer to “3-8 Projecting 3D videos” (→ page 41) for the operation.

**STEREO VIEWER**

Stack up a single or multiple projectors and carry out the settings for projecting 3D videos. Select the left / right settings of the 3D eyewear using the stereo viewer.

- SINGLE ..... Use a single projector to project 3D videos.
- DUAL LEFT ..... Use a dedicated projector for displaying videos on the left.
- DUAL RIGHT ..... Use a dedicated projector for displaying videos on the right.

**STEREO FILTER**

Stack up a single or multiple projectors and carry out the settings for projecting 3D videos. Image setting for 3D glasses made by Infitec.

- SINGLE ..... Use a single projector to project 3D videos.
- DUAL LEFT ..... Use a dedicated projector for displaying videos on the left.
- DUAL RIGHT ..... Use a dedicated projector for displaying videos on the right.

**FORMAT**

Select the 3D video format (recording / transmission format). Select to match the 3D broadcast and 3D media. Normally, [AUTO] is selected. Please select the 3D input signal format when the 3D detection signal of the format cannot be distinguished.

**L/R INVERT**

Invert the display order of the left and right videos.  
 Select [ON] if you feel uncomfortable with the 3D display when [OFF] is selected.

## ⑥ Menu Descriptions & Functions [DISPLAY] [PIP/PICTURE BY PICTURE]

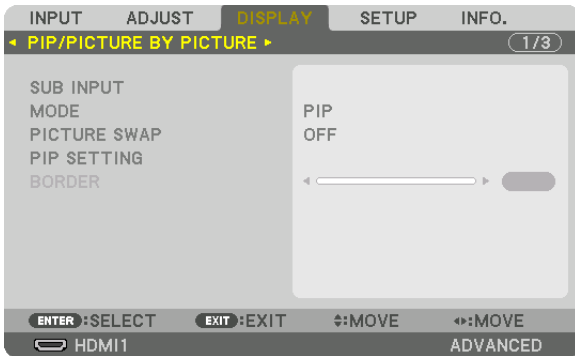

### SUB INPUT

Select the input signal to be displayed in the sub-display.

Please refer to “4-2 Displaying Two Pictures at the Same Time” (→ page 67) for details on the operation.

### MODE

Select either PIP or PICTURE BY PICTURE when switching to 2-screen display.

### PICTURE SWAP

The videos in the main display and sub-display will be switched.

Please refer to “4-2 Displaying Two Pictures at the Same Time” (→ page 69) for details.

### PIP SETTING

Select the display position, position adjustment and size of the sub-display in the PIP screen.

START POSITION... Selection of the display position of the sub-display when switching to the PIP screen.

#### HORIZONTAL POSITION

..... Adjust the display position of the sub-display in the horizontal direction. The respective corners will serve as reference points.

#### VERTICAL POSITION

..... Adjust the display position of the sub-display in the vertical direction. The respective corners will serve as reference points.

SIZE..... Select the display size of the sub-display.

**TIP:**

The horizontal position and vertical position are the amount of movement from the reference points. For example, when TOP-LEFT is adjusted, the position is displayed with the same amount of movement even if displayed with other starting positions. The maximum amount of movement is half the resolution of the projector.

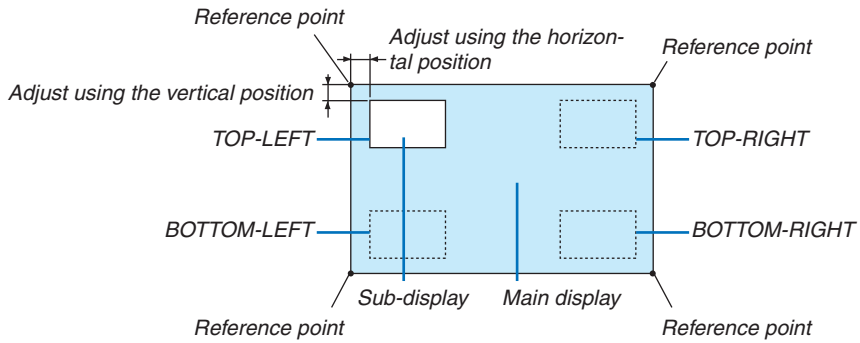

### BORDER

Select the display boundary of the main display and sub-display of the [PICTURE BY PICTURE] screen.

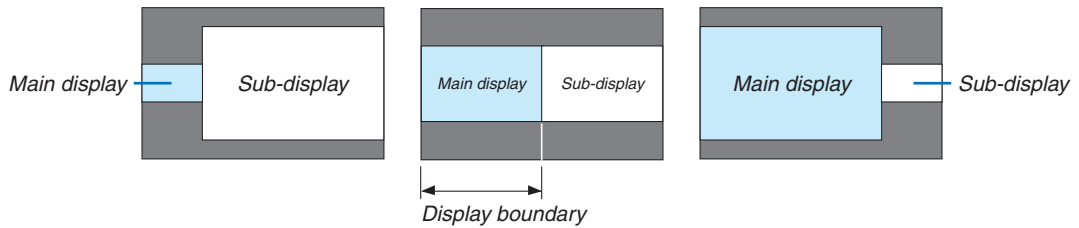

**TIP:**

- For WUXGA type, six steps can be selected.
- For WXGA type/XGA type, three steps can be selected.

**[GEOMETRIC CORRECTION]**

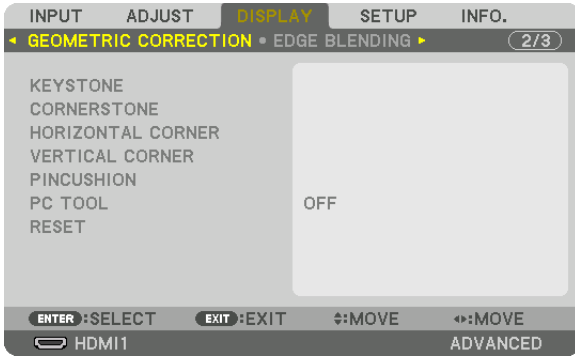

**KEYSTONE**

Display the trapezoid correction screen and adjust the trapezoidal distortion of the projection screen.

To display the [KEYSTONE] screen, select → [DISPLAY] → [GEOMETRIC CORRECTION] → [KEYSTONE] in the on-screen menu. The [GEOMETRIC CORRECTION] screen can also be displayed by pressing the Geometric. button on the remote control.

HORIZONTAL..... Adjustments when projecting from a diagonal direction to the screen.

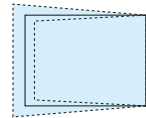

VERTICAL ..... Adjustments when projecting from the top or bottom direction to the screen.



TILT ..... Adjusts the distortion when performing trapezoidal correction with the screen moved in the vertical direction using the lens shift.

THROW RATIO..... Adjusts according to the projection ratio of the optional lens used.

Model name of lens unit	Adjustment range
NP11FL	8
NP30ZL	8–10
NP12ZL	12–15
NP13ZL	15–30
NP14ZL	29–47
NP15ZL	46–71

**NOTE:**

- When power is supplied to the device, the adjustment value of the [KEYSTONE] used previously is retained even if the gradient of the device is changed.
- When clearing the adjustment value of [KEYSTONE], press the Geometric. button for 2 or more seconds.
- When setting other [GEOMETRIC CORRECTION] functions, the [KEYSTONE] menu cannot be selected. When performing trapezoidal correction, press the Geometric. button for 2 or more seconds to clear the adjustment value of [GEOMETRIC CORRECTION].
- As electrical correction is carried out by [KEYSTONE], the brightness may be reduced or the screen quality may deteriorate sometimes.

**CORNERSTONE**

Display the 4-point correction screen and adjust the trapezoidal distortion of the projection screen. Please refer to “Correcting Horizontal and Vertical Keystone Distortion [CORNERSTONE]” (→ page 35) for details on the operation.

**HORIZONTAL CORNER/VERTICAL CORNER**

Distortion correction for corner projection such as wall surfaces.

**HORIZONTAL CORNER**

..... Performs correction for projection onto a wall lying at an angle to the horizontal direction.

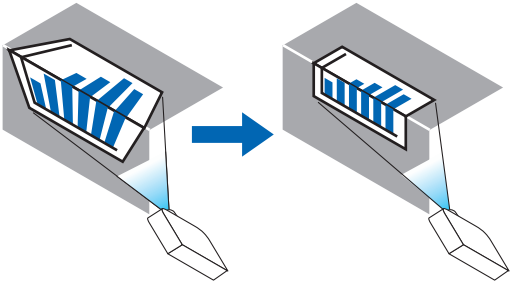

\* Reverse angle correction is also possible.

**VERTICAL CORNER**

..... Performs correction for projection onto a wall lying at an angle to the vertical direction.

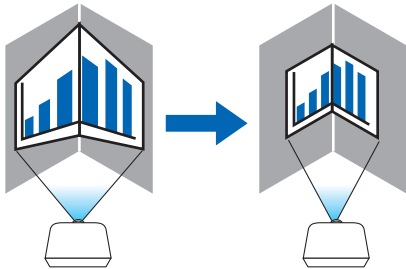

\* Reverse angle correction is also possible.

---

**NOTE:**

- When the maximum adjustment range is exceeded, distortion adjustment is disabled. Set up the projector at an optimal angle as the deterioration in the image quality increases as the distortion adjustment volume gets larger.
- Please note that the image will go out of focus due to the difference in the distance between the upper and lower or left and right sides and the center of the screen for projections cutting across corners. Lenses with short focal points are also not recommended for projections cutting across corners as the image will go out of focus.

---

### Adjustment method

1. **Align the cursor with the [HORIZONTAL CORNER] or [VERTICAL CORNER] of the [GEOMETRIC CORRECTION] menu and then press the ENTER button.**
  - The adjustment screen will be displayed.
2. **Press the ▼▲◀▶ buttons to align the cursor (yellow box) with the target adjustment point and then press the ENTER button.**
  - The cursor will change into an adjustment point (yellow in color).
3. **Press the ▼▲◀▶ buttons to adjust the corners or sides of the screen and then press the ENTER button.**
  - The adjustment point will go back to being a cursor (yellow box).

#### Explanation of screen transition

- The adjustment points of the four corners (a, c, f and h in the drawing) will move independently.
- The following adjustment points differ at the [HORIZONTAL CORNER] and [VERTICAL CORNER].  
**HORIZONTAL CORNER:** When Point b in the drawing is moved, and the upper side and Point g are moved, the lower side will move in a parallel manner.

**VERTICAL CORNER:** When Point d in the drawing is moved, and the left side and Point e are moved, the right side will move in a parallel manner.

[Adjustment points of the [HORIZONTAL CORNER] screen and movement points of the projection screen]

Point b will be displaced in a parallel manner at the same time as Points a, b, c

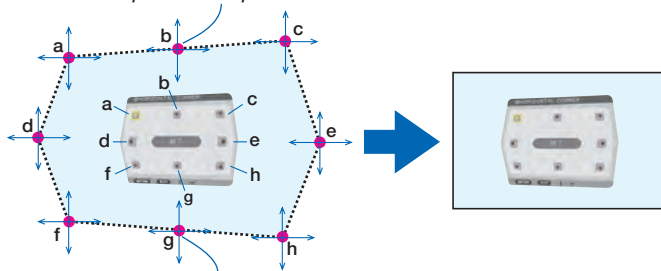

Point g will be displaced in a parallel manner at the same time as Points f, g, h

[Adjustment points of the [VERTICAL CORNER] screen and movement points of the projection screen]

Point d will be displaced in a parallel manner at the same time as Points a, d, f

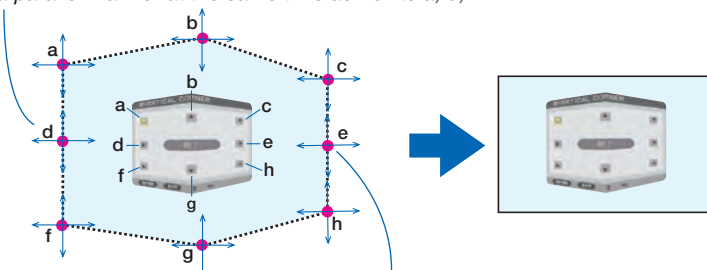

Point e will be displaced in a parallel manner at the same time as Points f, g, h

4. **Start from Step 2 onwards to adjust the other points.**
5. **When the adjustment is completed, press the ▼▲◀▶ buttons to align the cursor with the [EXIT] in the adjustment screen and then press the ENTER button.**
  - Switch to the [GEOMETRIC CORRECTION] menu screen.

### PINCUSHION

Adjust the curve distortion of the projection screen.

- TOP..... Adjust the curve distortion of the upper edge of the projection screen.
- BOTTOM..... Adjust the curve distortion of the lower edge of the projection screen.
- LEFT ..... Adjust the curve distortion of the left edge of the projection screen.
- RIGHT..... Adjust the curve distortion of the right edge of the projection screen.

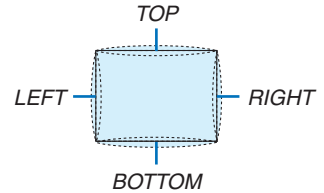

### PC TOOL (For future support)

Recall the geometric correction data that is registered in the projector beforehand. There are three types of registered data.

---

#### NOTE:

- *KEYSTONE, CORNERSTONE, and PINCUSHION cannot be selected when setting the geometric correction using a PC tool.*
  - *To clear the [GEOMETRIC CORRECTION] data that has been set up, press the Geometric. button for 2 or more seconds.*
  - *As electrical correction is carried out in geometric correction, the brightness may be affected and the picture quality may be degraded.*
- 

### RESET

Reset the adjustment value that has been set up in GEOMETRIC CORRECTION (return to the initial value).

**[EDGE BLENDING]**

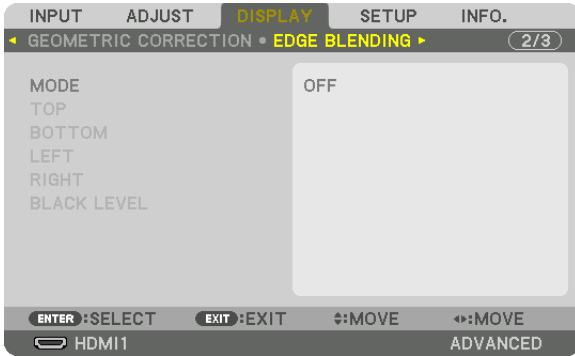

This adjusts the edges (boundaries) of the projection screen when projecting high resolution videos using a combination of several projectors in the up, down, left and right positions.

**MODE**

This enables or disables the EDGE BLENDING function. When MODE is set to ON, the TOP, BOTTOM, LEFT, RIGHT and BLACK LEVEL settings can be adjusted.

**TOP/BOTTOM/LEFT/RIGHT**

This selects the EDGE BLENDING locations on the left, right, top and bottom on the screen. The following settings can be adjusted when an item is selected. (→ page 71)

- CONTROL ..... Enable TOP, BOTTOM, LEFT and RIGHT functions.
- MARKER..... Set whether to display marker or not when adjusting the range and display position. When turned on, a magenta marker for adjusting the range adjustment and a green marker for adjusting the display position will be displayed.
- RANGE..... Adjust the range (width) of the edge blending.
- POSITION ..... Adjust the display position of the edge blending.

**BLACK LEVEL**

Divide the screen into nine parts and keep the black level uniform for each projector. The nine divisions screens are TOP-LEFT, TOP-CENTER, TOP-RIGHT, CENTER-LEFT, CENTER, CENTER-RIGHT, BOTTOM-LEFT, BOTTOM-CENTER and BOTTOM-RIGHT. (→ page 75)



**[MULTI SCREEN]**



**WHITE BALANCE**

This adjusts the white balance for each projector when projecting using a combination of several projectors. This can be adjusted when [MODE] is set to [ON].

- BRIGHTNESS W, BRIGHTNESS R, BRIGHTNESS G, BRIGHTNESS B  
..... Adjusting the black color of the video.
- CONTRAST W, CONTRAST R, CONTRAST G, CONTRAST B  
..... Adjusting the white color of the video.

**PICTURE SETTING**

This sets the division condition when projecting using a combination of several projectors. Please refer to “4. Multi-Screen Projection” (→ page 63) for details.

MODE	OFF	Use the projector in a standalone state.
	ZOOM	This adjusts the position and width of the video area that you wish to divide. The edge blending width will also be automatically set to that width.
	TILING	This assigns the divided screens to the projectors. The edge blending function will also be set automatically.
ZOOM	HORIZONTAL ZOOM	This enlarges the video area in the horizontal direction.
	VERTICAL ZOOM	This enlarges the video area in the vertical direction.
	HORIZONTAL POSITION	This shifts the video area in the horizontal direction.
	VERTICAL POSITION	This shifts the video area in the vertical direction.
TILING	WIDTH	This selects the number of projectors to be arranged horizontally.
	HEIGHT	This selects the number of projectors to be arranged vertically.
	HORIZONTAL POSITION	This selects the position of the projector starting from the left among those arranged horizontally.
	VERTICAL POSITION	This selects the position of the projector starting from the top among those arranged vertically.

### Conditions for using tiling

- All the projectors need to fulfil the following conditions.
  - The panel size must be the same
  - The projection screen size must be the same
  - The left and right ends or top and bottom ends of the projection screen must be consistent.
  - The settings for the left and right edges of the edge blending are the same
  - The settings for the top and bottom edges of the edge blending are the same

If the tiling conditions are satisfied, the video screen of the projector at each installation position will be automatically extracted and projected.

If the tiling conditions are not satisfied, adjust the video screen of the projector at each installation position using the zoom function.

- Assign a unique control ID to each projector.
- Set the “Color setting” and “DeepColor setting” on your Blu-ray player or computer to “Auto”. Refer to the owner's manual accompanied with your Blu-ray player or computer for more information. Connect an HDMI output of your Blu-ray player or computer to the first projector and then connect to the HDMI1 or HDMI2 input connector of the second and subsequent projectors.

**Tiling setting example) Number of horizontal units = 2, Number of vertical units = 2**

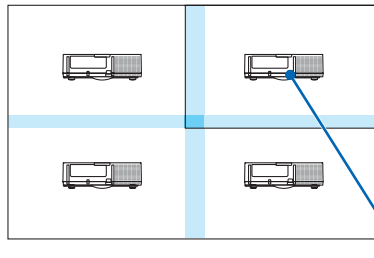

*Horizontal order = Second unit  
Vertical order = First unit*

## 7 Menu Descriptions & Functions [SETUP]

### [MENU]



#### Selecting Menu Language [LANGUAGE]

You can choose one of 29 languages for on-screen instructions.

---

*NOTE: Your setting will not be affected even when [RESET] is done from the menu.*

---

#### Selecting Menu Color [COLOR SELECT]

You can choose between two options for menu color: COLOR and MONOCHROME.

#### Turning On / Off Source Display [INPUT DISPLAY]

This option turns on or off input name display such as HDMI1, HDMI2, DisplayPort, BNC, BNC(CV), BNC(Y/C), COMPUTER, HDBaseT to be displayed on the top right of the screen.

#### Turning messages on and off [MESSAGE DISPLAY]

This option selects whether or not to display projector messages at the bottom of the projected image. Even when "OFF" is selected, the security lock warning is displayed. The security lock warning turns off when the security lock is canceled.

#### Turning ON/OFF Control ID [ID DISPLAY]

ID DISPLAY ..... This option turns on or off the ID number which is displayed when the ID SET button on the remote control is pressed. (→ page 120)

### Turning On / Off Eco Message [ECO MESSAGE]

This option turns on or off the following messages when the projector is turned on.

The Eco Message prompts the user to save energy. When [OFF] is selected for [ECO MODE], you will get a message to prompt you to select [ON] for [ECO MODE].

When [ON] is selected for [ECO MODE]

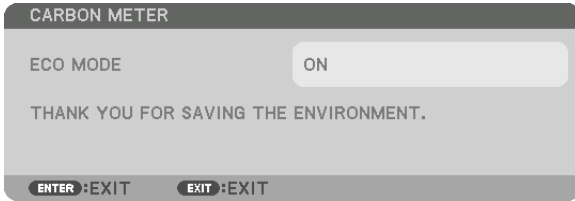

To close the message, press any one of the buttons. The message will disappear if no button operation is done for 30 seconds.

When [OFF] is selected for [ECO MODE]

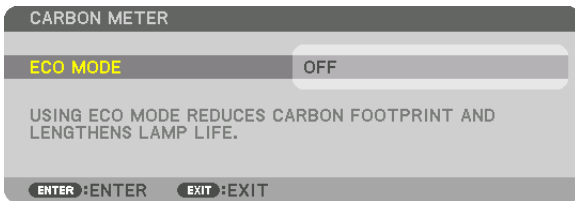

Pressing the ENTER button will display the [ECO MODE] screen. (→ page 31)

To close the message, press the EXIT button.

### [3D CAUTION MESSAGE]

This selects whether to display a caution message or not when switching to a 3D video.

The default condition when shipped from the factory is ON.

OFF ..... The 3D caution message screen will not be displayed.

ON ..... The 3D caution message screen will be displayed when switching to a 3D video. Press the ENTER button to cancel the message.

- The message will disappear automatically after 60 seconds or when other buttons are pressed. If it disappears automatically, the 3D caution message will be displayed again when switching to a 3D video.

### Selecting Menu Display Time [DISPLAY TIME]

This option allows you to select how long the projector waits after the last touch of a button to turn off the menu. The preset choices are [MANUAL], [AUTO 5 SEC], [AUTO 15 SEC], and [AUTO 45 SEC]. The [AUTO 45 SEC] is the factory preset.

### Selecting Interval Time for Filter Message [FILTER MESSAGE]

This option allows you to select the time preference between displaying the message for cleaning the filters. Clean the filter when you get the message "PLEASE CLEAN FILTER." (→ page 174)

Five options are available: OFF, 100[H], 500[H], 1000[H], 2000[H]

The default setting is [OFF].

---

*NOTE: Your setting will not be affected even when [RESET] is done from the menu.*

---

**[INSTALLATION]**

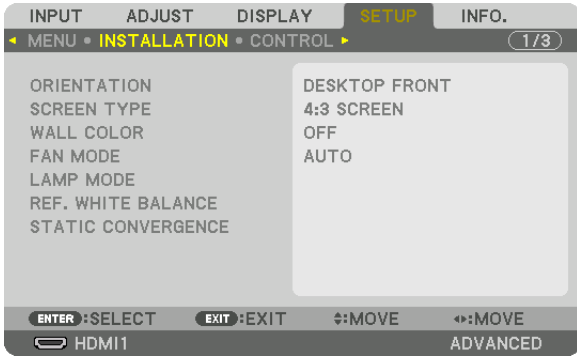

**Selecting Projector Orientation [ORIENTATION]**

This reorients your image for your type of projection. The options are: desktop front projection, ceiling rear projection, desktop rear projection, and ceiling front projection.

**NOTE:**

- Please consult the retail store if you require special installation services e.g. when mounting the projector to a ceiling. Never install the projector on your own. This may result in the projector falling down and causing injury to people.
- When using the projector suspended from a ceiling, ensure that people do not stay below the projector. In the event the lamp were to break, there is a risk that glass fragments may fall from the projector.

AUTO ..... This automatically detects and projects the DESKTOP FRONT and CEILING FRONT.

**NOTE:**

- The DESKTOP REAR and CEILING REAR will not be detected. Please select manually.

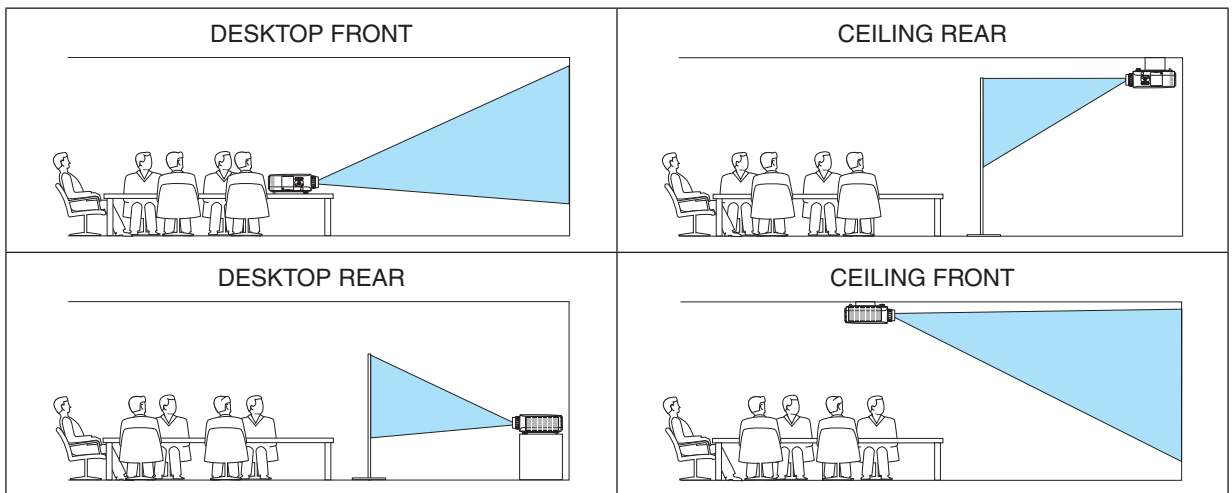

**TIP:**

- Check whether the automatic DESKTOP FRONT is installed within  $\pm 10$  degrees for floor installation and whether the CEILING FRONT is within  $\pm 10$  degrees for ceiling installation. Select manually when the projection screen is inverted.

**Selecting Aspect Ratio and Position for Screen [SCREEN TYPE]**

Screen type	Sets the aspect ratio of the projection screen.	
	FREE	The ratio of the liquid crystal panel is selected. Select this when projecting multi-screen and 17:9 screen (2K).
	4:3 screen	For a screen with a 4:3 aspect ratio
	16:9 screen	For a screen with a 16:9 aspect ratio
	16:10 screen	For a screen with a 16:10 aspect ratio

**NOTE:**

- After changing the screen type, check the setting of [ASPECT RATIO] in the menu. (→ page 95)

**Using the Wall Color Correction [WALL COLOR]**

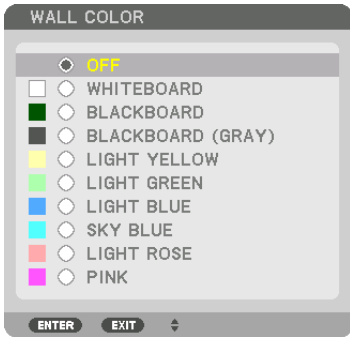

This function allows for quick adaptive color correction in applications where the screen material is not white.

**NOTE:** Selecting [WHITEBOARD] reduces lamp brightness.

**Selecting Fan Mode [FAN MODE]**

Fan Mode is used to set the speed of the internal cooling fan.

MODE ..... Select three modes for fan speed: AUTO, HIGH, and HIGH ALTITUDE.

AUTO: The built-in fans automatically run at a variable speed according to the internal temperature.

HIGH: The built-in fans run at high speed

HIGH ALTITUDE: The built-in fans run at a high speed. Select this option when using the projector at altitudes approximately 5500 feet/1700 meters or higher.

**NOTE:**

- Make sure the speed is set to [HIGH] when you are using this device continuously for several days.
- Set [FAN MODE] to [HIGH ALTITUDE] when using the projector at altitudes approximately 5500 feet/1700 meters or higher.
- Using the projector at altitudes approximately 5500 feet/1700 meters or higher without setting to [HIGH ALTITUDE] can cause the projector to overheat and the protector could shut down. If this happens, wait a couple minutes and turn on the projector.
- Using the projector at altitudes less than approximately 5500 feet/1700 meters and setting to [HIGH ALTITUDE] can cause the lamp to overcool, causing the image to flicker. Switch [FAN MODE] to [AUTO].
- Using the projector at altitudes approximately 5500 feet/1700 meters or higher can shorten the life of optical components such as the lamp.
- Your setting will not be affected even when [RESET] is done from the menu.

**TIP:**

- When [HIGH ALTITUDE] is selected for [FAN MODE], a symbol icon  will be displayed at the bottom of the menu.

**[LAMP MODE]**

When eco-mode is set to [ON], the CO<sub>2</sub> emissions (calculated from the reduction in power consumption) of the projector can be reduced. The eco-mode reduces power consumption by mainly lowering the brightness of the lamp. As a result, the lamp replacement time (as a guide)\* is extended. (→ page 31, 133)

\* Replacement time not guaranteed.

LAMP ADJUST..... This can be set when the eco-mode is set to [OFF]. Adjust the lamp to match the brightness of each projector when projecting a multi-screen display using multiple projectors.

ECO MODE	OFF	The lamp luminance (brightness) will become 100% and the screen will turn bright. The luminance of the lamp can be set using the lamp adjustment.
	ON	The lamp luminance (brightness) will become approximately 80% and the lamp replacement time (estimated)* will be extended. * The replacement time is not guaranteed.
LAMP ADJUST		When the [ECO MODE] is set to [OFF], [LAMP ADJUST] is enabled. Adjust the lamp to match the brightness of each projector when projecting a multi-screen display using multiple projectors.

**[REF. WHITE BALANCE]**

This feature allows you to adjust the white balance for all signals.

The white and black levels of the signal are adjusted for optimum color reproduction.

Uniformity is also adjusted when the redness (R) and blueness (B) of the white color in the screen's horizontal (left/right) direction are uneven.

CONTRAST R/CONTRAST G/CONTRAST B

..... These adjust the picture's white color.

BRIGHTNESS R/BRIGHTNESS G/BRIGHTNESS B

..... These adjust the picture's black color.

UNIFORMITY R..... The further this is set to the + side, the stronger the redness on the left side of the picture (increasing towards the left edge) and the weaker the redness on the right side of the picture (decreasing towards the right edge).

This is reversed when set to the – side.

UNIFORMITY B..... The further this is set to the + side, the stronger the blueness on the left side of the picture (increasing towards the left edge) and the weaker the blueness on the right side of the picture (decreasing towards the right edge).

This is reversed when set to the – side.

**[STATIC CONVERGENCE]**

This features allows you to adjust for color deviation in the picture.

This can be adjusted in units of ± 1 pixel in the horizontal direction for HORIZONTAL R, G and B, in the vertical direction for VERTICAL R, G and B.

**[CONTROL]**

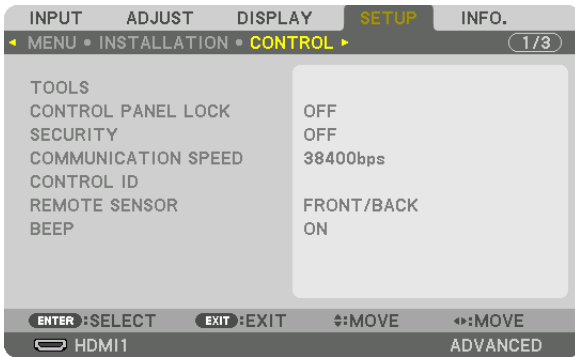

**TOOLS**

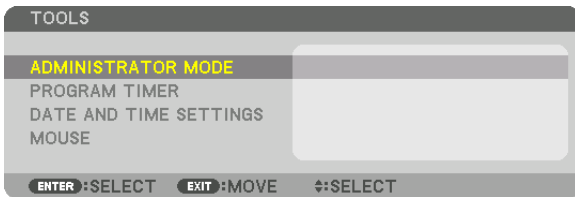

**ADMINISTRATOR MODE**

This allows you to select MENU MODE, save settings, and set a password for the administrator mode.

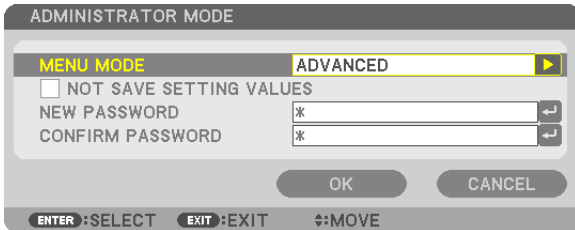

MENU MODE	Select either [BASIC] or [ADVANCED] menu. (→ page 114)	—
NOT SAVE SETTING VALUES	Placing a check mark will not save your projector settings. Clear this check box to save your projector settings.	—
NEW PASSWORD/ CONFIRM PASS- WORD	Assign a password for the administrator mode.	Up to 10 alphanumeric characters



**PROGRAM TIMER**

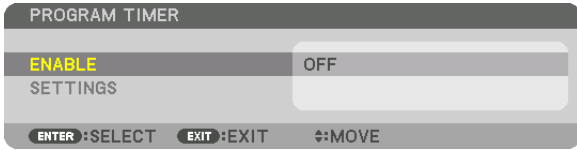

This option turns on/standby the projector and changes video signals, and selects ECO mode automatically at a specified time.

**NOTE:**

- Before using [PROGRAM TIMER], make sure that the [DATE AND TIME] feature is set. (→ page 118)  
 Make sure that the projector is in the standby condition with the POWER cord connected.  
 The projector has a built-in clock. The clock will keep working for about two weeks after the main power is turned off. If the main power is not supplied to the projector for two weeks or more, the built-in clock stops working.

**Setting a new program timer**

1. On the PROGRAM TIMER screen, use the ▲ or ▼ button to select [SETTINGS] and press the ENTER button.

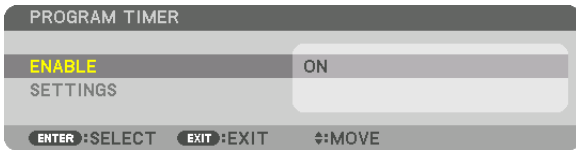

The [PROGRAM LIST] screen will be displayed.

2. Select a blank program number and press the ENTER button.

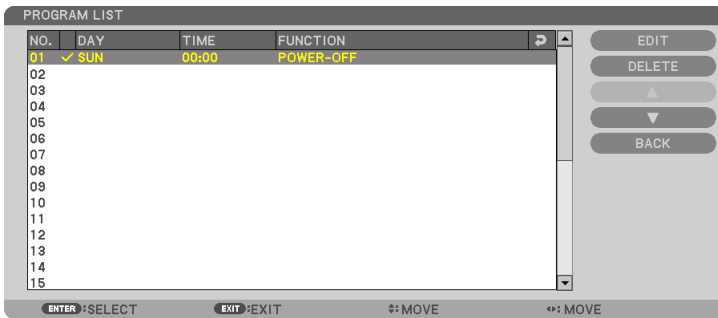

The [EDIT] screen will be displayed.

3. Make settings for each item as required.

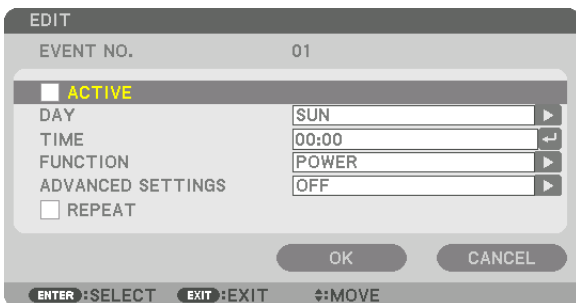

ACTIVE ..... Place a check mark to enable the program.

DAY ..... Select days of the week for the program timer. To execute the program from Monday to Friday, select [MON-

FRI]. To execute the program in everyday basis, select [EVERYDAY].

TIME ..... Set the time to execute the program. Enter time in 24-hour format.

FUNCTION ..... Select a function to be executed. Selecting [POWER] will allow you to turn on or off the projector by setting [ADVANCED SETTINGS]. Selecting [INPUT] will allow you to select a video source by setting [ADVANCED SETTINGS]. Selecting [ECO MODE] will allow you to select [ECO MODE] by setting [ADVANCED SETTINGS].

ADVANCED SETTINGS

..... Select power on/off, a type of video source, or ECO MODE for the selected item in [FUNCTION].

REPEAT..... Place a check mark to repeat the program continuing basis. To use the program this week only, clear the check mark.

#### 4. Select [OK] and press the ENTER button.

*This will complete the settings.*

*You will be returned to the [PROGRAM LIST] screen.*

#### 5. Select [BACK] and press the ENTER button.

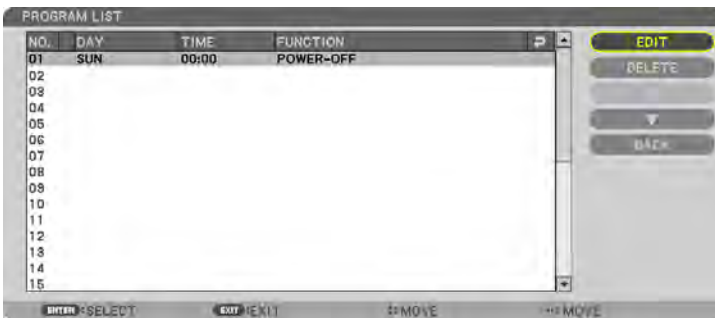

*You will be returned to the [PROGRAM TIMER] screen.*

#### 6. Press the EXIT button.

*You will be returned to the [TOOLS] screen.*

#### NOTE:

- Up to 30 different timer settings can be programmed.
- When [PROGRAM TIMER] is turned on, the [STANDBY MODE] setting is ignored.
- The Program Timer is executed on a set time basis, not in a program basis.
- Once the program not marked with a check in [REPEAT] has been executed, the check mark in the [ACTIVE] check box will be cleared automatically and the program will be disabled.
- When the on-time and the off-time set for the same time, the off-time setting will take preference.
- Two different sources are set for the same time, the larger program number will take preference.
- The on-time setting will not be executed while the cooling fans are running or an error is occurring.
- If the off-time setting is expired under the condition in which the power off is not possible, the off-timer setting will not be executed until the power off becomes possible.
- Programs not marked with a check mark in [ACTIVE] of the [EDIT] screen will not be executed even if the Program Timer is enabled.
- When the projector is turned on by using the program timer and if you want to turn off the projector, set the off-time or do it manually so as not to leave the projector on for a long period of time.

### Activating the program timer

1. Select **[ENABLE]** on the **[PROGRAM TIMER]** screen and press the **ENTER** button.

*The selection screen will be displayed.*

2. Press the **▼** button to align the cursor with **[ON]** and then press the **ENTER** button.

*Return to the [PROGRAM TIMER] screen.*

---

#### NOTE:

- When the effective settings of the **[PROGRAM TIMER]** have not been set to **[ON]**, the program will not be executed even if the **[ACTIVE]** items in the program list have been ticked.
  - Even when the effective settings of the **[PROGRAM TIMER]** are set to **[ON]**, the **[PROGRAM TIMER]** will not work until the **[PROGRAM TIMER]** screen is closed.
- 

### Changing the programmed settings

1. On the **[PROGRAM LIST]** screen, select a program you want to edit and press the **ENTER** button.

2. Change the settings on the **[EDIT]** screen.

3. Select **[OK]** and press the **ENTER** button.

*The programmed settings will be changed.*

*You will be returned to the [PROGRAM LIST] screen.*

### Changing the order of programs

1. On the **[PROGRAM LIST]** screen, select a program whose order you want to change and press the **►** button.

2. Press the **▼** button to select **▲** or **▼**.

3. Press the **ENTER** button a few times to select a row to which you wish to move the program.

*The order of the programs will be changed.*

### Deleting the programs

1. On the **[PROGRAM LIST]** screen, select a program number you want to delete and press the **►** button.

2. Press the **▼** button to select **[DELETE]**.

3. Press the **ENTER** button.

*The confirmation screen will be displayed.*

4. Select **[YES]** and press the **ENTER** button.

*The program will be deleted.*

*This will complete deleting the program.*

### DATE AND TIME SETTINGS

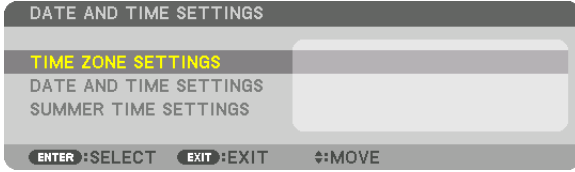

You can set the current time, month, date, and year.

*NOTE: The projector has a built-in clock. The clock will keep working for about 2 weeks after the main power is turned off. If the main power is off for 2 weeks or more, the built-in clock will cease. If the built-in clock ceases, set the date and time again. The built-in clock will not cease while in the standby mode.*

TIME ZONE SETTINGS..... Select your time zone.

DATE AND TIME SETTINGS ..... Set your current date (MM/DD/YYYY) and time (HH:MM).

INTERNET TIME SERVER ..... If you place a check mark, the projector's built-in clock will be synchronized with an Internet time server in every 24 hours and at the time of projector's startup.

UPDATE ..... Synchronizes the projector's built-in clock immediately. The UPDATE button is not available unless the INTERNET TIME SERVER check box is turned on.

SUMMER TIME SETTINGS ..... If you place a check mark, the clock for daylight saving will be enabled.

### [MOUSE]

This function cannot be used in this device. It is used for future expansion purposes only.

### Disabling the Cabinet Buttons [CONTROL PANEL LOCK]

This option turns on or off the CONTROL PANEL LOCK function.

---

**NOTE:**

- *How to cancel the [CONTROL PANEL LOCK]*  
When the [CONTROL PANEL LOCK] is set to [ON], press the EXIT button or the INPUT button on the main body for about 10 seconds to cancel the [CONTROL PANEL LOCK] setting.
- 

**TIP:**

- *When the [CONTROL PANEL LOCK] is turned on, a key lock icon [  ] will be displayed at the bottom right of the menu.*
- *This CONTROL PANEL LOCK does not affect the remote control functions.*

### Enabling Security [SECURITY]

This feature turns on or off the SECURITY function.

Unless the correct keyword is entered, the projector cannot project an image. (→ page 38)

---

*NOTE: Your setting will not be affected even when [RESET] is done from the menu.*

---

### Selecting Communication Speed [COMMUNICATION SPEED]

This feature sets the baud rate of the PC Control port (D-Sub 9P). It supports data rates from 4800 to 115200 bps. The default is 38400 bps. Select the appropriate baud rate for your equipment to be connected (depending on the equipment, a lower baud rate may be recommended for long cable runs).

---

**NOTE:**

- *Select [38400bps] or less when using the supplied software programs.*
  - *Your selected communication speed will not be affected even when [RESET] is done from the menu.*
-

### Setting ID to the Projector [CONTROL ID]

You can operate multiple projectors separately and independently with the single remote control that has the CONTROL ID function. If you assign the same ID to all the projectors, you can conveniently operate all the projectors together using the single remote control. To do so, you have to assign an ID number to each projector.

CONTROL ID NUMBER..... Select a number from 1 to 254 you wish to assign to your projector.

CONTROL ID..... Select [OFF] to turn off the CONTROL ID setting and select [ON] to turn on the CONTROL ID setting.

#### NOTE:

- When [ON] is selected for [CONTROL ID], the projector cannot be operated by using the remote control that does not support the CONTROL ID function. (In this case the buttons on the projector cabinet can be used.)
- Your setting will not be affected even when [RESET] is done from the menu.
- Pressing and holding the ENTER button on the projector cabinet for 10 seconds will display the menu for canceling the Control ID.

### Assigning or Changing the Control ID

#### 1. Turn on the projector.

#### 2. Press the ID SET button on the remote control.

The CONTROL ID screen will be displayed.

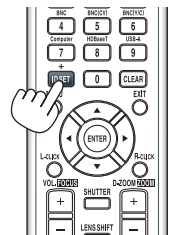

If the projector can be operated with the current remote control ID, the [ACTIVE] will be displayed. If the projector cannot be operated with the current remote control ID, the [INACTIVE] will be displayed. To operate the inactive projector, assign the control ID used for the projector by using the following procedure (Step 3).

#### 3. Press one of numeric keypad buttons while pressing and holding the ID SET button on the remote control.

##### Example:

To assign "3", press the "3" button on the remote control.

No ID means that all the projectors can be operated together with a single remote control. To set "No ID", enter "000" or press the CLEAR button.

TIP: The range of IDs is from 1 to 254.

#### 4. Release the ID SET button.

The updated CONTROL ID screen will be displayed.

#### NOTE:

- The IDs can be cleared in a few days after the batteries are run down or removed.
- Accidentally pressing any one of the buttons of the remote control will clear currently specified ID with batteries removed.

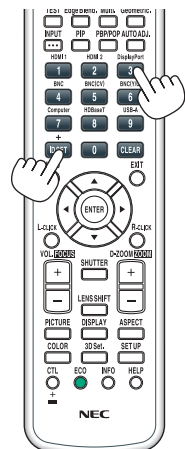

### Turning On or Off Remote Sensor [REMOTE SENSOR]

This option determines which remote sensor on the projector is enabled in wireless mode. The options are: FRONT/BACK, FRONT, BACK, and HDBaseT\*.

\* Only HDBaseT models will be displayed.

---

#### NOTE:

- *The remote control of the projector will not be able to receive signals if the power supply of the HDBaseT transmission device connected to the projector is switched on when this has been set to "HDBaseT".*
- 

#### TIP:

- *If the remote control system does not function when direct sunlight or strong illumination strikes the remote control sensor of the projector, change another option.*

### Enabling Key Sound and Error Sound [BEEP]

This feature turns on or off the button sound or alarm when an error occurs or the following operations are performed.

- Displaying the main menu
- Switching sources
- Resetting data by using [RESET]
- Pressing POWER ON or STANDBY button

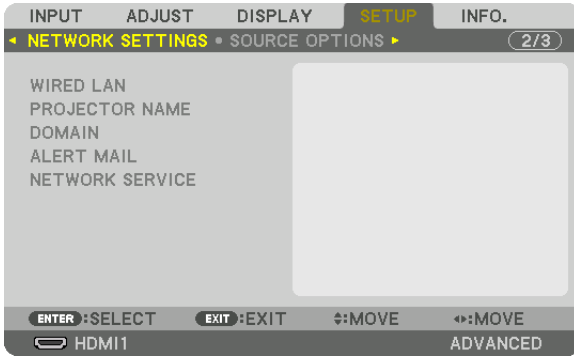
**[NETWORK SETTINGS]***Important:*

- Consult with your network administrator about these settings.
- When using a wired LAN, connect the Ethernet cable (LAN cable) to the Ethernet/HDBaseT port (Ethernet port for MM models) on the projector. (→ page 169)

*TIP:* The network settings you make will not be affected even when [RESET] is done from the menu.

**Hints on How to Set Up LAN Connection****To set up the projector for a LAN connection:**

Select [WIRED LAN] → [PROFILES] → [PROFILE 1] or [PROFILE 2].

Two settings can be set for wired LAN.

Next turn on or off for [DHCP], [IP ADDRESS], [SUBNET MASK], and [GATEWAY] and select [OK] and press the ENTER button. (→ page 123)

**To recall LAN settings stored in the profile number:**

Select [PROFILE 1] or [PROFILE 2] for wired LAN, and then select [OK] and press the ENTER button. (→ page 123)

**To connect a DHCP server:**

Turn on [DHCP] for wired LAN. Select [ON] and press the ENTER button. To specify IP address without using the DHCP server, turn off [DHCP]. (→ page 123)

**To receive lamp replacement time or error messages via e-mail:**

Select [ALERT MAIL], and set [SENDER'S ADDRESS], [SMTP SERVER NAME], and [RECIPIENT'S ADDRESS]. Last, select [OK] and press the ENTER button. (→ page 125)



WIRED LAN

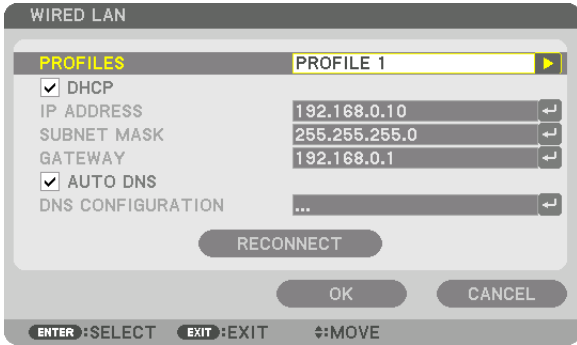

PROFILES	<ul style="list-style-type: none"> <li>The settings for using the built-in Ethernet/HDBaseT port in the projector can be recorded in the projector memory in two ways.</li> <li>Select [PROFILE 1] or [PROFILE 2] and then do settings for [DHCP] and the other options. After doing this, select [OK] and press the ENTER button. This will store your settings in memory.</li> <li>To recall the settings from memory: After selecting [PROFILE 1] or [PROFILE 2] from the [PROFILES] list. Select [OK] and press the ENTER button.</li> <li>Select [DISABLE] when not connecting to a wired LAN</li> </ul>	—
DHCP	Place a check mark to automatically assign an IP address to the projector from your DHCP server. Clear this check box to register the IP address or subnet mask number obtained from your network administrator.	—
IP ADDRESS	Set your IP address of the network connected to the projector when [DHCP] is turned off.	Up to 12 numeric characters
SUBNET MASK	Set your subnet mask number of the network connected to the projector when [DHCP] is turned off.	Up to 12 numeric characters
GATEWAY	Set the default gateway of the network connected to the projector when [DHCP] is turned off.	Up to 12 numeric characters
AUTO DNS	Place a check mark to automatically assign the IP address of your DNS server connected to the projector from your DHCP server. Clear this check box to set the IP address of your DNS server connected to the projector.	Up to 12 numeric characters
DNS CONFIGURATION	Set the IP address of your DNS server on the network connected to the projector when [AUTO DNS] is cleared.	Up to 12 numeric characters
RECONNECT	Retry to connect the projector to a network. Try this if you have changed [PROFILES].	—

**PROJECTOR NAME**

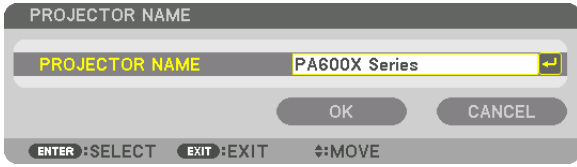

PROJECTOR NAME	Set a unique projector name.	Up to 16 alphanumeric characters and symbols
----------------	------------------------------	--

**DOMAIN**

Set a host name and domain name of the projector.

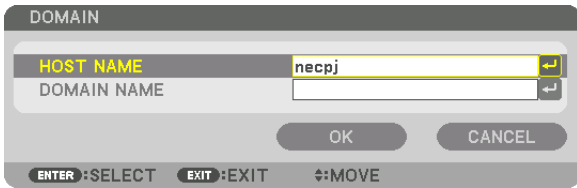

HOST NAME	Set a host name of the projector.	Up to 15 alphanumeric characters
DOMAIN NAME	Set a domain name of the projector.	Up to 60 alphanumeric characters

ALERT MAIL

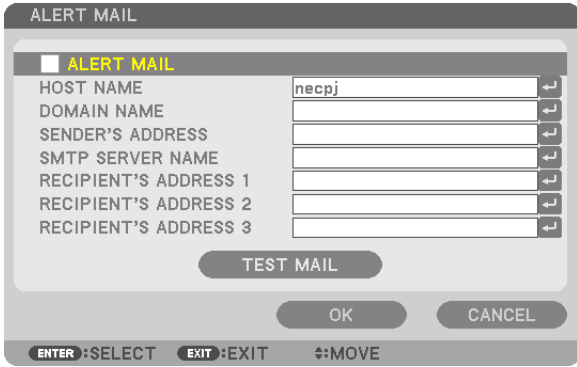

ALERT MAIL	<p>This option will notify your computer of lamp replace time or error messages via e-mail when using wireless or wired LAN.          Placing a checkmark will turn on the Alert Mail feature.          Clearing a checkmark will turn off the Alert Mail feature.</p> <p><b>Sample of a message to be sent from the projector:</b></p> <div style="border: 1px solid black; padding: 5px;"> <p>The lamp and filters are at the end of its usable life. Please replace the lamp and filters.              Projector Name: NEC Projector              Lamp Hours Used: 100 [H]</p> </div>	—
HOST NAME	Type in a host name.	Up to 15 alphanumeric characters
DOMAIN NAME	Type in a domain name of the network connected to the projector.	Up to 60 alphanumeric characters
SENDER'S ADDRESS	Specify the sender's address.	Up to 60 alphanumeric characters and symbols
SMTP SERVER NAME	Type in the SMTP server name to be connected to the projector.	Up to 60 alphanumeric characters
RECIPIENT'S ADDRESS 1, 2, 3	Type in your recipient's address.	Up to 60 alphanumeric characters and symbols
TEST MAIL	<p>Send a test mail to check if your settings are correct.</p> <p><i>NOTE:</i></p> <ul style="list-style-type: none"> <li>• If you entered an incorrect address in a test, you may not receive an Alert mail. Should this happen, check if the Recipient's Address is correctly set.</li> <li>• Unless any one of the [SENDER'S ADDRESS], [SMTP SERVER'S NAME] or [RECIPIENT'S ADDRESS 1-3] is selected, [TEST MAIL] is not available.</li> <li>• Be sure to highlight [OK] and press the ENTER button before executing [TEST MAIL].</li> </ul>	—

NETWORK SERVICE

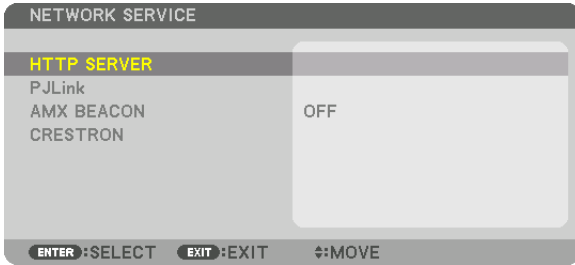

HTTP SERVER	Set a password for your HTTP server.	Up to 10 alphanumeric characters
PJLink	<p>This option allows you to set a password when you use the PJLink feature.</p> <hr/> <p><i>NOTE:</i></p> <ul style="list-style-type: none"> <li>• Do not forget your password. However, if you forget your password, consult with your dealer.</li> <li>• What is PJLink? PJLink is a standardization of protocol used for controlling projectors of different manufacturers. This standard protocol is established by Japan Business Machine and Information System Industries Association (JBMIA) in 2005. The projector supports all the commands of PJLink Class 1.</li> <li>• Setting of PJLink will not be affected even when [RESET] is done from the menu.</li> </ul>	Up to 32 alphanumeric characters
AMX BEACON	<p>Turn on or off for detection from AMX Device Discovery when connecting to the network supported by AMX's NetLinx control system.</p> <p><i>TIP:</i> When using a device that supports AMX Device Discovery, all AMX NetLinx control system will recognize the device and download the appropriate Device Discovery Module from an AMX server.</p> <p>Placing a checkmark will enable detecting the projector from AMX Device Discovery. Clearing a checkmark will disable detecting the projector from AMX Device Discovery.</p>	—
CRESTRON	<p>ROOMVIEW: Turn on or off when controlling the projector from your PC. CRESTRON CONTROL: Turn on or off when controlling the projector from your controller.</p> <ul style="list-style-type: none"> <li>• CONTROLLER IP ADDRESS: Enter your IP address of CRESTRON SERVER.</li> <li>• IP ID: Enter your IP ID of CRESTRON SERVER.</li> </ul>	Up to 12 numeric characters

**[SOURCE OPTIONS]**

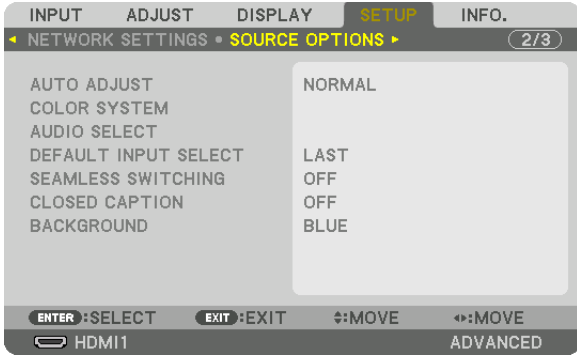

**Setting Auto Adjust [AUTO ADJUST]**

This feature sets the Auto Adjust mode so that the computer signal can be automatically or manually adjusted for noise and stability. You can automatically make adjustment in two ways: [NORMAL] and [FINE].

- OFF ..... The computer signal will not be automatically adjusted. You can manually optimize the computer signal.
- NORMAL..... Default setting. The computer signal will be automatically adjusted. Normally select this option.
- FINE..... Select this option if fine adjustment is needed. It takes more time to switch to the source than when [NORMAL] is selected.

*TIP:*

- The default setting when shipped from the factory is [NORMAL].
- When the AUTO ADJ. button is pressed, the same [FINE] adjustment is carried out.

**[COLOR SYSTEM]**

This feature allows you to select the TV video signal, which differs from country to country (NTSC, PAL, etc.). This is set to [AUTO] by factory default. Set this if the projector cannot identify the signal automatically.

**[AUDIO SELECT]**

This selects the audio input of the HDMI 1 IN terminal, HDMI 2 IN terminal, DisplayPort input terminal and Ethernet/HDBaseT port\*.

When inputting analog audio, connect the audio output terminal of the connecting device with the BNC audio input terminal and set the Audio Select to "BNC".

\* For MM models, use the HDMI 1 input terminal, HDMI 2 input terminal, DisplayPort input terminal, Ethernet port, USB-A port.

### Selecting Default Source [DEFAULT INPUT SELECT]

You can set the projector to default to any one of its inputs each time the projector is turned on.

LAST .....	Sets the projector to default to the previous or last active input each time the projector is turned on.
AUTO .....	Searches for an active source in order of HDMI1 → HDMI2 → DisplayPort → BNC → BNC(CV) → BNC(Y/C) → COMPUTER → HDBaseT and displays the first found source.
HDMI1 .....	Displays the digital source from the HDMI 1 IN connector every time the projector is turned on.
HDMI2 .....	Displays the digital source from the HDMI 2 IN connector every time the projector is turned on.
DisplayPort .....	Displays the digital source from the DisplayPort every time the projector is turned on.
BNC .....	Project the input signal from the BNC video input terminal
BNC(CV) .....	Project the input signal from the BNC(CV) video input terminal.
BNC(Y/C) .....	Project the input signal from the BNC(Y/C) video input terminal.
COMPUTER .....	Displays the computer signal from the COMPUTER IN connector every time the projector is turned on.
HDBaseT*1 .....	Project the HDBaseT signal.
ETHERNET*2 .....	Project the data sent from the computer via the wireless LAN unit (sold separately) that is fitted to the main body or the Ethernet port (RJ-45).
USB-A*2 .....	Project the data (viewer display) of the USB memory set up in the projector.

\*1 Only HDBaseT models will be displayed.

\*2 Only MM models will be displayed.

### [SEAMLESS SWITCHING]

When the input connector is switched, the image displayed before switching is held to switch to the new image without a break due to absence of a signal.

### Setting Closed Caption [CLOSED CAPTION]

This option sets several closed caption modes that allow text to be superimposed on the projected image of Video or S-Video.

The subtitles and text will be displayed a short while after the on-screen menu disappears.

OFF .....	This exits the closed caption mode.
CAPTION 1-4 .....	Text is superimposed.
TEXT 1-4 .....	Text is displayed.

### Selecting a Color or Logo for Background [BACKGROUND]

Use this feature to display a blue/black screen or logo when no signal is available. The default background is [BLUE].

---

#### NOTE:

- Even when the background logo is selected, if two pictures are displayed in [PIP/PICTURE BY PICTURE] mode, the blue background is displayed without the logo when there is no signal.
-

**[POWER OPTIONS]**

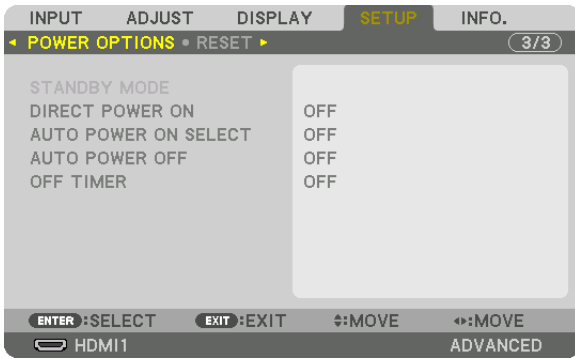

**Selecting Power-saving in [STANDBY MODE]**

Setting the power consumption in the standby mode.

**NORMAL**..... In the standby mode, the power consumption of the projector is 0.11 W (100-130 V)/0.16 W (200-240 V).

In the standby mode, the POWER indicator lights up in red while the STATUS indicator will go off.

- When set to [NORMAL], the following terminals and functions will be disabled. HDMI output terminal, Audio output terminal, Ethernet/HDBaseT port (Ethernet port for MM models), USB-A port, LAN function, [ALERT MAIL] function

**HDBaseT STANDBY (HDBaseT Models)/NETWORK STANDBY (MM Models)**

..... Compared to [NORMAL], the power consumption in the standby mode is higher but power can be supplied to the projector using a wired LAN.

In the standby mode, the power indicator will light up in orange while the status indicator will be turned off.

*Important:*

- When [HDBaseT STANDBY] ([NETWORK STANDBY] for MM models) is selected, [AUTO POWER OFF] turns grey in colour and becomes disabled while [0:15] is selected compulsorily.
- When it is set to [HDBaseT STANDBY] ([NETWORK STANDBY] for MM models), under the following conditions, the [STANDBY MODE] setting is disabled and the unit will go into the sleep mode\*.
  - \* Sleep mode refers to the mode whereby the functional restrictions due to the [STANDBY MODE] setting are removed.
  - When [ENABLE] is selected under [NETWORK SERVICE] → [AMX BEACON]
  - When [NETWORK SERVICE] → [CRESTRON] → [CRESTRON CONTROL] → [ENABLE] is selected
  - When [CONTROL] → [REMOTE SENSOR] → [HDBaseT] is selected (only for HDBaseT models)
  - Signal being received from the HDBaseT transmission device (only for HDBaseT models)
- When [NORMAL] is selected, the [AUTO POWER ON SELECT] display turns grey in color and is disabled, and [OFF] is automatically selected.

*NOTE:*

[HDBaseT Models]

- When connecting to a HDBaseT transmission device sold commercially, if the transmission device is set to transmit remote control signals, the power consumption of the projector in the standby mode will increase.

*TIP:*

- Your setting will not be affected even when [RESET] is done from the menu.
- The power consumption in the standby mode will not be included in calculating CO<sub>2</sub> emission reduction.

**Enabling Direct Power On [DIRECT POWER ON]**

Turns the projector on automatically when the power cord is inserted into an active power outlet. This eliminates the need to always use the POWER button on the remote control or projector cabinet.

### Turning On the Projector by Detecting Input Signal [AUTO POWER ON SELECT]

Under the condition of [NETWORK STANDBY], otherwise under the condition of [HDBaseT STANDBY] if you use HD-BaseT model, the projector automatically detects and projects synchronizing signal input from the selected terminals among Computer, HDMI1/2, DisplayPort, and HDBaseT by this function.

OFF ..... AUTO POWER ON SELECT function becomes inactive.

HDMI1, HDMI2, DisplayPort, COMPUTER, HDBaseT\*

..... When the projector detects the computer signal input from the selected terminal, automatically it will be turned ON and will project the computer screen.

\* This is not indicated on MM models.

---

#### NOTE:

- If you want to activate this AUTO POWER ON SELECT function after powering OFF the projector, interrupt signal from input terminals or pull out the computer cable from the projector and wait for over 3 seconds and then input signal from the selected terminal. In case computer signal is continuously input to the projector, however the projector is turned OFF and is in the transition to NETWORK STANDBY mode, it will keep NETWORK STANDBY mode and will not be turned ON automatically. In addition, if signal from HDMI1/2, DisplayPort or HDBaseT is continuously input to the projector, the projector may be turned ON again automatically based on the setting of external devices even if the projector is turned OFF and in the condition of NETWORK STANDBY mode.
- This function is not activated either by component signal input from the computer screen input terminal or computer signal as Sync on Green and Composite Sync.

---

### Enabling Power Management [AUTO POWER OFF]

When this option is selected you can enable the projector to automatically turn off (at the selected time: 0:05, 0:10, 0:15, 0:20, 0:30, 1:00) if there is no signal received by any input or if no operation is performed.

---

#### NOTE:

- [AUTO POWER OFF] will not work when projecting signals from the Ethernet/HDBaseT port in HDBaseT models. [AUTO POWER OFF] works even when the viewer or network is being projected in MM models.
- When the [STANDBY MODE] is set to [HDBaseT STANDBY] ([NETWORK STANDBY] for MM models), [AUTO POWER OFF] will turn grey in color and [0:15] will be selected compulsorily.

---

### Using Off Timer [OFF TIMER]

1. Select your desired time between 30 minutes and 16 hours: OFF, 0:30, 1:00, 2:00, 4:00, 8:00, 12:00, 16:00.
2. Press the ENTER button on the remote control.
3. The remaining time starts counting down.
4. The projector will turn off after the countdown is complete.

---

#### NOTE:

- To cancel the preset time, set [OFF] for the preset time or turn off the power.
  - When the remaining time reaches 3 minutes before the projector is turned off, the [THE PROJECTOR WILL TURN OFF WITHIN 3 MINUTES] message will be displayed on the bottom of the screen.
-



### Returning to Factory Default [RESET]

The RESET feature allows you to change adjustments and settings to the factory preset for a (all) source (s) except the following:



#### [CURRENT SIGNAL]

Resets the adjustments for the current signal to the factory preset levels.

The items that can be reset are: [PRESET], [CONTRAST], [BRIGHTNESS], [COLOR], [HUE], [SHARPNESS], [ASPECT RATIO], [HORIZONTAL], [VERTICAL], [CLOCK], [PHASE], and [OVERSCAN].

#### [ALL DATA]

Reset all the adjustments and settings for all the signals to the factory preset.

All items can be reset **EXCEPT** [ENTRY LIST], [LANGUAGE], [BACKGROUND], [FILTER MESSAGE], [EDGE BLENDING], [MULTI SCREEN], [SCREEN TYPE], [GEOMETRIC CORRECTION], [REF. WHITE BALANCE], [STATIC CONVERGENCE], [ADMINISTRATOR MODE], [CONTROL PANEL LOCK], [SECURITY], [COMMUNICATION SPEED], [DATE AND TIME SETTINGS], [CONTROL ID], [STANDBY MODE], [FAN MODE], [LAMP LIFE REMAINING], [LAMP HOURS USED], [FILTER HOURS USED], [TOTAL CARBON SAVINGS], [WIRED LAN], and [WIRELESS LAN].

To reset the lamp usage time, see “Clearing Lamp Hour Meter [CLEAR LAMP HOURS]” below.

#### [ALL DATA (INCLUDING ENTRY LIST)]

Reset all the adjustments and settings for all the signals to the factory preset except [LANGUAGE], [BACKGROUND], [FILTER MESSAGE], [EDGE BLENDING], [MULTI SCREEN], [SCREEN TYPE], [GEOMETRIC CORRECTION], [REF. WHITE BALANCE], [STATIC CONVERGENCE], [ADMINISTRATOR MODE], [CONTROL PANEL LOCK], [SECURITY], [COMMUNICATION SPEED], [DATE AND TIME SETTINGS], [CONTROL ID], [STANDBY MODE], [FAN MODE], [LAMP LIFE REMAINING], [LAMP HOURS USED], [FILTER HOURS USED], [TOTAL CARBON SAVINGS], [WIRED LAN], and [WIRELESS LAN].

Also deletes all the signals in the [ENTRY LIST] and returns to the factory preset.

---

*NOTE: Locked signals in Entry List cannot be reset.*

---

### Clearing Lamp Hour Meter [CLEAR LAMP HOURS]

Resets the lamp clock back to zero. Selecting this option displays submenu for a confirmation. Select [YES] and press the ENTER button.

---

*NOTE:*

- Elapsed time of the lamp use will not be affected even when [RESET] is done from the menu.
  - Performing [CLEAR LAMP HOURS] will return the [LAMP ADJUST] in [LAMP MODE] to its default adjustments. When the projector is used for multi-screen projection, use [LAMP ADJUST] to adjust the brightness again.
-

### Clearing the Filter Usage Hours [CLEAR FILTER HOURS]

Resets the filter usage back to zero. Selecting this option displays submenu for a confirmation. Select [YES] and press the ENTER button.

The [OFF] item is selected for [FILTER MESSAGE] at the time of shipment. When [OFF] is selected, you do not need to clear the filter usage hour.

---

*NOTE: Elapsed time of the filter use will not be affected even when [RESET] is done from the menu.*

---

## 8 Menu Descriptions & Functions [INFO.]

Displays the status of the current signal and lamp usage. This item has nine pages. The information included is as follows:

*TIP: Pressing the HELP button on the remote control will show the [INFO.] menu items.*

### [USAGE TIME]



\* This screen belongs to a HDBaseT model.

The sub-menu tab in the [INFO.] display in MM models will become [USAGE TIME]/[SOURCE(1)]/[SOURCE(2)]/[WIRED LAN]/[VERSION(1)]/[VERSION(2)]/[OTHERS]/[CONDITIONS].

- [LAMP LIFE REMAINING] (%)\*
- [LAMP HOURS USED] (H)
- [FILTER HOURS USED] (H)
- [TOTAL CARBON SAVINGS] (kg-CO2)

\* The progress indicator shows the percentage of remaining bulb life.

The value informs you of the amount of lamp usage. When the remaining lamp time reaches 0, the LAMP LIFE REMAINING bar indicator changes from 0% to 100 Hours and starts counting down.

If the remaining lamp time reaches 0 hours, the projector will not turn on.

- The message to the effect that the lamp or the filters should be replaced will be displayed for one minute when the projector is turned on and when the POWER button on the projector or the remote control is pressed. To dismiss this message, press any button on the projector or the remote control.

Lamp life(H)		During portrait installation	Replacement lamp
ECO MODE			
NORMAL (OFF)	ECO (ON)	2000	NP26LP
3000	4000		

- [TOTAL CARBON SAVINGS]

This displays the estimated carbon saving information in kg. The carbon footprint factor in the carbon saving calculation is based on the OECD (2008 Edition). (→ page 32)

**[SOURCE(1)]**

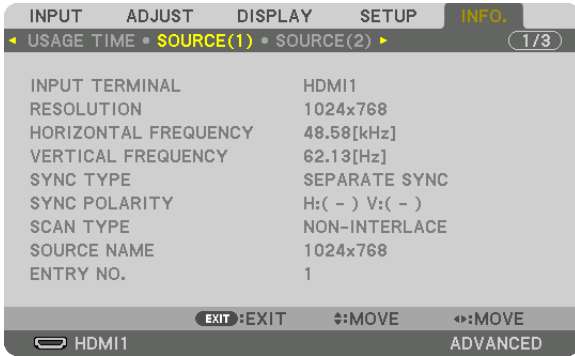

INPUT TERMINAL  
 HORIZONTAL FREQUENCY  
 SYNC TYPE  
 SCAN TYPE  
 ENTRY NO.

RESOLUTION  
 VERTICAL FREQUENCY  
 SYNC POLARITY  
 SOURCE NAME

**[SOURCE(2)]**



SIGNAL TYPE  
 BIT DEPTH  
 LINK RATE  
 3D FORMAT

VIDEO TYPE  
 VIDEO LEVEL  
 LINK LANE

**[SOURCE(3)]**

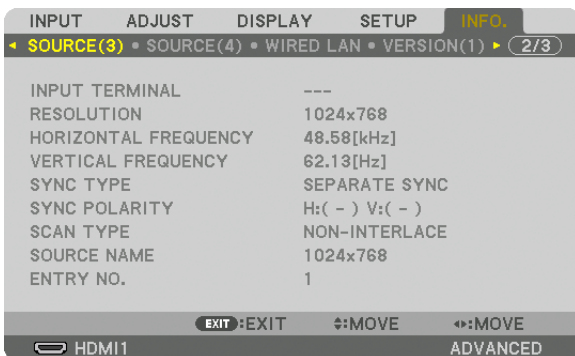

INPUT TERMINAL  
 HORIZONTAL FREQUENCY  
 SOURCE NAME

RESOLUTION  
 SYNC TYPE  
 ENTRY NO.

**[SOURCE(4)]**

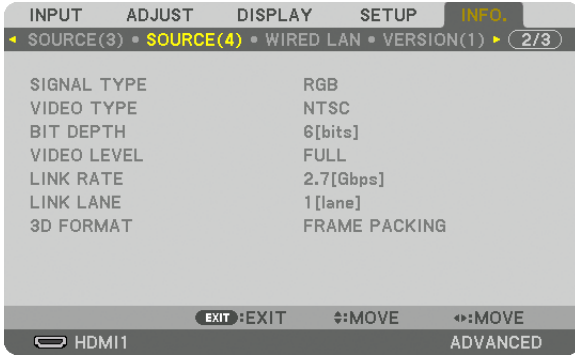

SIGNAL TYPE  
 BIT DEPTH  
 LINK RATE  
 3D FORMAT

VIDEO TYPE  
 VIDEO LEVEL  
 LINK LANE

**[WIRED LAN]**



IP ADDRESS  
 GATEWAY

SUBNET MASK  
 MAC ADDRESS

**[VERSION(1)]**



FIRMWARE  
 SUB-CPU

DATA

**[VERSION(2)] (MM only)**

FIRMWARE(MM)

**[OTHERS]**

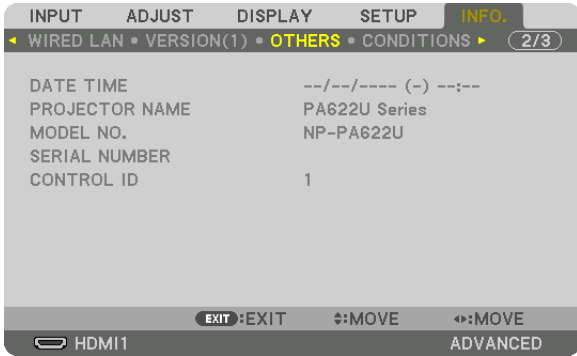

DATE TIME  
 MODEL NO.  
 CONTROL ID (when [CONTROL ID] is set)

PROJECTOR NAME  
 SERIAL NUMBER

**[CONDITIONS]**

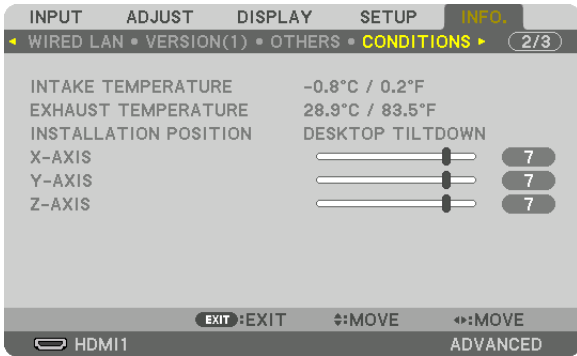

INTAKE TEMPERATURE  
 INSTALLATION POSITION  
 Y-AXIS

EXHAUST TEMPERATURE  
 X-AXIS  
 Z-AXIS

**About the X-AXIS, Y-AXIS and Z-AXIS CONDITIONS**

\* Arrow direction of the Z-AXIS in the figure represents the top of the projector.

X-AXIS ..... Display the projector image at an angle of -100 – +100 degrees to the horizontal in the X-axis direction.

X-AXIS value of the projector

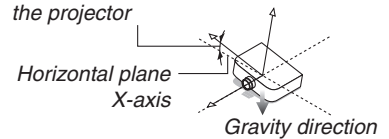

Y-AXIS ..... Display the projector image at an angle of -100 – +100 degrees to the horizontal in the Y-axis direction.

Y-AXIS value of the projector

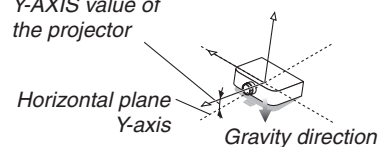

## 5. Using On-Screen Menu

Z-AXIS ..... Display the projector image at an angle of  $-100 - +100$  degrees to the vertical in the Z-axis direction.

Z-AXIS value of the projector

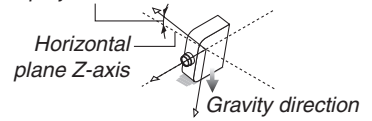

### [HDBaseT]

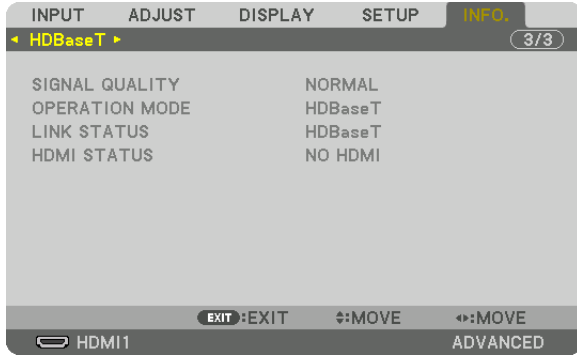

SIGNAL QUALITY  
LINK STATUS

OPERATION MODE  
HDMI STATUS

## 9 Application Menu (MM Models)

When [ETHERNET] is selected from the [INPUT] menu, the application menu [APPLICATION MENU] will be displayed.

The application menu allows you to set up the User Supportware and Network Settings (NETWORK SETTINGS). The User Supportware is contained on the supplied CD-ROM.

[ADVANCED] and [BASIC] can be selected in the [MENU MODE] under [SETUP] → [CONTROL] → [TOOLS] → [ADMINISTRATOR MODE]. (→ page 114)

The [BASIC] menu contains minimum essentials of menus and commands.



### IMAGE EXPRESS UTILITY

This shows information for projector name, resolution, and network (wired/wireless) which are required to use Image Express Utility.

Use this information to set up for your computer.

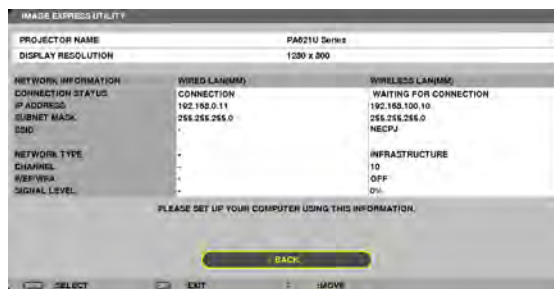

### DESKTOP CONTROL UTILITY

This allows you to set up for password entry/deletion, computer searching and IP address on network (wired/wireless) which are required to use Desktop Control Utility.

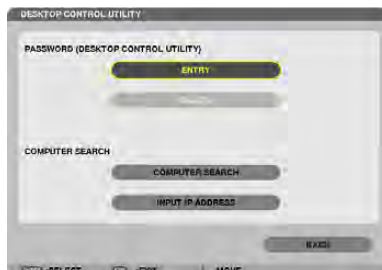



### NETWORK PROJECTOR

This shows information for projector name, resolution, and network (wired/wireless) which are required to use Network Projector.

Use this information to set up for your computer.



### REMOTE DESKTOP CONNECTION

This allows you to set up for computer name entry and effects for Remote Desktop.

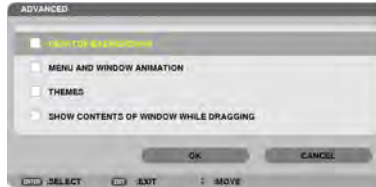
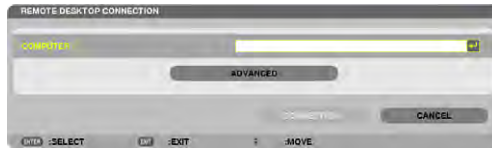

---

#### NOTE:

- A USB keyboard is required to set up the Remote Desktop Connection.
-

**NETWORK SETTINGS(MM)***Important:*

- Consult with your network administrator about these settings.
- When using a wired LAN, connect the LAN cable (Ethernet cable) to the Ethernet port (LAN) of the projector. (→ page 169)
- When using a wireless LAN, attach the wireless LAN unit (NP02LM2) sold separately to the projector. (→ page 170)

*TIP:* The [NETWORK SETTINGS(MM)] you make will not be affected even when [RESET] is done from the menu.

**Hints on How to Set Up LAN Connection****To set up the projector for a LAN connection:**

Select [WIRED LAN] or [WIRELESS LAN] → [PROFILES] → [PROFILE 1] or [PROFILE 2].

Two settings can be set for wired or wireless LAN.

Next turn on or off for [DHCP], [IP ADDRESS], [SUBNET MASK], and [GATEWAY] and select [OK] and press the ENTER button. (→ page 142)

**To recall LAN settings stored in the profile number:**

Select [PROFILE 1] or [PROFILE 2] for wired or wireless LAN, and then select [OK] and press the ENTER button. (→ page 141)

**To connect a DHCP server:**

Turn on [DHCP] for wired or wireless LAN. Select [ON] and press the ENTER button. To specify IP address without using the DHCP server, turn off [DHCP]. (→ page 142)

**To set only for wireless LAN (NETWORK TYPE and WEP/WPA):**

Select [PROFILE 1] or [PROFILE 2] for wireless LAN, and then select [ADVANCED] and [OK] and press the ENTER button. The Advanced menu will be displayed. (→ page 143)

**To select an SSID:**

Select [ADVANCED] → [SITE SURVEY] and press the ENTER button.

Select an SSID and press the > button to select [OK] and press the ENTER button.

If you do not use [SITE SURVEY], type the SSID and select [INFRASTRUCTURE] or [AD HOC]. (→ page 143)

**To execute [EASY CONNECTION] using Image Express Utility 2.0:**

The [EASY CONNECTION] is a mode that can abbreviate the troublesome LAN settings when using the Image Express Utility and connecting the PC and projector via a wireless LAN.

The Image Express Utility Lite and Image Express Utility 2.0 are contained on the supplied Projector CD-ROM.

To use [EASY CONNECTION], select [WIRELESS LAN] → [PROFILES] → [EASY CONNECTION].

*NOTE:* The [EASY CONNECTION] function is available on Windows 7, Windows Vista or Windows XP SP3.

WIRED LAN or WIRELESS LAN (ADVANCED menu only)



<p>PROFILES</p>	<ul style="list-style-type: none"> <li>• Up to two settings for the Ethernet port or USB wireless LAN unit can be stored in memory of the projector. Total of four settings can be stored. Five settings can be stored: two for the built-in Ethernet port, two for wireless LAN and one for WPS.</li> <li>• Select [PROFILE 1] or [PROFILE 2] and then do settings for [DHCP] and the other options. After doing this, select [OK] and press the ENTER button. This will store your settings in memory.</li> <li>• To recall the settings from memory: After selecting [PROFILE 1] or [PROFILE 2] from the [PROFILES] list. Select [OK] and press the ENTER button.</li> <li>• To execute [EASY CONNECTION] using Image Express Utility Lite or Image Express Utility 2.0, select [WIRELESS LAN] → [PROFILES] → [EASY CONNECTION].</li> <li>• To stop emitting radio waves from the USB Wireless LAN Unit, select [DISABLE] from the [PROFILES] list.</li> <li>• Selecting [SIMPLE ACCESS POINT] will allow the projector to create an infrastructure network. The IP address of the projector will be set automatically. Select "Obtain an IP Address Automatically" to set the IP address of a connected computer. It takes a few seconds for a change of your computer's IP address to come into effect in Windows 7/Windows Vista while it takes one or two minutes in Window XP. When you connect with your computer to save your profile and select "Automatically connect when within range" from the Properties tab of Wireless Network in Windows for your selected profile, your wireless LAN will be accessed under the following conditions: <ul style="list-style-type: none"> <li>• at the time of turning on the computer or the projector</li> <li>• when the notebook type is within the range of the projector's wireless LAN can be achieved.</li> </ul> Data transmission between wireless LAN and wired LAN is not possible. When the [SIMPLE ACCESS POINT] mode is used to send images, it is recommended to connect to only one computer. </li> </ul>	<p>—</p>
-----------------	---	----------

## 5. Using On-Screen Menu

	<ul style="list-style-type: none"> <li>When selecting [WPS], the network will be connected by using settings stored automatically with the WPS function. Selecting [WPS] will allow the projector to access the network by using the settings the WPS function automatically stored.</li> </ul>	
DHCP	Place a check mark to automatically assign an IP address to the projector from your DHCP server. Clear this check box to register the IP address or subnet mask number obtained from your network administrator.	—
IP ADDRESS	Set your IP address of the network connected to the projector when [DHCP] is turned off.	Up to 12 numeric characters
SUBNET MASK	Set your subnet mask number of the network connected to the projector when [DHCP] is turned off.	Up to 12 numeric characters
GATEWAY	Set the default gateway of the network connected to the projector when [DHCP] is turned off.	Up to 12 numeric characters
WNS CONFIGURATION	Set the IP address of your WINS server of the network connected to the projector when [DHCP] is turned off.	Up to 12 numeric characters
AUTO DNS	Place a check mark to automatically assign the IP address of your DNS server connected to the projector from your DHCP server. Clear this check box to set the IP address of your DNS server connected to the projector.	—
DNS CONFIGURATION	Set the IP address of your DNS server on the network connected to the projector when [AUTO DNS] is cleared.	Up to 12 numeric characters
ADVANCED*	This menu allows you to set various items for your wireless LAN connection (network type, security).	—
RECONNECT	Retry to connect the projector to a network. Try this if you have changed [PROFILES].	—



\* The [ADVANCED] setting screen is available for [WIRELESS LAN] only.

### NOTE:

- If you select [EASY CONNECTION] from [PROFILES], you cannot make settings to DHCP and its following items except [CHANNEL] in [ADVANCED].

### ADVANCED Setting (required for wireless LAN only) (ADVANCED menu only)



SITE SURVEY	<p>Displays a list of available SSIDs for wireless LAN on site. Select an SSID which you can access. To select an SSID, highlight [SSID] and use the SELECT → to select [OK] and press the ENTER button.</p> <p>  ..... Wireless access point   ..... Ad Hoc PC   ..... WEP or WPA enabled         </p>	—
SECURITY	<p>This will turn on or off the encryption mode for secure transmission. To use encryption, specify a WEP key or encryption key. Select your security type appropriate for your computer and the wireless LAN unit.</p> <p>           DISABLE ..... Will not turn on the encryption feature. Your communications may be monitored by someone.            WEP(64bit) ..... Uses 64-bit datalength for secure transmission.            WEP(128bit) ..... Uses 128-bit datalength for secure transmission. This option will increase privacy and security when compared to use of 64-bit datalength encryption.            WPA-PSK/WPA2-PSK/WPA-EAP/WPA2-EAP            ..... These options provide stronger security than WEP.         </p> <hr/> <p><i>NOTE:</i></p> <ul style="list-style-type: none"> <li>• The security type, WEP key, and encryption key settings must be the same as communication devices such as PC or access point in your wireless network.</li> <li>• When you use [SECURITY], your image transmission speed will slow down.</li> <li>• [WPA-PSK], [WPA-EAP], [WPA2-PSK] and [WPA2-EAP] are not available when [AD HOC] is selected from [NETWORK TYPE].</li> </ul>	—
SSID	Enter an identifier (SSID) for wireless LAN. Communication can be done only with equipment whose SSID matches SSID for your wireless LAN.	Up to 32 alphanumeric characters (case sensitive).
NETWORK TYPE	<p>Select communication method when using wireless LAN.</p> <p>           INFRASTRUCTURE ... Select this option when communicating with one or more equipment connected to the wireless or wired LAN network via a wireless access point.            AD HOC ..... Select this option when using the wireless LAN to directly communicate with a computer in peer-to-peer mode.         </p>	—
CHANNEL	Select a channel. Available channels vary depending on the country and region. When you select [INFRASTRUCTURE], make sure that the projector and your access point are on the same channel; when you select [AD HOC], make sure that the projector and your computer are on the same channel.	—

**When [WEP(64bit)] or [WEP(128bit)] is selected for [SECURITY TYPE]**

KEY SELECT	Selects one WEP key from the four keys below.		
KEY1, KEY2, KEY3, KEY4	Enter a WEP key.		
	• <b>Maximum number of characters</b>		
	Option	Alphanumeric (ASCII)	Hexadecimal (HEX)
	WEP 64bit	5	10
WEP 128bit	13	26	

**When [WPA-PSK], [WPA-EAP], [WPA2-PSK], or [WPA2-EAP] is selected for [SECURITY TYPE]**

ENCRYPTION TYPE	Select [TKIP] or [AES].
KEY	Enter encryption key. Key length must be 8 or greater and 63 or less.

### [AUTHENTICATION] (required for wireless only)

Setting is required for using WPA-EAP or WPA2-EAP.

#### Preparation before setting

Select a wireless LAN compliant WPA-EAP or WPA2-EAP authentication and install a digital certificate on the projector.

1. Set [DATE AND TIME] on the projector. (→ page 118)
2. Use a computer to save digital certificates (files) for WPA-EAP or WPA2-EAP setting to your USB memory device.

After completing saving the file, remove the USB memory device from the computer.

#### NOTE:

- Save a digital certificate (file) to the root folder of the USB memory.
- The file formats of digital certificate that are supported by the projector are DER and PKCS#12 only.
- The projector cannot handle any digital certificate whose file size exceeds 8 KB.
- CRL (Certificate Relocation List) is not supported.
- Client certificate chain is not supported.

3. Plug the USB memory device into the USB port of the projector.

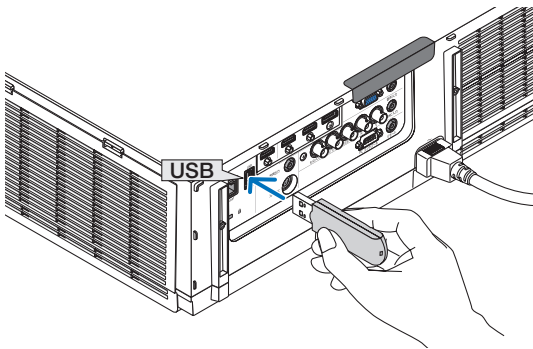

### Setting Procedures

1. Select [NETWORK SETTINGS(MM)] → [WIRELESS LAN].



2. Set items such as **PROFILES**, **DHCP**, **IP ADDRESS**, **SUBNET MASK** and others as required.
  - Select [PROFILE 1] or [PROFILE 2] for [PROFILES]. If [EASY CONNECTION] is selected, WPA-PSK, WPA2-PSK, WPA-EAP, or WPA2-EAP is not available.
3. Select [ADVANCED] and press the **ENTER** button.  
The [ADVANCED] setting screen will be displayed.

4. Select [SITE SURVEY] and press the ENTER button.



The "SSID" list will be displayed.

5. Select a connecting SSID, and then select [OK].



Finally press the ENTER button.

- Select the SSID for which WPA-PSK or WPA2-PSK is set.
- Select [INFRASTRUCTURE (📶)] for [NETWORK TYPE]. WPA-PSK, WPA2-PSK, WPA-EAP, or WPA2-EAP is not available when [AD HOC (📶)] is selected.

6. Select the [SECURITY] tab.

The [SECURITY] page will be displayed.

7. Select the [SECURITY TYPE] field and press the ENTER button.



The pull-down list will be displayed.

8. Select [WPA-EAP] or [WPA2-EAP] and press the ENTER button.

9. Select the [TKIP/AES] field and press the ENTER button.



The pull-down list will be displayed.

10. Select [TKIP] or [AES] and press the ENTER button.

Select [TKIP] or [AES] according to the setting for your access point.



11. Select the [AUTHENTICATION] tab.



The [AUTHENTICATION] page will be displayed.

Select either [EAP-TLS] or [PEAP-MSCHAPv2] for [EAP TYPE]. The setting items vary depending on the EAP type.

See the table below.

EAP Type	Setting Item	Note
EAP-TLS	User Name	1 character or more and 32 characters or less
	Client Certificate	PKCS#12 format file
	CA Certificate (Certificate authority's certificate)	DER format file
PEAP-MSCHAPv2	User Name	1 character or more and 32 characters or less
	Password	1 character or more and 32 characters or less
	CA Certificate (Certificate authority's certificate)	DER format file

① Selecting [EAP-TLS] for [EAP TYPE]:

The following section explains the operation for selecting [EAP-TLS].

For selecting [PEAP-MSCHAPv2], go on to Step 12 on page 149.

12. Select the [USER NAME] field and press the ENTER button.



The character entry screen (software keyboard) will be displayed. Set a user name.

- A user name must be 1 character or more and 32 characters or less.
- See page 148 for using the software keyboard to enter characters.

13. Select [CLIENT CERTIFICATE] and press the ENTER button.



A list of files ([FILES] screen) will be displayed.

- For operating the [FILES] screen, see “4. Using the Viewer” in the “User’s Manual” (PDF).
- To return to the [AUTHENTICATION] page, press the EXIT button.

NOTE:

**Installing a digital certificate**

You can install each digital certificate (client certificate and CA certificate) for [PROFILE 1 (or 2)] on a file-by-file basis.

- Install a root CA certificate for a CA certificate.
- If you install a digital certificate over your existing digital certificate, the existing digital certificate will be overwritten with the new digital certificate.
- Once a digital certificate has been installed, its information cannot be deleted even if you stop setting WPA-EAP or WPA2-EAP.

14. On the [FILES] screen, select a digital certificate (PKCS#12 format file) saved in your USB memory device and press the ENTER button.



The password screen will be displayed.

15. Select [PASSWORD] field and press the ENTER button.

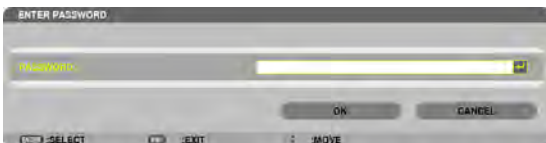

The character entry screen (software keyboard) will be displayed. Set the password of the private key. A password must be 1 character or more and 32 characters or less.

The selected digital certificate file will be installed on the projector.

- When the root CA certificate is not included in the file that was selected in Step 14, proceed to Step 16. When the root certification authority certificate is included, proceed to Step 18.

16. Select [CA CERTIFICATE] and press the ENTER button.

The drive list screen will be displayed.

17. On the [FILES] screen, select a digital certificate (DER format file) saved in your USB memory device and press the ENTER button.

- Select your root CA certificate here.

The selected digital certificate will be installed on the projector.

18. After completing required settings, select [OK] and press the ENTER button.

The [WIRELESS] page will be returned.

19. Select [RECONNECT] and press the ENTER button.

20. Select [OK] and press the ENTER button.

This will complete setting [EAP-TLS] for [EAP TYPE] in [WPA-EAP] or [WPA2-EAP].

TIP:

### Clearing the digital certificate that is installed on the projector

To clear the digital certificate installed on the projector, follow the steps below.

By doing the following procedure, all the digital certificates for the currently displayed profile will be cleared.

1. Select [CLEAR CERTIFICATES] in the bottom left of the [ADVANCED] setting screen and press the ENTER button.

A message for confirmation will be displayed.

2. Select [YES] and press the ENTER button.

The digital certificates will be cleared.



TIP:

- The PKCS#12 format digital certificate including a CA certificate will be installed as a root CA certificate.

### ② Selecting [PEAP-MSCHAPv2] for [EAP TYPE]:

12. From the [AUTHENTICATION] page, select [EAP TYPE] field and press the ENTER button.



The pull-down list will be displayed.

13. Select [PEAP-MSCHAPv2] and press the ENTER button.

14. Select [USER NAME] field and press the ENTER button.

The character entry screen (software keyboard) will be displayed. Set a user name.

- A user name must be 32 characters or less.

(→ page 147)

15. After completing setting a user name, select the [PASSWORD] field and press the ENTER button.



The character entry screen (software keyboard) will be displayed. Set a password.

- A password must be 32 characters or less.

16. After completing setting the password, select [CA CERTIFICATE] field and press the ENTER button.



The drive list screen will be displayed.

- For operating the [FILES] screen, see “4. Using the Viewer” in the “User’s Manual” (PDF).
- To return to the [AUTHENTICATION] page, press the EXIT button.

NOTE:

### Installing a digital certificate

You can install each digital certificate (client certificate and CA certificate) for [PROFILE 1 (or 2)] on a file-by-file basis.

- Install a root CA certificate for a CA certificate.
- If you install a digital certificate over your existing digital certificate, the existing digital certificate will be overwritten with the new digital certificate.
- Once a digital certificate has been installed, its information cannot be deleted even if you stop setting WPA-EAP or WPA2-EAP.

17. On the [FILES] screen, select a digital certificate (DER format file) saved in your USB memory device and press the ENTER button.



- Select your root CA certificate here.

The selected digital certificate will be installed on the projector.

18. After completing required settings, select [OK] and press the ENTER button.

The [WIRELESS] page will be returned.

19. Select [RECONNECT] and press the ENTER button.

20. Select [OK] and press the ENTER button.

This will complete setting [PEAP-MSCHAPv2] for [EAP TYPE] in [WPA-EAP] or [WPA2-EAP].

TIP:

### Clearing the digital certificate that is installed on the projector

To clear the digital certificate installed on the projector, follow the steps below.

By doing the following procedure, all the digital certificates for the currently displayed profile will be cleared.

1. Select [CLEAR CERTIFICATES] in the bottom left of the [ADVANCED] setting screen and press the ENTER button.

A message for confirmation will be displayed.

2. Select [YES] and press the ENTER button.

The digital certificates will be cleared.

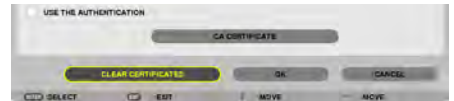

TIP:

### Entering WEP keys (Switching between Alphanumeric characters and hexadecimal)

To enter from [KEY1] to [KEY4], do the following:

1. Select one of [KEY 1], [KEY 2], [KEY 3] and [KEY 4] and press the ENTER button.

The character entry screen (software keyboard) will be displayed.



2. Use the ▼, ▲, ◀, or ▶ button to select a character and press the ENTER button.

- To enter a WEP key or passphrase, use alphanumeric characters (ASCII) or hexadecimal (HEX). To enter a PSK key, use alphanumeric characters (ASCII).
- Press the [HEX] button to change to [ASCII] to set the key in ASCII digit. You can toggle this button between [ASCII] and [HEX].
- Enter 0x(numeral and alphabet respectively) right in front of your key code.
- Hexadecimal uses 0 to 9 and A to F.

3. After entering your WEP key or passphrase, use the ▼, ▲, ◀, or ▶ button to select [OK] and press the ENTER button.

The character entry screen (software keyboard) will be closed.

### WPS(MM)

When the wireless LAN access point connected to the projector supports WPS (Wi-Fi Protected Setup™), you can use PIN method or push button method to set up the wireless LAN for the projector.



PIN TYPE	Set a 4-digit or 8 digit-PIN code of WPS for your access point to complete setting for the SSID security.
PUSH BUTTON TYPE	Press the dedicated button of the access point and the projector's wireless LAN unit to complete setting for the SSID security.

### NETWORK INFORMATION

The following information will be displayed when the projector is connected to a network (wired LAN or wireless LAN).



PROJECTOR NAME	
HOST NAME	
NETWORK INFORMATION (WIRED LAN/WIRELESS LAN)	CONNECTION STATUS, IP ADDRESS, SUBNET MASK, GATEWAY, WINS, DNS, MAC ADDRESS, SSID, NETWORK TYPE, WEP/WPA, CHANNEL, SIGNAL LEVEL, AUTHENTICATION, AUTHENTICATION PERIOD
DISPLAY THE INFORMATION IN APPLICATION MENU	Turn on or off the display of the network information.

The meanings of these status statements are described below.

Statement	Authentication status
Authenticated	Authentication is done correctly.
Failure	Authentication failed.
Authenticating...	Authentication is in process.
Expired	The digital certificate is expired. Or [DATE, TIME PRESET] is not set correctly.
Time Error	The [DATE, TIME PRESET] has been cleared. Set the correct date and time.

**HOST NAME (ADVANCED menu only)**

Setting up the host name (MM) of the projector.

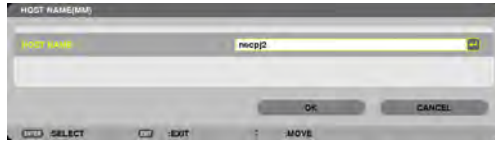

HOST NAME	Set a host name of the projector.	Up to 15 alphanumeric characters
-----------	-----------------------------------	----------------------------------

**HTTP SERVER (ADVANCED menu only)**

Password setting when using a HTTP server.



HTTP SERVER	Set a password for your HTTP server.	Up to 10 alphanumeric characters
-------------	--------------------------------------	----------------------------------



# 6. Connecting to Other Equipment

## ① Mounting a lens (sold separately)

Six separate bayonet style lenses can be used with this projector. The descriptions here are for the NP13ZL (2x zoom) lens. Mount other lenses in the same manner.

**NOTE:**

- The projector and lenses are made of precision parts. Do not subject them to shock or excessive forces.
- Remove the separately sold lens when moving the projector. If not, the lens could be subject to shock while the projector is being moved, damaging the lens and the lens shift mechanism.
- Turn off the power and wait for the cooling fan to stop before mounting or removing the lens.
- Never touch the lens surface while the projector is operating.
- Be very careful not to let dirt, grease, etc., on the lens surface and not to scratch the lens surface.
- Perform these operations on a flat surface over a piece of cloth, etc., to prevent the lens from getting scratched.
- When leaving the lens off the projector for long periods of time, mount the dust cap on the projector to prevent dust or dirt from getting inside.
- If you have multiple projectors, be careful of the following:
  - When mounting a lens designed exclusively for this projector onto another projector in the NP series, be sure to remove the lens attachment before mounting the lens on the projector. The lens cannot be mounted if its attachment is on. For the types of lenses that can be mounted and instructions on removing them, see the lense's operating instructions.
  - Other types of lenses cannot be mounted on this projector.

### Mounting the lens

**1. Remove the dust cap from the projector.**

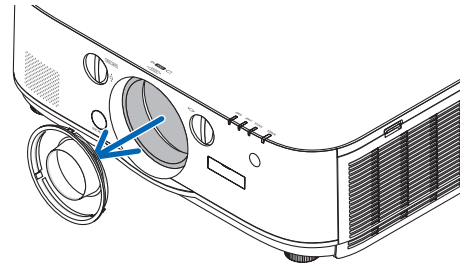

**2. Remove the lens cap on the back of the lens.**

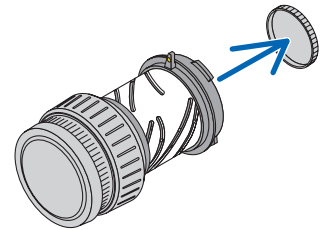

**3. Insert the lens onto the projector with the yellow-marked protrusion on the lens facing upwards.**

There is a positioning slit on the projector's lens insertion slot. Insert the lens slowly all the way in, keeping the positioning slit at the same angle.

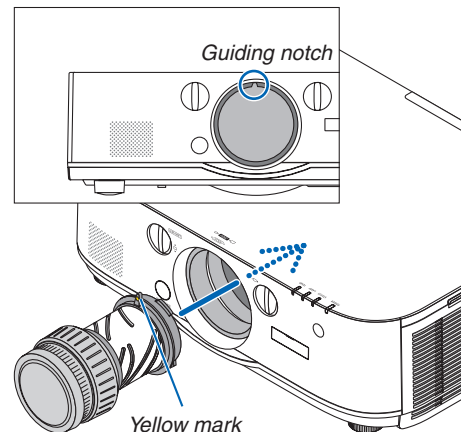

### 4. Turn the lens clockwise.

Turn until a click is heard.

The lens is now fastened onto the projector.

*TIP: Mounting the lens theft prevention screw*  
Fasten the lens theft prevention screw included with the projector to the bottom of the projector so that the lens cannot be removed easily.

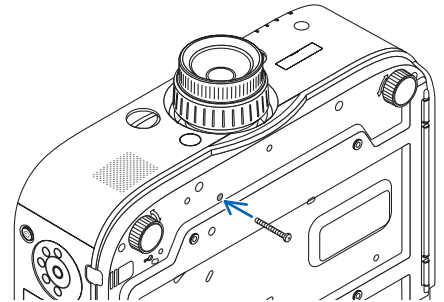
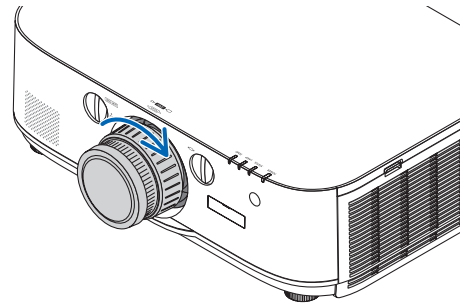

## Removing the lens

### 1. While pressing the lens release button on the projector's front panel fully in, turn the lens counterclockwise.

The lens comes off.

#### NOTE:

- Check the following areas if the lens unit cannot be removed even when the lens release button is pressed.
  1. Check whether the theft prevention screws of the lens unit have been installed.
  2. The lens release button may be locked sometimes. In that case, turn the lens fully to the right. The lens release button lock will be released.

### 2. Slowly pull the lens off the projector.

- After removing the lens, mount the lens caps (front and back) included with the lens before storing the lens.
- If no lens is going to be mounted on the projector, mount the dust cap included with the projector.

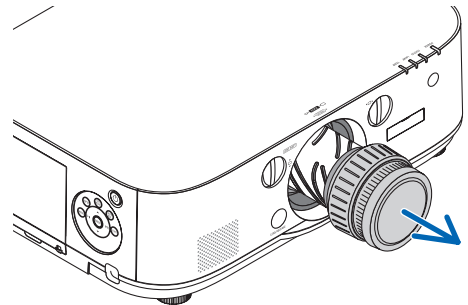
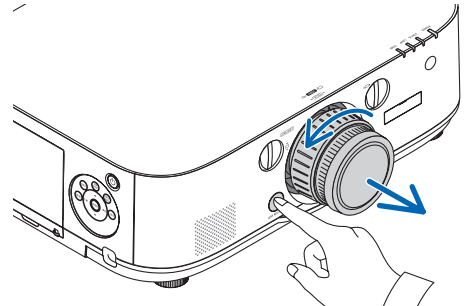

## ② Making Connections

A computer cable, BNC cable (5-core type), HDMI cable, or a DisplayPort cable can be used to connect to a computer.

The connection cable is not enclosed with the projector. Please get ready a suitable cable for the connection.

### Analog RGB signal connection

- Connect the computer cable to the display output terminal (mini D-sub 15 pin) on the computer and the computer video input terminal on the projector. Please use a computer cable attached with a ferrite core.
- When connecting the display output terminal (mini D-sub 15 pin) on the computer to the BNC video input terminal, use a conversion cable to convert the BNC cable (5 core) to a mini D-sub 15 pin cable.

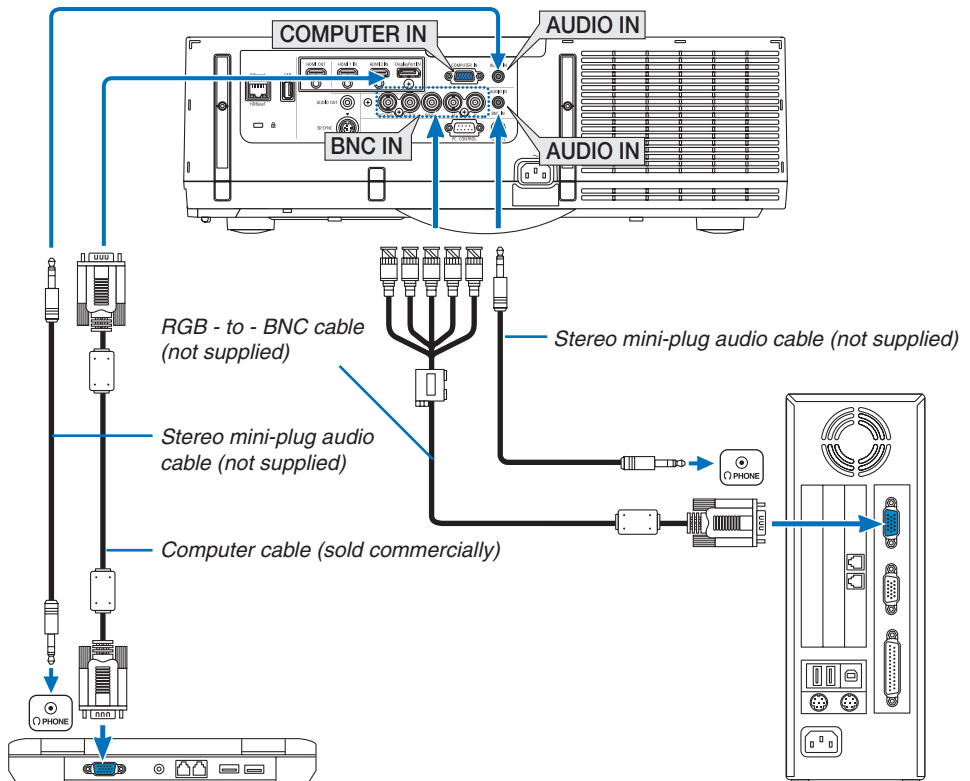

*NOTE: Please check the operating manual of the computer as the name, position and direction of the terminal may differ depending on the computer.*

- Select the source name for its appropriate input connector after turning on the projector.



Input connector	INPUT button on the projector cabinet	Button on the remote control
COMPUTER IN	7:COMPUTER	7/COMPUTER
BNC IN	x5 4:BNC	4/BNC

### Digital RGB signal connection

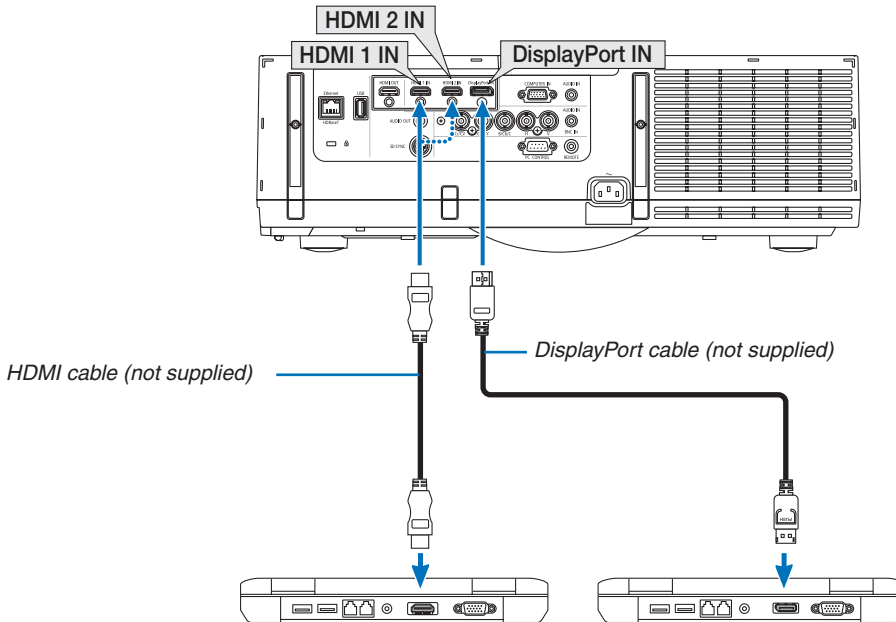
- Connect a commercially available HDMI cable between the computer's HDMI output connector and the projector's HDMI1 or HDMI2 input connector.
- Connect a commercially available DisplayPort cable between the computer's DisplayPort output connector and the projector's DisplayPort input connector.



- Select the source name for its appropriate input connector after turning on the projector.

Input connector	INPUT button on the projector cabinet	Button on the remote control
HDMI 1 IN	 1:HDMI 1	1/HDMI 1
HDMI 2 IN	 2:HDMI 2	2/HDMI 2
DisplayPort IN	 3:DisplayPort	3/DisplayPort

### Cautions when connecting an HDMI cable

- Use a certified High Speed HDMI® Cable or High Speed HDMI® Cable with Ethernet.

### Cautions when connecting a DisplayPort cable

- Use a certified DisplayPort cable.



- Depending on the computer, some time may be required until the image is displayed.
- Some DisplayPort cables (commercially available) have locks.
- To disconnect the cable, press the button on the top of the cable's connector, then pull the cable out.
- Power can be supplied to the connecting device from the Display Port input terminal (maximum of 1.65 W). However, power will not be supplied to the computer.
- When signals from a device that uses a signal converter adapter are connected to the DisplayPort input connector, in some cases the image may not be displayed.
- When the HDMI output of a computer is connected to the DisplayPort input connector, use a converter (commercially available).

### Cautions when using a DVI signal

- When the computer has a DVI output connector, use a commercially available converter cable to connect the computer to the projector's HDMI 1 or HDMI 2 input connector (only digital video signals can be input). Also, connect the computer's audio output to the projector's BNC audio input connector. In this case, switch the HDMI1 or HDMI2 setting at on-screen menu's audio selection on the projector to [BNC]. (→ page 127)

To connect the computer's DVI output connector to the projector's DisplayPort input connector, use a commercially available converter.

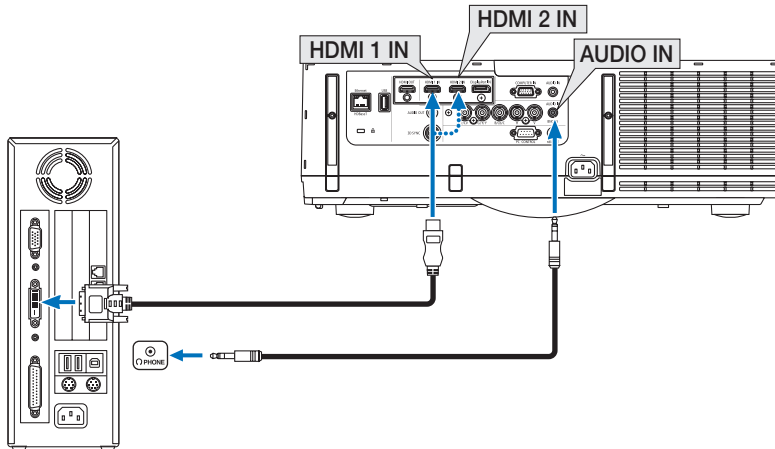

### NOTE: When Viewing a DVI Digital Signal

- Turn off the power of the computer and projector before connecting.
- Lower the computer's volume setting before connecting an audio cable to the headphones connector. When using with a computer connected to the projector, adjust the volume of both the projector and computer to set the appropriate volume level.
- If the computer has a mini-jack type audio output connector, we recommend connecting the audio cable to that connector.
- When a video deck is connected via a scan converter, etc., the display may not be correct during fast-forwarding and rewinding.
- Use a DVI-to-HDMI cable compliant with DDWG (Digital Display Working Group) DVI (Digital Visual Interface) revision 1.0 standard. The cable should be within 197"/5 m long.
- Turn off the projector and the PC before connecting the DVI-to-HDMI cable.
- To project a DVI digital signal: Connect the cables, turn the projector on, then select the HDMI input. Finally, turn on your PC. Failure to do so may not activate the digital output of the graphics card resulting in no picture being displayed. Should this happen, restart your PC.
- Some graphics cards have both analog RGB (15-pin D-Sub) and DVI (or DFP) outputs. Use of the 15-pin D-Sub connector may result in no picture being displayed from the digital output of the graphics card.
- Do not disconnect the DVI-to-HDMI cable while the projector is running. If the signal cable has been disconnected and then reconnected, an image may not be correctly displayed. Should this happen, restart your PC.
- The COMPUTER video input connectors support Windows Plug and Play. The BNC video input connector does not support Windows Plug and Play.
- A Mac signal adapter (commercially available) may be required to connect a Mac computer.  
To connect a Mac computer equipped with a Mini DisplayPort to the projector, use a commercially available Mini DisplayPort → DisplayPort converter cable.

### Connecting an External Monitor

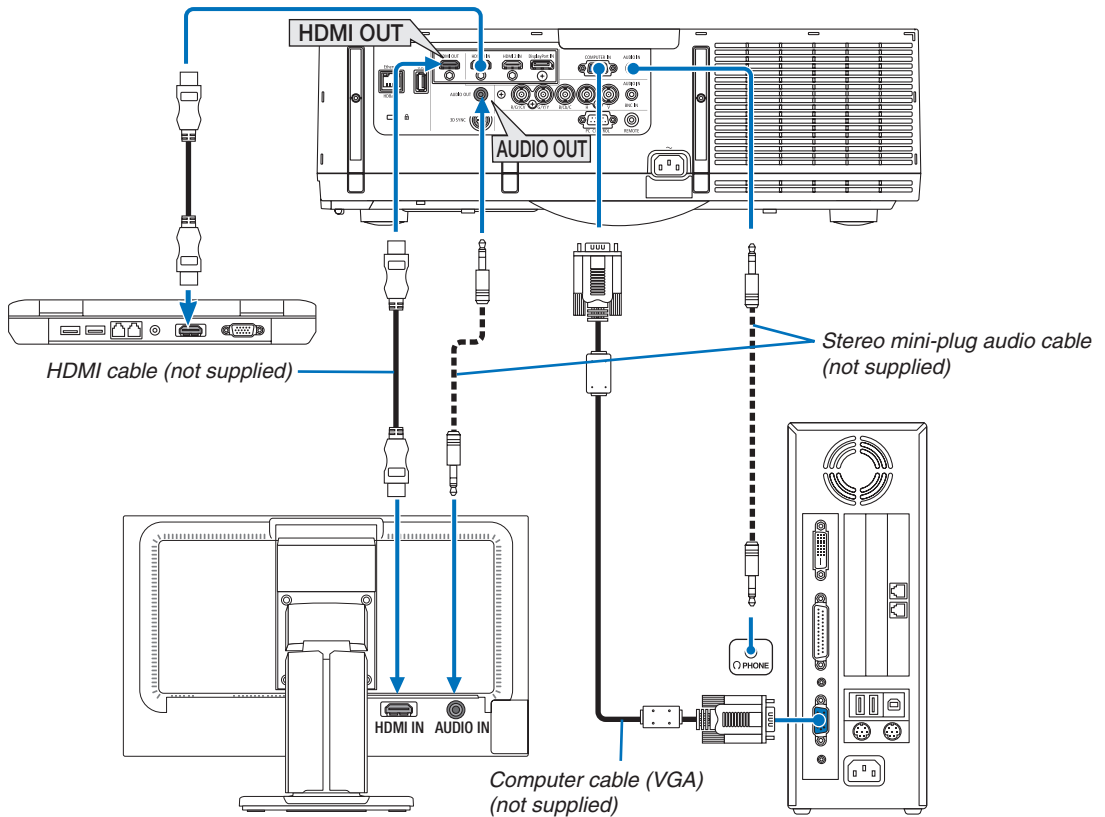

You can connect a separate, external monitor to your projector to simultaneously view on a monitor the computer analog image you're projecting.

- Please refer to Page 67 when displaying the [PIP/PICTURE BY PICTURE] screen.

#### NOTE:

- When outputting HDMI signals, turn on the power of the video device on the output side and keep it connected before inputting video signals into this device. The HDMI output terminals of the projector are equipped with repeater functions. When a device is connected to the HDMI output terminal, the resolution of the output signal is limited by the resolution supported by the connected device.
- Connecting and disconnecting an HDMI cable or selecting another input source on the second and subsequent projectors will disable the HDMI repeater function.
- In the case of the HDMI output terminal of the projector, the theoretical number of units that can be connected in a series is seven. The maximum number of units that can be connected may be reduced by the external environment and quality of the signal and cable, etc. The number of units that can be connected may differ depending on the HDCP version, restriction on the number of HDCP repeaters in the source device and the quality of the cable. The overall system needs to be checked in advance when building a system.
- When audio equipment is connected, the projector speaker is disabled.
- To output audio from the audio output terminal when the input terminal is neither "COMPUTER IN" nor "BNC IN", select [BNC] under [AUDIO SELECT] of the on-screen menu.
- When the [STANDBY MODE] is set to [NORMAL], video and audio will not be output when the projector is set to the standby mode. Set the standby mode to [NETWORK STANDBY] for MM models. For HDBaseT models, set the standby mode to [HDBaseT STANDBY], turn on the power supply to the transmission device and keep the unit in a connected state.
- For HDBaseT models, HDMI signals will not be output when the [STANDBY MODE] of the projector is set to [NORMAL]. To output a HDMI signal, set the [STANDBY MODE] to [HDBaseT STANDBY], turn on the power supply of the transmission device and keep the unit in a connected state.
- Both the composite video signal from each input connector as the computer, BNC, and BNC (CV), and the S-video signal from the BNC (Y/C) Input connector are not output from HDMI OUT Connector of this projector.

### Connecting Your Blu-ray Player or Other AV Equipment

Component video signal/S-video signal connection

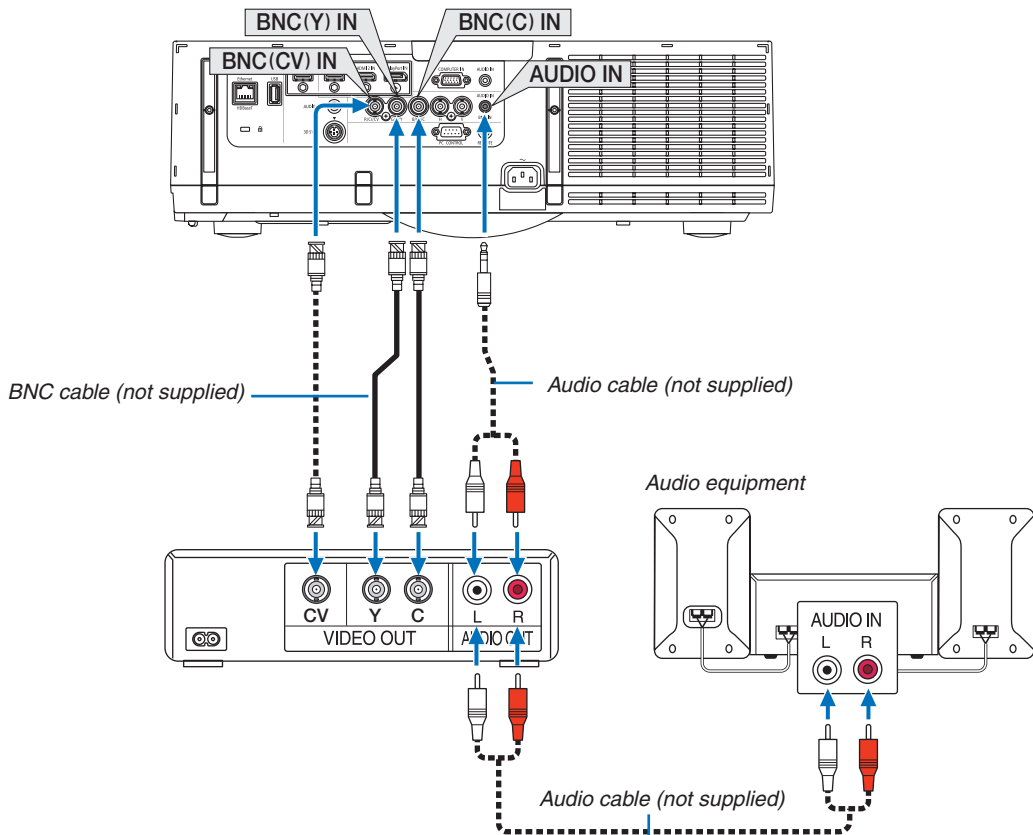

- Select the source name for its appropriate input connector after turning on the projector.

Input connector	INPUT button on the projector cabinet	Button on the remote control
BNC(CV) IN	●●● 5:BNC(CV)	5/BNC(CV)
BNC(Y/C) IN	●●● 6:BNC(Y/C)	6/BNC(Y/C)

**NOTE:**

- The BNC (analog RGB/component), BNC (CV) and BNC (Y/C) audio input terminals are shared.



### Connecting Component Input

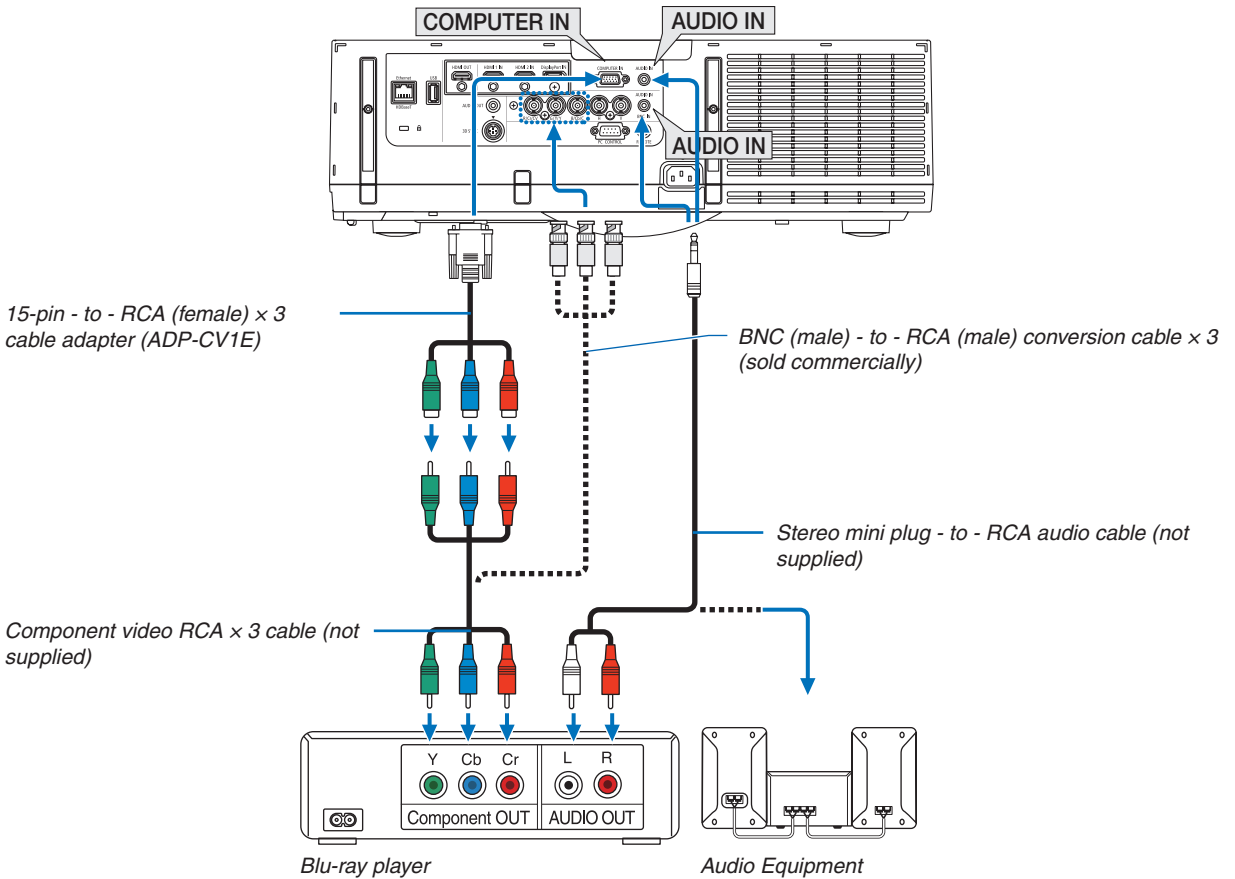

- Select the source name for its appropriate input connector after turning on the projector.

Input connector	INPUT button on the projector cabinet	Button on the remote control
COMPUTER IN	7:COMPUTER	7/COMPUTER
BNC IN	×5 4:BNC	4/BNC



#### NOTE:

- When the signal format is set to [AUTO] (default factory setting when shipped), the computer signal and component signal are automatically distinguished and switched. If the signals cannot be distinguished, select [COMPONENT] under [ADJUST] → [VIDEO] → [SIGNAL TYPE] in the on-screen menu of the projector.
- To connect to a video device with a D connector, use the sold separately D connector converter adapter (model ADP-DT1E).

### Connecting HDMI Input

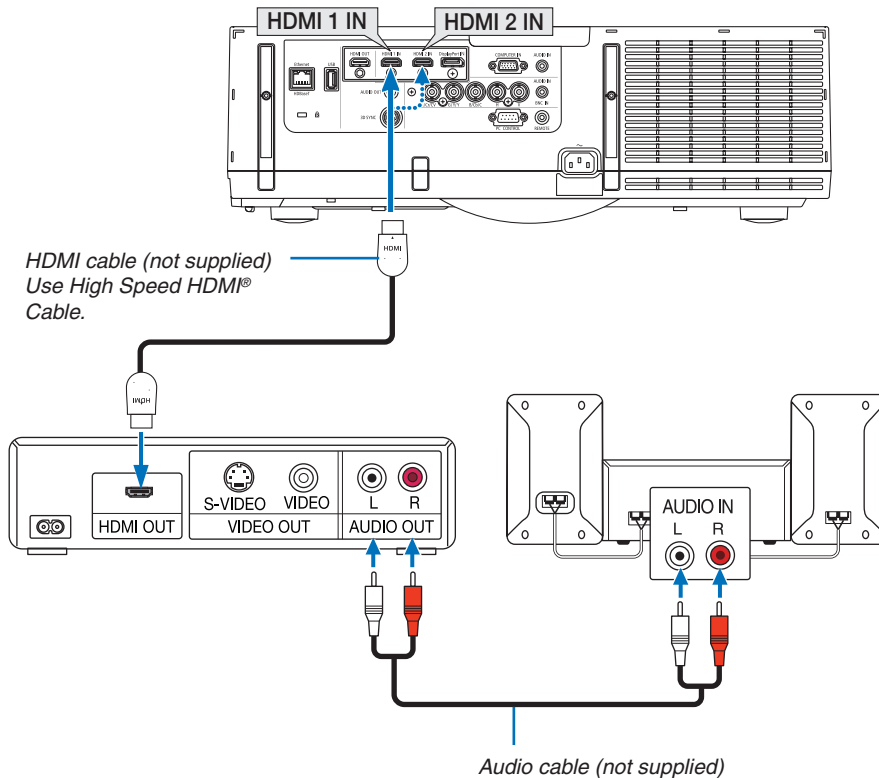
You can connect the HDMI output of your Blu-ray player, hard disk player, or notebook type PC to the HDMI 1 IN or HDMI 2 IN connector of your projector.



Input connector	INPUT button on the projector cabinet	Button on the remote control
HDMI 1 IN	 1:HDMI 1	1/HDMI 1
HDMI 2 IN	 2:HDMI 2	2/HDMI 2

*TIP: For users of audio video equipment with an HDMI connector:*

Select "Enhanced" rather than "Normal" if HDMI output is switchable between "Enhanced" and "Normal". This will provide improved image contrast and more detailed dark areas.

For more information on settings, refer to the instruction manual of the audio video equipment to be connected.

- When connecting the HDMI 1 IN or HDMI 2 IN connector of the projector to the Blu-ray player, the projector's video level can be made settings in accordance with the Blu-ray player's video level. In the menu select [ADJUST] → [VIDEO] → [VIDEO LEVEL] and make necessary settings.
- If the HDMI input sound cannot be heard, in the menu select [AUDIO SELECT] → [HDMI1] or [HDMI2].
- If the HDMI input's sound is not output, check that [SOURCE OPTIONS] → [AUDIO SELECT] → [HDMI1] or [HDMI2] on the projector's on-screen menu is set to "HDMI". (→ page 127)

## 6. Installation and Connections

### Connecting to a HDBaseT transmission device (sold commercially) (HDBaseT Models)

HDBaseT is a connection standard for home appliances that is established by the HDBaseT Alliance.

Use a LAN cable sold commercially to connect the Ethernet / HDBaseT port of the projector (RJ-45) to a HDBaseT transmission device sold commercially.

The Ethernet/HDBaseT port of the projector supports HDMI signals (HDCP) from transmission devices, control signals from external devices (serial, LAN) and remote control signals (IR commands).

- Refer to the owner's manual accompanied with your HDBaseT transmission for connecting with your external devices.

### Connection example

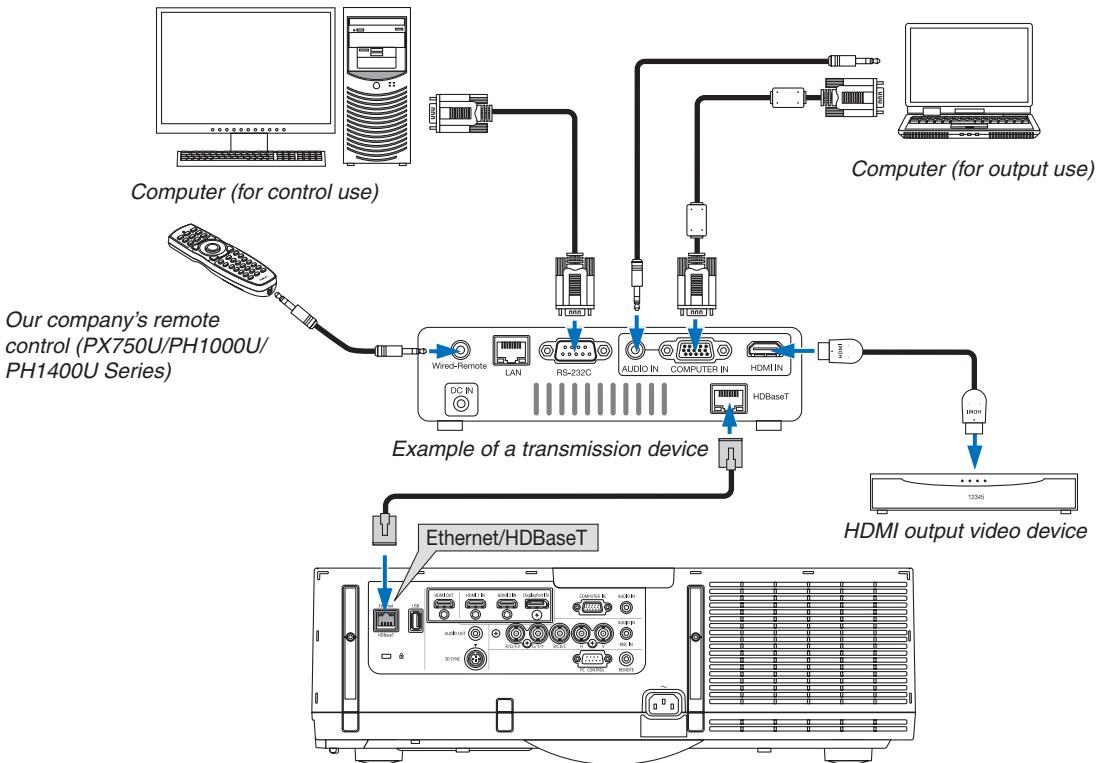

#### NOTE:

- Please use a shielded twisted pair (STP) cable of Category 5e or higher for the LAN cable (sold commercially).
- The maximum transmission distance over the LAN cable is 100 m. (the maximum distance is 70 m for a 4K signal)
- Please do not use other transmission equipment between the projector and transmission equipment. The picture quality may be degraded as a result.
- This projector is not guaranteed to work with all HDBaseT transmission devices sold commercially.

### Portrait projection (vertical orientation)

Portrait screens from a computer can be projected by installing the projector in a vertical orientation. All the screens such as the on-screen menu will be rotated in a counter-clockwise direction.

The projector is equipped with a sensor to automatically detect the installation state.

When the projector is installed in a portrait configuration for the first time with the lamp lit up, a caution message to indicate that the operating time of the lamp may be shortened will be displayed.

This message will automatically disappear when the installation state of the projector is returned to the original state.

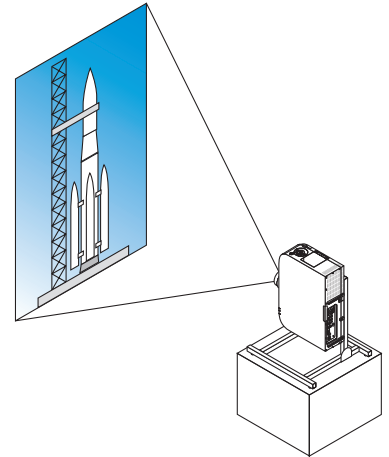

#### Precautions during installation

- Please do not install the projector in a vertical orientation on top of the floor or table on its own. The intake vent may be obstructed, resulting in the projector getting warm and the possibility of fire and malfunction occurring.
- For vertical installation, install the projector with the intake vent (filter) facing downwards. A stand for supporting the projector needs to be made for this purpose. In this case, the stand must be designed such that the center of gravity of the projector is located well within the legs of the stand. If not, the projector may fall over and result in injury, damage and malfunction.
- Do not use the lens shift function when performing portrait projection. Use the position of the lens shift mechanism in the center (lens center).

#### NOTE:

- *The lamp replacement time (as a guide)\* is about 2000 hours for portrait projection.*  
\* Replacement time is not guaranteed.
- *When installing in a portrait configuration for the first time, portrait projection cannot be used when the number of lamp hours used shown under [INFO.] → [USAGE TIME] → [LAMP HOURS USED] in the on-screen menu exceeds 1900 hours.*
- *When the [FAN MODE] is set to a mode other than [AUTO], portrait projection cannot be used.*

### Design and manufacturing conditions for the stand

Please engage an installation service provider for the design and manufacture of the customized stand to be used for portrait projection. Please ensure that the following are complied with when designing the stand.

1. Maintain an opening of at least 310 × 170 mm so as not to obstruct the intake vent / filter of the projector.
2. Maintain a distance of at least 130 mm between the projector intake vent and the floor (for the opening of the filter cover).
3. Use the four screw holes at the back of the projector to secure it to the stand.  
Screw hole center dimension: 200 × 250 mm  
Screw hole dimension on the projector: M4 with a maximum depth of 8 mm.
  - \* Please design the stand such that the rear legs at the back of the projector do not contact the stand. The front legs can be turned and removed.
4. Horizontal adjustment mechanism (for example, bolts and nuts in four locations)
5. Please design the stand such that it does not topple over easily.

### Reference drawings

\* The drawing showing the dimensional requirements is not an actual stand design drawing.

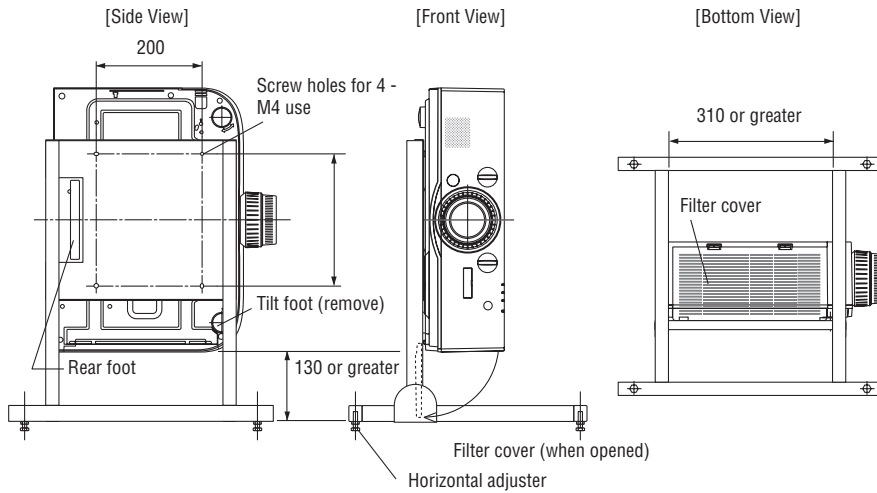

### Lens shift securing method

#### 1. Pull the securing lever cover towards you to remove it.

- The cover cannot be detached from the projector.

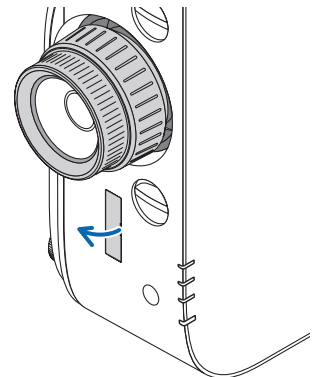

#### 2. Turn the screws to the left to loosen them.

- Screws cannot be removed.

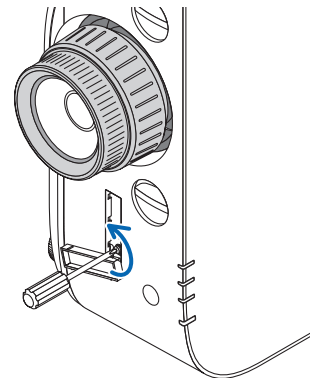

## 6. Installation and Connections

**3. Slide the securing lever towards the top until it comes to a stop and then turn the screws to the right to tighten them.**

- Tighten the screws while pressing the securing lever towards the top.
- \* Loosen the screws first before re-adjusting the lens shift.

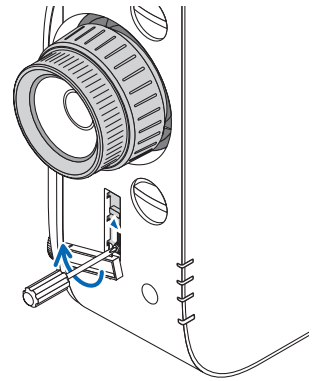

**4. Fix the four securing lever covers.**

---

**NOTE:**

- Determine the screen position first before using the securing levers.
  - Do not turn the zoom ring when using the securing lever. Please do not remove the lens either.
  - The securing lever is used to support the lens and not to secure the lens. As a result, the screen may shift when the lens is touched.
-

### Connecting to a Wired LAN

The projector comes standard with an Ethernet/HDBaseT port (RJ-45) which provides a LAN connection using a LAN cable.

To use a LAN connection, you are required to set the LAN on the projector menu. Select [SETUP] → [NETWORK SETTINGS] → [WIRED LAN]. (→ page 123).

### Example of LAN connection

Example of wired LAN connection

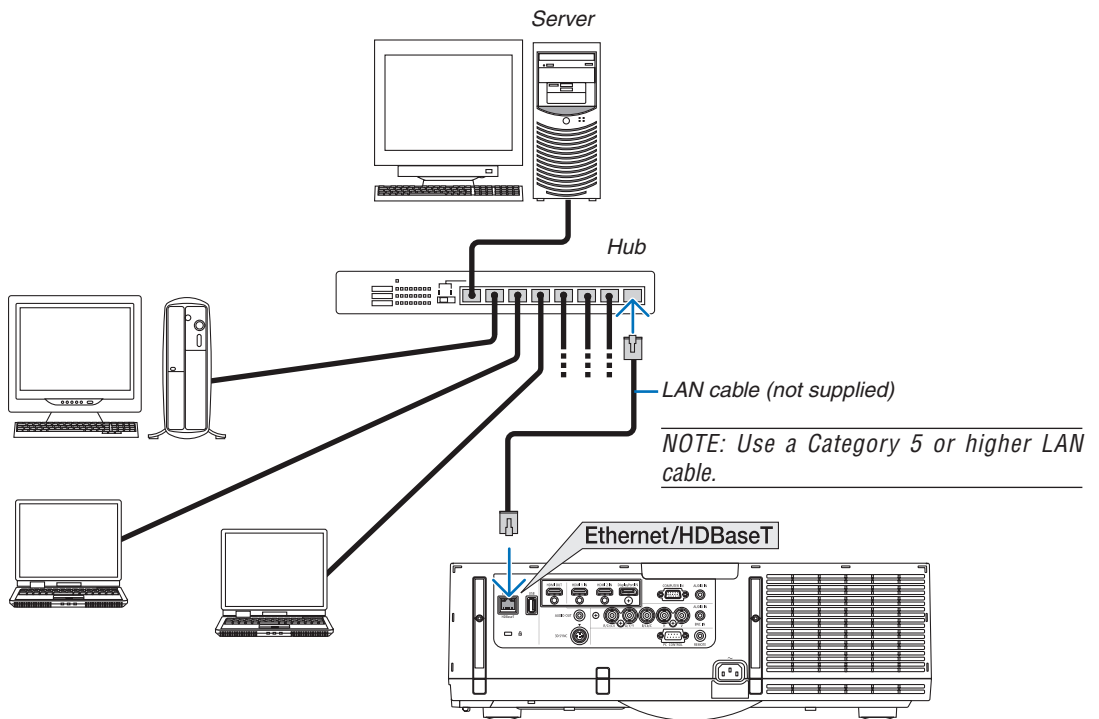

### Connecting to a Wireless LAN (sold separately) (MM Models)

The separately sold wireless LAN unit allows you to use a wireless LAN environment. When using the projector in a wireless LAN environment, the IP address and other settings must be made on the projector.

#### Important:

- If you use the projector with the USB Wireless LAN Unit in the area where the use of wireless LAN equipment is prohibited, remove the USB Wireless LAN Unit from the projector.
- Buy the appropriate USB Wireless LAN Unit for your country or area.

---

#### NOTE:

- The green LED on the USB Wireless LAN Unit flashes to show that the USB Wireless LAN Unit is working.
  - Your computer's wireless LAN adapter (or unit) must be complied with Wi-Fi (IEEE802.11b/g/n) standard.
- 

### Flow of Setting Wireless LAN

**Step 1:** Attach the USB Wireless LAN Unit to the projector if required.

**Step 2:** Display [NETWORK SETTINGS(MM)] from [APPLICATION MENU]. (→ page 140)

**Step 3:** Select [NETWORK SETTINGS(MM)] → [WIRELESS LAN] → [PROFILES] and set [EASY CONNECTION], [PROFILE 1], or [PROFILE 2]. (→ page 141)

#### TIP:

Access the HTTP server function to set [NETWORK SETTINGS] → [SETTINGS] → [WIRELESS] → [EASY CONNECTION], [PROFILE1], [PROFILE2].

### Mounting a wireless LAN unit

#### CAUTION:

- The wireless LAN unit is mounted inside the projector. Before mounting it, turn off the power, unplug the power cord and let the projector cool down completely. Removing the filter unit while the projector is running could result in burns or electric shocks from touching internal parts.

---

#### NOTE:

- The wireless LAN unit has a front and a back and must be mounted in the wireless LAN port in a specific direction. The port is designed so that the unit cannot be mounted in the opposite direction, but trying to push it in by force could damage the wireless LAN unit port.
  - To prevent damage due to static electricity, touch a nearby metal object (a door knob, aluminum sash, etc.) before touching the wireless LAN unit to eliminate the static electricity from your body.
  - Disconnect the power cord when mounting and removing the wireless LAN unit.  
Mounting and removing the wireless LAN unit while the projector's power is on could damage the wireless LAN unit or result in malfunction on the projector. If the projector should malfunction, turn off the projector's power, unplug the power cord, then plug the power cord back in.
  - Do not attach USB devices other than the wireless LAN unit to the USB (LAN) port inside the main body. Do not attach the wireless LAN unit to the USB-A port at the terminal unit as well.
-



## 6. Installation and Connections

1. Press the  button to set the projector to the standby mode, then disconnect the power cord.

Wait for the projector to fully cool off.

2. Press down on the buttons on the left and right and then pull the filter cover towards you to open it.

The cover will open about 90 degrees before it stops.

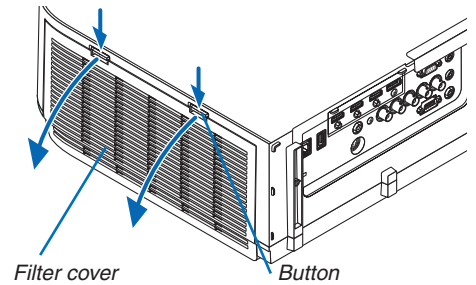

3. Remove the filter unit by pulling out the tab.

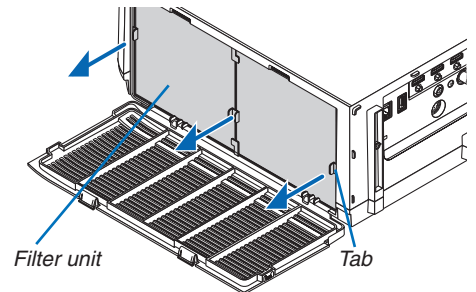

4. Slowly insert the wireless LAN unit into the USB (LAN) port.

- Remove the wireless LAN unit's cap, set the unit with the front (the side with the indicator) facing upwards, hold the back edge and insert the unit gently.

Next, press the wireless LAN unit in with a finger.

- The cap you have removed will be used when the wireless LAN unit is removed, so store it in a safe place.

**NOTE:** If the wireless LAN unit is hard to insert, do not push it in by force.

Wireless LAN unit

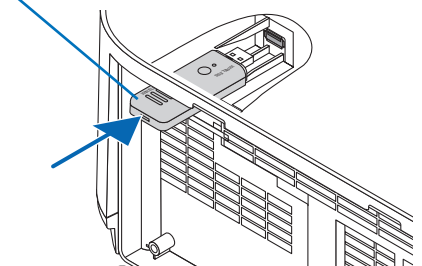

5. Mount the filter unit back onto the projector cabinet.

Insert the filter unit onto the projector with the sides on which the left and right hooks are located on the outside.

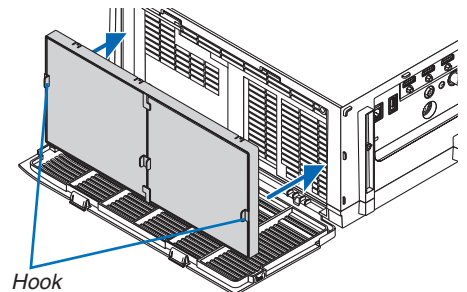

## 6. Installation and Connections

### 6. Close the filter cover.

After closing, push the filter cover near the buttons until a “click” sound is heard. The filter cover will be secured in position.

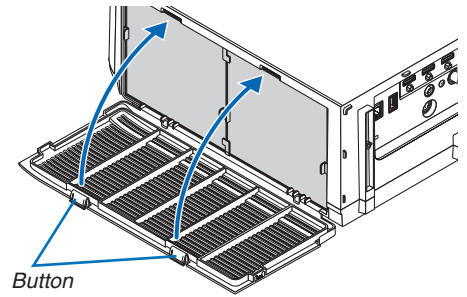

### To remove the wireless LAN unit

#### 1. Remove the filter unit following steps 1 to 3 above.

#### 2. Remove the wireless LAN unit.

If the wireless LAN unit is hard to remove, place a cloth, etc., over needle-nose pliers to grasp the wireless LAN unit and pull it out.

*NOTE: Do not grasp the wireless LAN unit with excessive force. Doing so will damage it.*

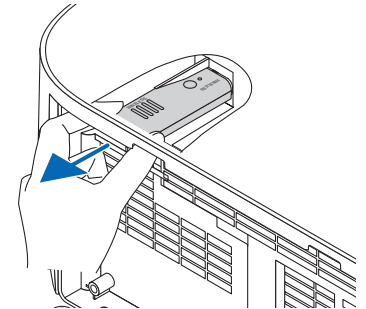

#### 3. Mount the filter unit and filter cover as described in steps 5 and 6 above.

**Example of wireless LAN connection**

(Network Type → Infrastructure)

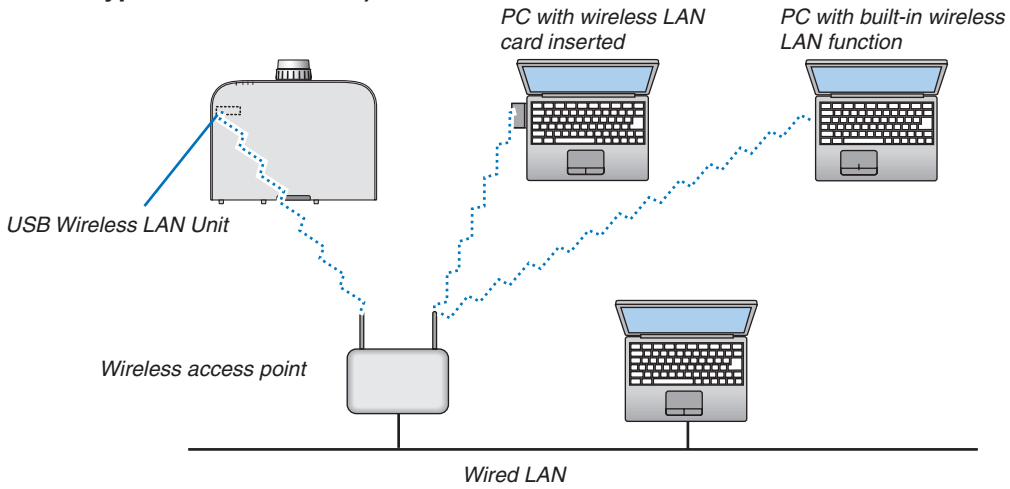

(Network Type → Ad Hoc)

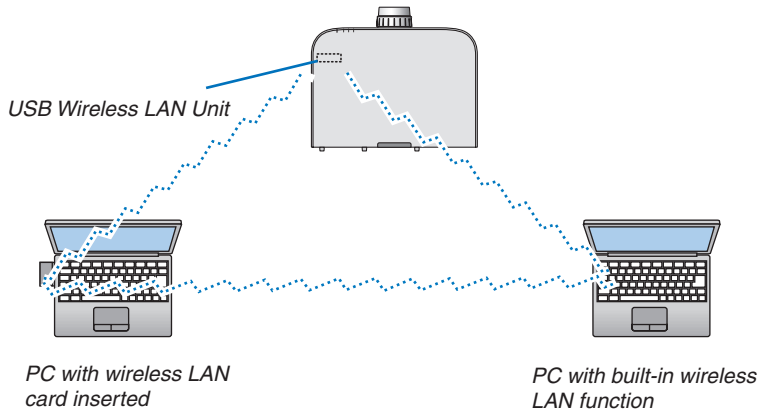

To enable direct communication (i.e., peer-to-peer) between personal computers and projectors, you need to select the Ad Hoc mode.

# 7. Maintenance

This section describes the simple maintenance procedures you should follow to clean the filters, the lens, the cabinet, and to replace the lamp and the filters.

## 1 Cleaning the Filters

The air-filter sponge keeps dust and dirt from getting inside the projector and should be frequently cleaned. If the filter is dirty or clogged, your projector may overheat.

### WARNING

- Please do not use a spray containing flammable gas to remove dust attached to the filters, etc. Doing so may result in fires.

*NOTE: The message for filter cleaning will be displayed for one minute after the projector is turned on or off. When the message is displayed, clean the filters. The time to clean the filters is set to [OFF] at time of shipment. (→ page 110)*

*To cancel the message, press any button on the projector cabinet or the remote control.*

The two-layer filter on the projector improves cooling and dust-proof capabilities compared with the conventional models.

The outsides (the intake vent side) of the first and second layer filters remove dust.

To clean the filter, detach the filter unit and the filter cover.

### CAUTION

- Before cleaning the filters, turn off the projector, disconnect the power cord and then allow the cabinet to cool. Failure to do so can result in electric shock or burn injuries.

#### 1. Press down on the buttons on the left and right and then pull the filter cover towards you to open it.

*The cover will open about 90 degrees before it stops.*

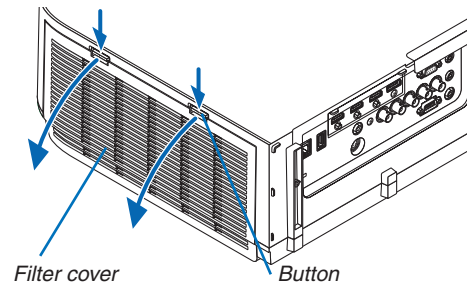

#### **When mounting the projector to a ceiling**

*The filter cover will open about 90 degrees before it comes to a stop at the stopper position. Remove your hands as the stopper will be detached if it is opened further. The filter cover will stop at a position of about 90 degrees.*

*However, the filter cover may close if the projector vibrates.*

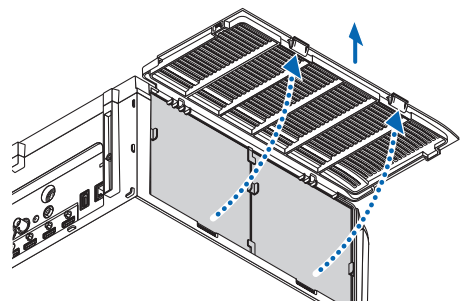

**2. Remove the filter unit by pulling out the tab.**

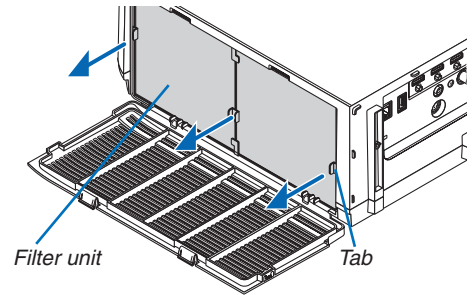

**3. Remove the four filters.**

Hold and remove the filters fitted to the two sides of the filter unit.

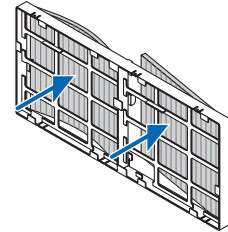
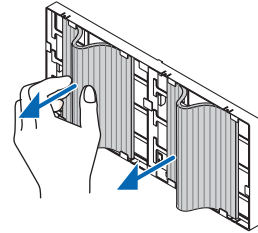

**4. Use a vacuum cleaner to vacuum all the dust inside.**

Get rid of dust in the filter.

**NOTE:**

- Whenever you vacuum the filter, use the soft brush attachment to vacuum. This is to avoid damage to the filter.
- Do not wash the filter with water. Doing so can result in filter clogging.

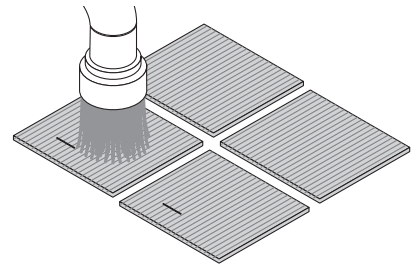

**5. Remove the dust on the front and back of the filter unit.**

- Please also remove all dust from the filter cover of the projector.

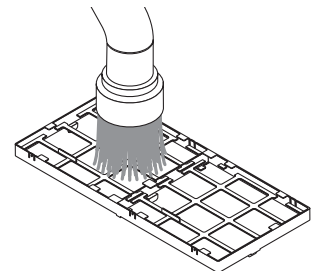

### 6. Attach 4 new filters to both sides of the filter unit.

The installation locations of the filters are differentiated by whether there are any slits (notches). Install the filter under the flange around the filter unit as follows.

(1) Attach the 2 filters with transparent frames fitted to the grips to the side of the filter unit where the knob is located.

- Turn over the side of the filter with the transparent box and then install it.

(2) Attach the 2 filters with the black lines to the side of the filter unit where there is no knob.

- Turn over the side of the filter with the black line, and then insert the slits into the protrusions on the filter unit to install it.

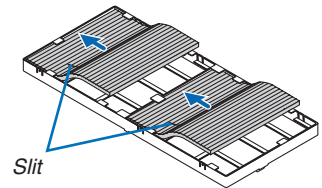
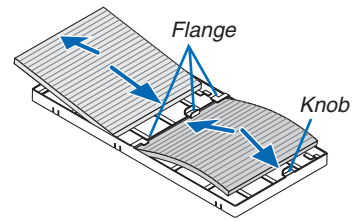

### 7. Mount the filter unit back onto the projector cabinet.

Insert the filter unit onto the projector with the sides on which the left and right hooks are located on the outside.

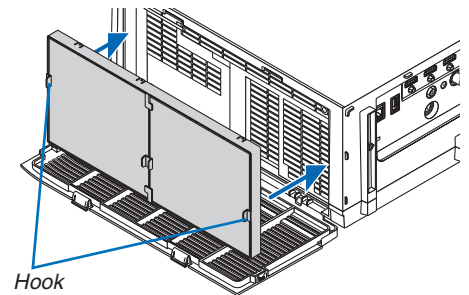

### 8. Close the filter cover.

After closing, push the filter cover near the buttons until a "click" sound is heard. The filter cover will be secured in position.

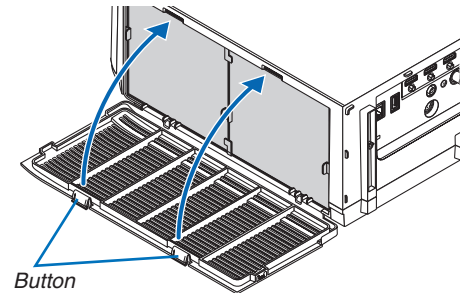

### 9. Clear the filter usage hours.

Plug the power cord into the wall outlet, and then turn on the projector.

From the menu, select [RESET] → [CLEAR FILTER HOURS].  
(→ page 132)

The interval time to clean the filters is set to [OFF] at time of shipment. When using the projector as it is, you do not clear the filter usage

## ② Cleaning the Lens

- Turn off the projector before cleaning.
- The projector has a plastic lens. Use a commercially available plastic lens cleaner.
- Do not scratch or mar the lens surface as a plastic lens is easily scratched.
- Never use alcohol or glass lens cleaner as doing so will cause damage to the plastic lens surface.

### WARNING

- Please do not use a spray containing flammable gas to remove dust attached to the lens, etc. Doing so may result in fires.

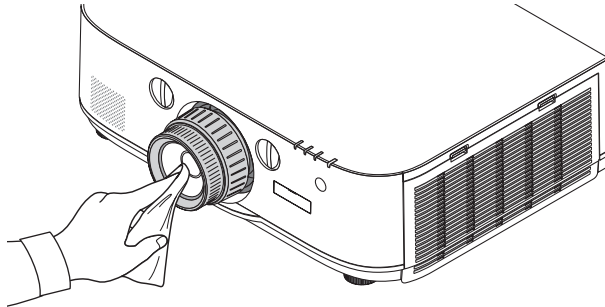

## ③ Cleaning the Cabinet

Turn off the projector, and unplug the projector before cleaning.

- Use a dry soft cloth to wipe dust off the cabinet.  
If heavily soiled, use a mild detergent.
- Never use strong detergents or solvents such as alcohol or thinner.
- When cleaning the ventilation slits or the speaker using a vacuum cleaner, do not force the brush of the vacuum cleaner into the slits of the cabinet.

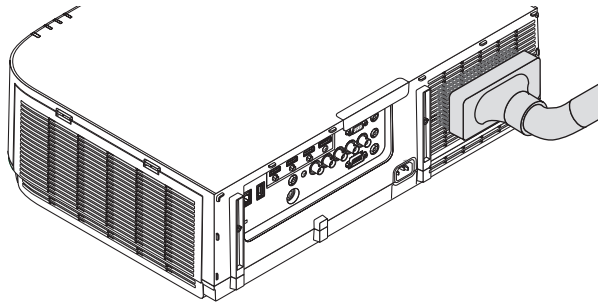

*Vacuum the dust off the ventilation slits.*

- Clogged ventilation slits may cause a rise in the internal temperature of the projector, resulting in malfunction.
- Do not scratch or hit the cabinet with your fingers or any hard objects
- Contact your dealer for cleaning the inside of the projector.

*NOTE: Do not apply volatile agent such as insecticide on the cabinet, the lens, or the screen. Do not leave a rubber or vinyl product in prolonged contact with it. Otherwise the surface finish will be deteriorated or the coating may be stripped off.*

## 4 Replacing the Lamp and the Filters

When the lamp reaches the end of its life, the LAMP indicator in the cabinet will blink red and the message “THE LAMP HAS REACHED THE END OF ITS USABLE LIFE. PLEASE REPLACE THE LAMP AND FILTER. USE THE SPECIFIED LAMP FOR SAFETY AND PERFORMANCE.” will appear (\*). Even though the lamp may still be working, replace the lamp to maintain the optimal projector performance. After replacing the lamp, be sure to clear the lamp hour meter. (→ page 131)

### CAUTION

- DO NOT TOUCH THE LAMP immediately after it has been used. It will be extremely hot. Turn the projector off and then disconnect the power cord. Allow at least one hour for the lamp to cool before handling.
- Use the specified lamp for safety and performance.
- DO NOT REMOVE ANY SCREWS except one lamp cover screw and two lamp housing screws. You could receive an electric shock.
- Do not break the glass on the lamp housing.  
Keep finger prints off the glass surface on the lamp housing. Leaving finger prints on the glass surface might cause an unwanted shadow and poor picture quality.
- The projector will turn off and go into standby mode when you continue to use the projector for another 100 hours after the lamp has reached the end of its life. If this happens, be sure to replace the lamp. If you continue to use the lamp after the lamp reaches the end of its life, the lamp bulb may shatter, and pieces of glass may be scattered in the lamp case. Do not touch them as the pieces of glass may cause injury. If this happens, contact your NEC dealer for lamp replacement.

---

*\*NOTE: This message will be displayed under the following conditions:*

- for one minute after the projector has been powered on
- when the  (POWER) button on the projector cabinet or the STANDBY button on the remote control is pressed

*To turn off the message, press any button on the projector cabinet or the remote control.*

---

Optional lamp and tools needed for replacement:

- Phillips screwdriver (plus-head)
- Replacement lamp:  
NP26LP

### Flow of Replacing the Lamp and the Filters

**Step 1.** *Replace the lamp*

**Step 2.** *Replace the filters (→ page 181)*

**Step 3.** *Clear the lamp usage hours and the filter usage hours (→ page 131, 132)*



### To replace the lamp:

#### 1. Remove the lamp cover.

(1) Loosen the lamp cover screw

- The lamp cover screw is not removable.

(2) Pull the bottom of the lamp cover towards you and remove it.

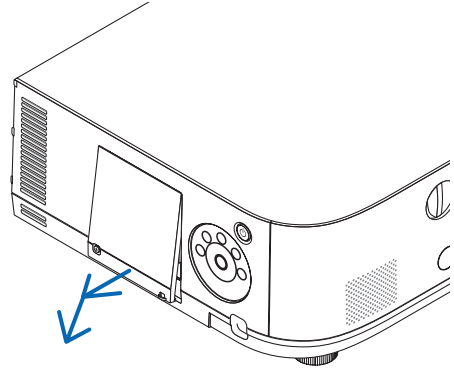
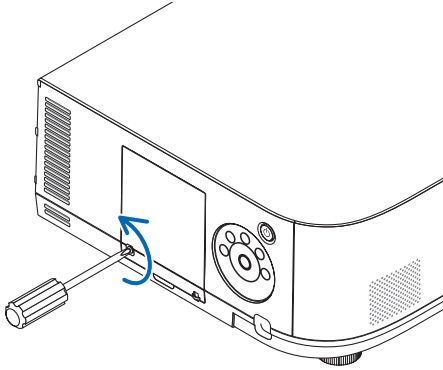

#### 2. Remove the lamp housing.

(1) Loosen the two screws securing the lamp housing until the phillips screwdriver goes into a freewheeling condition.

- The two screws are not removable.
- There is an interlock on this case to prevent the risk of electrical shock. Do not attempt to circumvent this interlock.

(2) Remove the lamp housing by holding it.

**⚠ CAUTION:**

Make sure that the lamp housing is cool enough to before removing it.

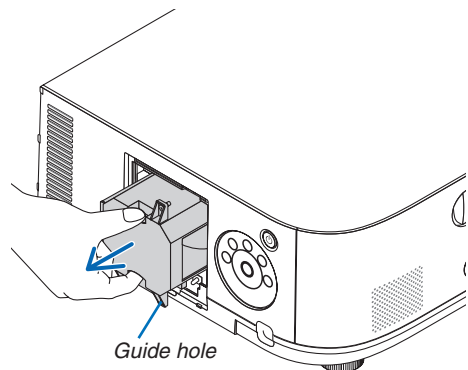
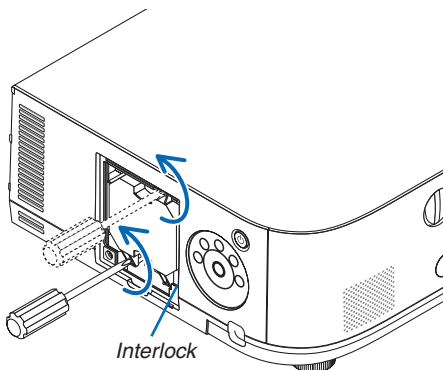

### 3. Install a new lamp housing.

- (1) Insert a new lamp housing until the lamp housing is plugged into the socket.
- (2) Position so that the guide hole in the bottom right of the lamp house is over the protrusion on the projector then press all the way in.
- (3) Secure it in place with the two screws.
  - Be sure to tighten the screws.

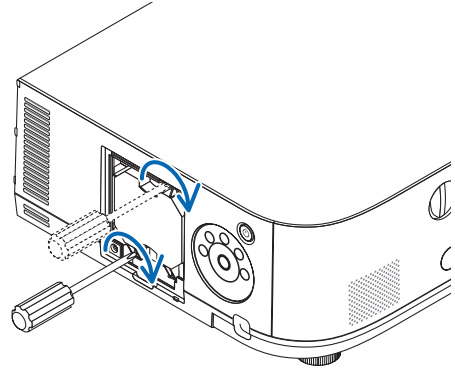
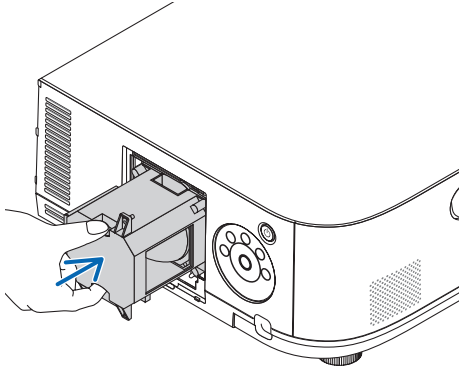

### 4. Reattach the lamp cover.

- (1) Insert the top edge of the lamp cover into the groove in the projector and close the lamp cover.
- (2) Tighten the screw to secure the lamp cover.
  - Be sure to tighten the screw.

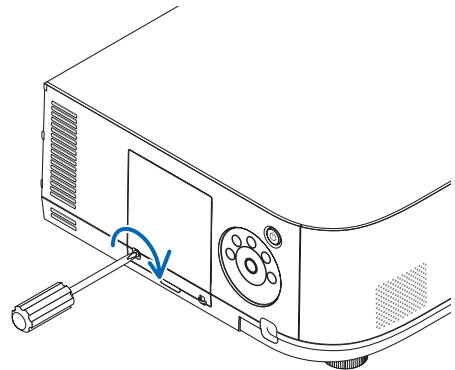
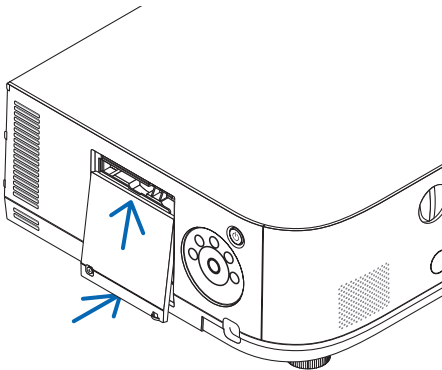

**This completes the lamp replacement.  
Go on to the filter replacement.**

#### NOTE:

- When you continue to use the projector for another 100 hours after the lamp has reached the end of its life, the projector cannot turn on and the menu is not displayed. If this happens, press the HELP button on the remote control for 10 seconds to reset the lamp clock back to zero. When the lamp time clock is reset to zero, the LAMP indicator goes out.
- For portrait projection, the power supply will be switched off when the lamp replacement time (estimated)\* is reached. A lamp replacement message will be displayed 100 hours before the lamp replacement time is reached.

\* The replacement time is not guaranteed.

### To replace the filters:

Four filters are packaged with the replacement lamp.

Honeycomb filter (coarse mesh): Large and small sizes (attached to the outside of the filter unit)

Accordion filter (fine mesh): Large and small sizes (attached to the inside of the filter unit)

---

#### NOTE:

- Replace all four filters at the same time.
  - Before replacing the filters, wipe off dust and dirt from the projector cabinet.
  - The projector is precision equipment. Keep out dust and dirt during filter replacement.
  - Do not wash the filters with soap and water. Soap and water will damage the filter membrane.
  - Put filters into place. Incorrect attachment of a filter may cause dust and dirt to get into the inside of the projector.
- 

Before replacing the filters, replace the lamp. (→ page 179)

#### 1. Press down on the buttons on the left and right and then pull the filter cover towards you to open it.

The cover will open about 90 degrees before it stops.

##### When mounting the projector to a ceiling

The filter cover will open about 90 degrees before it comes to a stop at the stopper position. Remove your hands as the stopper will be detached if it is opened further. The filter cover will stop at a position of about 90 degrees.

However, the filter cover may close if the projector vibrates.

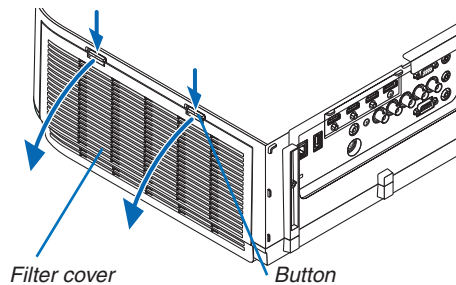

#### 2. Remove the filter unit by pulling out the tab.

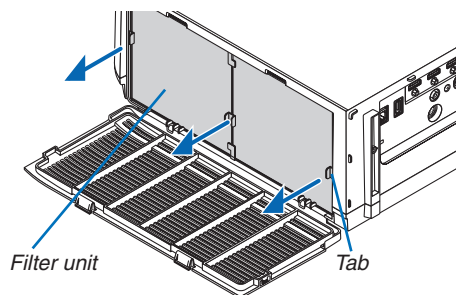

### 3. Remove the four filters.

Hold onto the filters fitted to both sides of the filter unit to remove the filter unit.

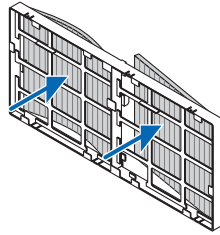
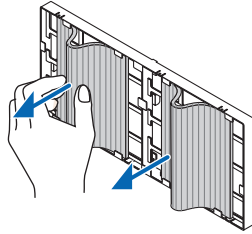

### 4. Remove dust from the filter unit and the filter cover.

Clean both outside and inside.

### 5. Attach 4 new filters to both sides of the filter unit.

The installation locations of the filters are differentiated by whether there are any slits (notches). Install the filter under the flange around the filter unit as follows.

(1) Attach the 2 filters with transparent frames fitted to the grips to the side of the filter unit where the knob is located.

- Turn over the side of the filter with the transparent box and then install it.

(2) Attach the 2 filters with the black lines to the side of the filter unit where there is no knob.

- Turn over the side of the filter with the black line, and then insert the slits into the protrusions on the filter unit to install it.

### 6. Mount the filter unit back onto the projector cabinet.

Insert the filter unit onto the projector with the sides on which the left and right hooks are located on the outside.

### 7. Close the filter cover.

After closing, push the filter cover near the buttons until a “click” sound is heard. The filter cover will be secured in position.

**This completes the filter replacement.**  
Go on to the clearing lamp and filter hour meters.

### To clear the lamp usage hours and the filter usage hours:

1. Place the projector where you use it.

2. Plug the power cord into the wall outlet, and then turn on the projector.

3. Clear the lamp usage hours and the filter usage hours.

1. From the menu, select [RESET] → [CLEAR LAMP HOURS] and reset the lamp usage hours.
2. Select [CLEAR FILTER HOURS] and reset the filter usage hours. (→ page 132)

# 8. User Supportware

## ① Operating Environment for Software Included on CD-ROM

### Names and Features of Bundled Software Programs

Name of software program	Features
Virtual Remote Tool (Windows only)	When connecting the computer and projector using the network (wired LAN), the Virtual Remote screen will appear in the computer screen and operations such as signal switchover and power on/off of the projector will be possible. It is also possible to send an image to the projector and register it as the background logo. Once the image is registered, it can be locked to prevent the logo from being overwritten.
Image Express Utility Lite	<ul style="list-style-type: none"><li>• This is a software program used to project your computer's screen, streaming movie, or sound from the computer over the wired/wireless network. The computer cable (VGA) is not required. (→ page 196)</li><li>• This software program can be used to control the power ON/OFF and source selection of the projector from your computer.</li><li>• The Geometric Correction Tool (GCT) and audio function allows you to correct distortion of images projected on a curved wall. (→ page 203) The GCT function is not available for streaming video.</li></ul>
Image Express Utility Lite for Mac OS	<ul style="list-style-type: none"><li>• This is a software program used to project your computer's screen over the wired/wireless network. The computer cable (VGA) is not required. (→ page 202)</li><li>• This software program can be used to control the power ON/OFF and source selection of the projector from your computer.</li></ul>
Image Express Utility 2.0 (Windows only)	<ul style="list-style-type: none"><li>• This is a software program used to send the screens of your personal computers to the projector via wired/wireless LAN (Meeting mode). Projected images can be transferred and saved to personal computers. When "Meeting Mode" is used, projected images can be sent and saved to the personal computers. Images can be sent from a personal computer to not only one projector but also to two or more projectors at the same time. (→ page 205)</li></ul>
Desktop Control Utility 1.0 (Windows only)	<ul style="list-style-type: none"><li>• This is a software program used to operate the desktop screen of a personal computer at a remote location by using a projector via wired/wireless LAN. (→ page 216)</li></ul>
PC Control Utility Pro 4 PC Control Utility Pro 5 (for Mac OS)	This is a software program used to operate the projector from the computer when the computer and the projector are connected with LAN. (→ page 192) <ul style="list-style-type: none"><li>• PC Control Utility Pro 4 can be used with a serial connection.</li></ul>

#### NOTE:

- Transmission using a wireless LAN is not possible for HDBaseT models.
- To connect the projector to the network by using the Virtual Remote Tool, PC Control Utility Pro 4, PC Control Utility Pro 5, please configure the settings of [SETUP] → [NETWORK SETTINGS] in the on-screen menu (→ page 122).  
MM models does not support the connection to the wired LAN/wireless LAN configured in [NETWORK SETTINGS (MM)] (→ page 138).
- Image Express Utility Lite does not support "Meeting Mode" in Image Express Utility 2.0 included with our other models.
- For MM models, take note of the following point when using the three software (Image Express Utility Lite (for Windows and Mac OS), Image Express Utility 2.0, Desktop Control Utility 1.0) in the [NETWORK STANDBY] mode.  
When the projector is in the [NETWORK STANDBY] mode, communications will not be possible for about 20 seconds after the power supply of the projector is turned on.

## Download service

For the update information about these software programs, visit our website:

URL: <http://www.nec-display.com/dl/en/index.html>

## Operating Environment

The following is the operating environment for Image Express Utility Lite. For the operating environment of other software program, refer to the help function of each software program.

### [Windows]

Supported OS	<p>Windows 8 (Core Edition)          Windows 8 Pro          Windows 8 Enterprise          Windows 7 Home Basic          Windows 7 Home Premium          Windows 7 Professional          Windows 7 Ultimate          Windows 7 Enterprise          Windows Vista Home Basic          Windows Vista Home Premium          Windows Vista Business          Windows Vista Ultimate          Windows Vista Enterprise          Windows XP Home Edition (32-bit version) Service Pack 3 or later          Windows XP Professional (32-bit version) Service Pack 3 or later</p> <ul style="list-style-type: none"> <li>• Windows power-saving function is not supported.</li> <li>• To use the audio transfer capability, Windows 8/Windows 7/Windows Vista Service Pack 1 or later is required.</li> </ul>
Processor	<ul style="list-style-type: none"> <li>• Windows 8/Windows 7/Windows Vista              Pentium M 1.2 GHz equivalent or higher required              Dual core 1.5 GHz or higher recommended</li> <li>• Windows XP              Pentium M 1.0 GHz equivalent or higher required              Dual core 1.0 GHz or higher recommended</li> </ul>
Memory	<ul style="list-style-type: none"> <li>• Windows 8/Windows 7/Windows Vista              512 MB or more required              1 GB or more recommended</li> <li>• Windows XP              256 MB or more required              512 MB or more recommended              * More memory may be required to run additional applications simultaneously.</li> </ul>
Graphic processor	<ul style="list-style-type: none"> <li>• Windows 8/Windows 7/Windows Vista              The "Graphics" score 3.0 or more of "Windows Experience Index" recommended.</li> </ul>
Network environment	<p>TCP/IP-compatible wired LAN or wireless LAN</p> <ul style="list-style-type: none"> <li>* Use a wireless LAN unit complying with the Wi-Fi standard.</li> <li>* Audio transfer capability requires 3 Mbps or more throughput.</li> </ul>
Resolution	<ul style="list-style-type: none"> <li>• Windows 8/Windows 7/Windows Vista              SVGA (800 × 600) or higher required              XGA (1024 × 768) recommended</li> <li>• Windows XP              VGA (640 × 480) or higher required              XGA (1024 × 768) recommended              (1024 × 768 – 1280 × 800 recommended for WXGA type)</li> </ul>

Screen Colors	High Color (15 bits, 16 bits) True Color (24 bits, 32 bits) (recommended) • 256 or fewer colors are not supported.
---------------	--

### [Mac]

Supported OS	Mac OS X v10.6, v10.7, v10.8
Processor (CPU)	Intel® Core™ Duo processor 1.5 GHz or higher required Intel® Core™ 2 Duo processor 1.6 GHz or higher recommended * PowerPC® is not supported
Memory	512 MB or higher required
Network environment	Wired or wireless LAN required that supports TCP/IP * The following LAN adapters are verified to work with Image Express Utility Lite: <ul style="list-style-type: none"> <li>• Wired LAN adapter built into Mac</li> <li>• Wireless LAN adapter built into Mac</li> <li>• Apple USB Ethernet adapter</li> <li>• Apple Thunderbolt Ethernet adapter</li> </ul> “Easy Connection” supports only wireless LAN.
Supported Resolution	SVGA (800 × 600) or higher required XGA (1024 × 768) recommended (1024 × 768 – 1280 × 800 recommended for WXGA type)
Supported Screen Colors	16.70 million colors required

## ② Installing Software Program

### Installation for Windows software

The software programs except PC Control Utility Pro 5 support Windows 8, Windows 7, Windows Vista, and Windows XP.

#### NOTE:

- To install or uninstall each software program, the Windows user account must have “Administrator” privilege (Windows 8, Windows 7, Windows Vista) or “Computer Administrator” privilege (Windows XP).
- Exit all running programs before installation. If another program is running, the installation may not be completed.
- To run Virtual Remote Tool or PC Control Utility Pro 4 on Windows 8, Windows XP Home Edition, and Windows XP Professional, “Microsoft .NET Framework Version 2.0” is required. The Microsoft .NET Framework Version 2.0, 3.0 or 3.5 is available from Microsoft’s web page. Download and install it on your computer.

#### 1 Insert the accompanying Projector CD-ROM into your CD-ROM drive.

The menu window will be displayed.



#### TIP:

If the menu window will not be displayed, try the following procedure.

For Windows 7

1. Click “start” on Windows.
2. Click “All Programs” → “Accessories” → “Run”.
3. Type your CD-ROM drive name (example: “Q:\”) and “LAUNCHER.EXE” in “Name”. (example: Q:\LAUNCHER.EXE)
4. Click “OK”.

The menu window will be displayed.



### 2 Click a software program you wish to install on the menu window.

The installation will start.

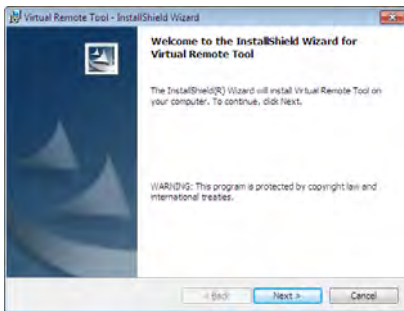

- Follow the instructions on the installer screens to complete the installation.

TIP:

---

### Uninstalling a Software Program

#### Preparation:

Exit the software program before uninstalling. To uninstall the software program, the Windows user account must have “Administrator” privilege (Windows 8, Windows 7, and Windows Vista) or “Computer Administrator” privilege (Windows XP).

- **For Windows 8/Windows 7/Windows Vista**

- 1 Click “Start” and then “Control Panel”.

The Control Panel window will be displayed.

- 2 Click “Uninstall a program” under “Programs”

The “Programs and Features” window will be displayed.

- 3 Select the software program and click it.

- 4 Click “Uninstall/Change” or “Uninstall”.

- When the “User Account Control” window is displayed, click “Continue”.

Follow the instructions on the screens to complete the uninstallation.

- **For Windows XP**

- 1 Click “Start” and then “Control Panel”.

The Control Panel window will be displayed.

- 2 Double-click “Add / Remove Programs”.

The Add / Remove Programs window will be displayed.

- 3 Click the software program from the list and then click “Remove”.

Follow the instructions on the screens to complete the uninstallation.

---

### Using on Mac OS

#### **[Example] Install PC Control Utility Pro 5 on the computer.**

**1. Insert the accompanying Projector CD-ROM in your Mac CD-ROM drive.**

*The CD-ROM icon will be displayed on the desktop.*

**2. Double-click the CD-ROM icon.**

*The CD-ROM window will be displayed.*

**3. Double-click the “Mac OS X” folder.**

**4. Double-click “PC Control Utility Pro 5.pkg”.**

*The installer will start.*

**5. Click “Next”.**

*“END USER LICENSE AGREEMENT” screen will be displayed.*

**6. Read “END USER LICENSE AGREEMENT” and click “Next”.**

*The confirmation window will be displayed*

**7. Click “I accept the terms in the license agreement”.**

*Follow the instructions on the installer screens to complete the installation.*

*TIP:*

---

#### • Uninstalling a software program

**1. Put the “Image Express Utility Lite” or “PC Control Utility Pro 5” folder to the Trash icon.**

**2. Put the configuration file of Image Express Utility Lite or PC Control Utility Pro 5 to the Trash icon.**

- *The configuration file of Image Express Utility Lite is located in “/Users/<your user name>/Library/Preferences/jp.needs.Image-Express-Utility-Lite.plist”.*
  - *The configuration file of PC Control Utility Pro 5 is located in “/Users/<your user name>/Application Data/NEC Projector User Supportware/PC Control Utility Pro 5”.*
-

### ③ Operating the Projector Via the LAN (Virtual Remote Tool)

This will help you perform operations such as projector's power on or off and signal selection via a LAN connection. It is also used to send an image to the projector and register it as the logo data of the projector. After registering it, you can lock the logo to prevent it from changing.

#### Control Functions

Power On/Off, signal selection, picture freeze, picture mute, audio mute, Logo transfer to the projector, and remote control operation on your PC.

Virtual Remote screen



Remote Control Window



Toolbar

This section provides an outline of preparation for use of Virtual Remote Tool.

For information on how to use Virtual Remote Tool, see Help of Virtual Remote Tool. (→ page 191)

#### TIP:

- *Virtual Remote Tool can be used also with a serial connection.*

#### NOTE:

- *Logo data (graphics) that can be sent to the projector with Virtual Remote Tool has the following restrictions: (Only via serial or LAN connection)*
  - \* *File size: Within 256 kilobytes*
  - \* *Image size: Within the resolution of the projector*
  - \* *File format: PNG (Full color)*
- *Logo data (image) sent using the Virtual Remote Tool will be displayed in the center with the surrounding area in black.*
- *To put the default "NEC logo" back in the background logo, you need to register it as the background logo by using the image file (PA622U/NP-PA522U/PA621U/PA521U: \Logo\necpj\_bbwux.png, PA672W/PA572W/PA671W/PA571W: \Logo\necpj\_bbw\_x.png, PA722X/NP-PA622X/PA721X/PA621X: \Logo\necpj\_bb\_x.png) included on the supplied Projector CD-ROM.*

### Connect the projector to a LAN.

Connect the projector to the LAN by following the instructions in “Connecting to a Wired LAN” (→ page 169) and “9. Controlling the Projector by Using an HTTP Browser” (→ page 44)

### Start Virtual Remote Tool

#### Start using the shortcut icon

- Double-click the shortcut icon  on the Windows Desktop.



#### Start from the Start menu

- Click [Start] → [All Programs] or [Programs] → [NEC Projector User Supportware] → [Virtual Remote Tool] → [Virtual Remote Tool].

When Virtual Remote Tool starts for the first time, “Easy Setup” window will be displayed.

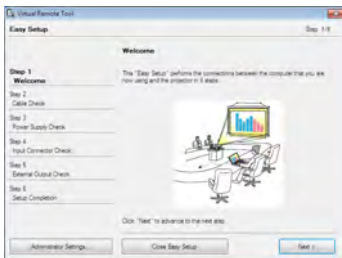

The “Easy Setup” feature is not available on this model. Click “Close Easy Setup”.

Closing the “Easy Setup” window will display the “Projector List” window.

Select your projector you wish to connect. This will display the Virtual Remote screen.



#### NOTE:

- When [NORMAL] is selected for [STANDBY MODE] from the menu, the projector cannot be turned on via network connection.

#### TIP:

- The Virtual Remote Tool screen (or Toolbar) can be displayed without displaying “Easy Setup” window. To do so, click to place a check mark for “ Do not use Easy Setup next time” on the screen.

## Exiting Virtual Remote Tool

- 1 Click the Virtual Remote Tool icon  on the Taskbar.

The pop-up menu will be displayed.

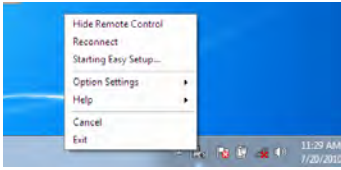

- 2 Click "Exit".

The Virtual Remote Tool will be closed.

## Viewing the help file of Virtual Remote Tool

- Displaying the help file using the taskbar

- 1 Click the Virtual Remote Tool icon  on the taskbar when Virtual Remote Tool is running.

The pop-up menu will be displayed.

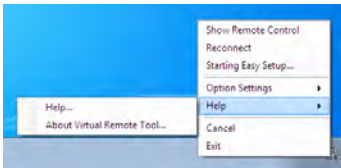

2. Click "Help".

The Help screen will be displayed.

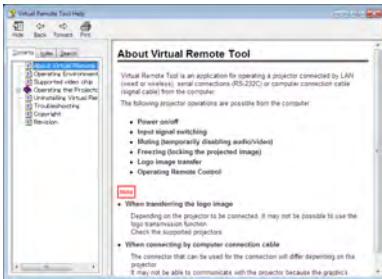

- Displaying the help file using the Start Menu.

1. Click "Start". "All programs" or "Programs". "NEC Projector User Supportware". "Virtual Remote Tool". and then "Virtual Remote Tool Help" in this order.

The Help screen will be displayed.

## ④ Controlling the Projector over a LAN (PC Control Utility Pro 4/Pro 5)

Using the utility software “PC Control Utility Pro 4” or “PC Control Utility Pro 5” included on the companion Projector CD-ROM, the projector can be controlled from a computer over a LAN.

PC Control Utility Pro 4 is a program compatible with Windows. (→ this page)

PC Control Utility Pro 5 is a program compatible with Mac OS. (→ page 195)

### Control Functions

Power On/Off, signal selection, picture freeze, picture mute, audio mute, adjusting, error message notification, event schedule.

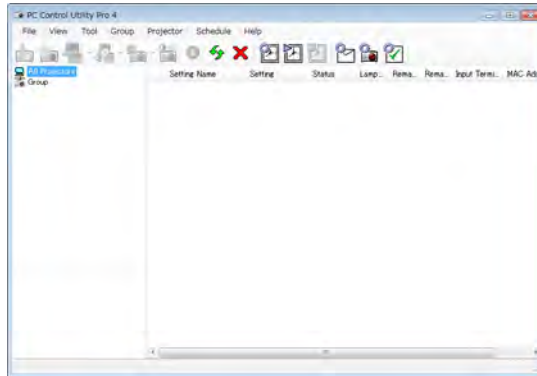

Screen of PC Control Utility Pro 4

This section provides an outline of preparation for use of PC Control Utility Pro 4/Pro 5. For information on how to use PC Control Utility Pro 4/Pro 5, see Help of PC Control Utility Pro 4/Pro 5. (→ page 194, 195)

Step 1: Install PC Control Utility Pro 4/Pro 5 on the computer.

Step 2: Connect the projector to a LAN.

Step 3: Start PC Control Utility Pro 4/Pro 5.

- To run PC Control Utility Pro 4 on Windows 8, Windows XP Home Edition and Windows XP Professional, “Microsoft .NET Framework” is required. The Microsoft .NET Framework Version 2.0, 3.0 or 3.5 is available from Microsoft’s web page. Download and install the it on your computer.

*TIP:*

- *PC Control Utility Pro 4 can be used with a serial connection.*

### Using on Windows

#### Step 1: Install PC Control Utility Pro 4 on the computer

*NOTE:*

- *To install or uninstall the program, the Windows user account must have [Administrator] privilege (Windows 8, Windows 7, Windows Vista and Windows XP)*
- *Exit all running programs before installation. If another program is running, the installation may not be completed.*

#### 1 Insert the accompanying Projector CD-ROM into your CD-ROM drive.

*The menu window will be displayed.*

**TIP:**

If the menu window will not be displayed, try the following procedure.

For Windows 7:

1. Click **“start” on Windows.**
2. Click **“All Programs” → “Accessories” → “Run”.**
3. Type your CD-ROM drive name (example: **“Q:\”**) and **“LAUNCHER.EXE”** in **“Name”**. (example: **Q:\LAUNCHER.EXE**)
4. Click **“OK”**.  
the menu window will be displayed.

**2 Click “PC Control Utility Pro 4” on the menu window.**

The installation will start.

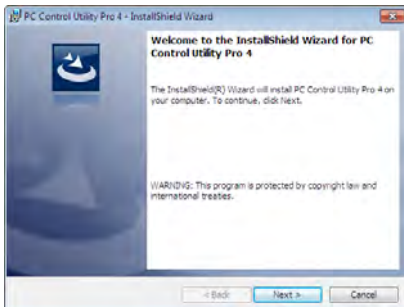

When the installation is complete, the Welcome window will be displayed.

**3 Click “Next”.**

“END USER LICENSE AGREEMENT” screen will be displayed.

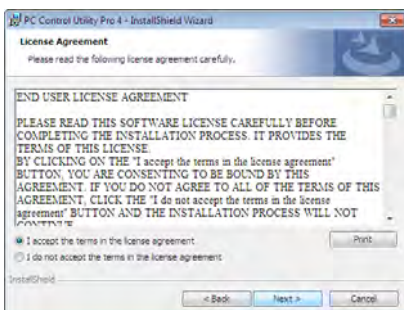

Read “END USER LICENSE AGREEMENT” carefully.

**4 If you agree, click “I accept the terms in the license agreement” and then click “Next”.**

- Follow the instructions on the installer screens to complete the installation.
- When the installation is complete, you will return to the menu window.

**TIP:**

- Uninstalling PC Control Utility Pro 4

To uninstall PC Control Utility Pro 4, do the same procedures stated as in “Uninstalling a Software Program”. (→ page 187)

### Step 2: Connect the projector to a LAN.

Connect the projector to the LAN by following the instructions in “Connecting to a Wired LAN” (→ page 169) and “9. Controlling the Projector by Using an HTTP Browser” (→ page 44)

### Step 3: Start PC Control Utility Pro 4

Click “Start” → “All programs” or “Programs” → “NEC Projector User Supportware” → “PC Control Utility Pro 4” → “PC Control Utility Pro 4”.

---

**NOTE:**

- For the Schedule function of the PC Control utility Pro 4 to work, you must have your computer running and not in standby/sleep mode. Select “Power Options” from the “Control Panel” in Windows and disable its standby/sleep mode before running the scheduler.

[Example] For Windows 7:

Select “Control Panel” → “System and Security” → “Power Options” → “Change when the computer sleeps” → “Put the computer to sleep” → “Never”.

**NOTE:**

- When [NORMAL] is selected for [STANDBY MODE] from the menu, the projector cannot be turned on via the network (wired LAN) connection.
- 

**TIP:**

---

### Viewing the Help of PC Control Utility Pro 4

- **Displaying the Help file of PC Control Utility Pro 4 while it is running.**

Click “Help (H)” → “Help (H) ...” of window of PC Control Utility Pro 4 in this order.

The pop-up menu will be displayed.

- **Displaying the help file using the Start Menu.**

Click “Start” → “All programs” or “Programs” → “NEC Projector User Supportware” → “PC Control Utility Pro 4” → “PC Control Utility Pro 4 Help”.

The Help screen will be displayed.

---



### Using on Mac OS

#### Step 1: Install PC Control Utility Pro 5 on the computer

1. **Insert the accompanying Projector CD-ROM in your Mac CD-ROM drive.**

*The CD-ROM icon will be displayed on the desktop.*

2. **Double-click the CD-ROM icon.**

*The CD-ROM window will be displayed.*

3. **Double-click the “Mac OS X” folder.**

4. **Double-click “PC Control Utility Pro 5.pkg”.**

*The installer will start.*

5. **Click “Next”.**

*“END USER LICENSE AGREEMENT” screen will be displayed.*

6. **Read “END USER LICENSE AGREEMENT” and click “Next”.**

*The confirmation window will be displayed*

7. **Click “I accept the terms in the license agreement”.**

*Follow the instructions on the installer screens to complete the installation.*

#### Step 2: Connect the projector to a LAN

Connect the projector to the LAN by following the instructions in “Connecting to a Wired LAN” (→ page 169) and “9 Controlling the Projector by Using an HTTP Browser” (→ page 44)

#### Step 3: Start PC Control Utility Pro 5

1. **Open your Applications folder in Mac OS.**

2. **Click the “PC Control Utility Pro 5” folder.**

3. **Click the “PC Control Utility Pro 5” icon.**

*PC Control Utility Pro 5 will start.*

---

#### NOTE:

- For the Schedule function of the PC Control utility Pro 5 to work, you must have your computer running and not in sleep mode. Select “Energy Saver” from the “System Preferences” in Mac and disable its sleep mode before running the scheduler.
  - When [NORMAL] is selected for [STANDBY MODE] from the menu, the projector cannot be turned on via the network (wired LAN) connection.
- 

#### TIP:

---

#### Viewing the Help of PC Control Utility Pro 5

- **Displaying the Help file of PC Control Utility Pro 5 while it is running.**
- **From the menu bar, click “Help” → “Help” in this order.**

*The Help screen will be displayed.*

- **Displaying the Help using the Dock**

1. **Open “Application Folder” in Mac OS.**

2. **Click the “PC Control Utility Pro 5” folder.**

3. **Click the “PC Control Utility Pro 5 Help” icon.**

*The Help screen will be displayed.*

---

## 5 Projecting Your Computer's Screen Image or Video from the Projector over a LAN (Image Express Utility Lite) (MM Models)

Using Image Express Utility Lite contained on the supplied Projector CD-ROM allows you to send the computer's screen image to the projector over a wired or wireless LAN.

Image Express Utility Lite is a program compatible with Windows.

Image Express Utility Lite for Mac OS is a program compatible with Mac OS. (→ page 202)

This section will show you an outline about how to connect the projector to a LAN and to use Image Express Utility Lite. For the operation of Image Express Utility Lite, see the help of Image Express Utility Lite.

Step 1: install Image Express Utility Lite on the computer.

Step 2: Connect the projector to a LAN.

Step 3: Start Image Express Utility Lite.

*TIP:*

- *Image Express Utility Lite (for Windows) can be started from most commercially available removable media such as USB memory devices or SD cards without the need to install on your computer. (→ page 201)*

### What You can Do with Image Express Utility Lite

#### • Image transmission (for Windows and Mac OS)

- The screen of your computer can be sent to the projector via a wired or wireless network without a computer cable (VGA).
- By using "EASY CONNECTION" function, the complicated network settings can be simplified and the computer will automatically connect to the projector.
- The screen of your computer can be sent to up to four projectors at the same time.

#### • Audio transfer capability (for Windows only)

- Image Express Utility Lite allows you to send the computer's screen image and audio to the projector over wired/wireless LAN or USB connection.
- Audio transfer capability is available only when the computer connects with the projector in peer-to-peer network.

#### • Playing streaming video (for Windows only)

- Image Express Utility Lite allows you to send streaming video from the computer to a single projector over wired or wireless LAN without the need of connecting a computer cable. For list of supported movie files and playback requirements, see page 225 of "4. Using the Viewer".

#### • Geometric Correction Tool [GCT] (for Windows only)

See "6 Projecting an Image from an Angle (Geometric Correction Tool in Image Express Utility Lite)". (→ page 203)

*NOTE:*

- *When Image Express Utility Lite is used, the audio from the COMPUTER AUDIO IN Mini Jack (Stereo Mini) may not be synchronized with the video.*

### Using on Windows

#### Step 1: install Image Express Utility Lite on the computer.

---

**NOTE:**

- To install or uninstall the program, the Windows user account must have “Administrator” privilege (Windows 7, Windows Vista and Windows XP).
  - Exit all running programs before installation. If another program is running, the installation may not be completed.
  - Image Express Utility Lite will be installed to the system drive of your computer.  
If the message “There is not enough free space on destination” is displayed, free up enough space (about 100 MB) to install the program.
- 

**1. Insert the accompanying Projector CD-ROM into your CD-ROM drive.**

The menu window will be displayed.

**TIP:**

If the menu window will not be displayed, try the following procedure.

For Windows 7:

- 1. Click “start” on Windows.**
- 2. Click “All Programs” → “Accessories” → “Run”.**
- 3. Type your CD-ROM drive name (example: “Q:\”) and “LAUNCHER.EXE” in “Name”. (example: Q:\LAUNCHER.EXE)**
- 4. Click “OK”.**

The menu window will be displayed.

---

**2. Click “Installing Image Express Utility Lite” on the menu window.**

The installation will start.

“END USER LICENSE AGREEMENT” screen will be displayed.

Read “END USER LICENSE AGREEMENT” carefully

**3. If you agree, click “I agree.” and then click “Next”.**

- Follow the instructions on the installer screens to complete the installation.
- When the installation is complete, you will return to the menu window.

When the installation is complete, a completion message will be displayed.

**4. Click “OK”.**

This completes the installation.

---

**TIP:**

- Uninstalling Image Express Utility Lite

To uninstall Image Express Utility Lite, do the same procedures stated as in “Uninstalling a software program”. (→ page 188)

---

### Step 2: Connect the projector to a LAN.

Connect the projector to the LAN by following the instructions in “Connecting to a Wired LAN” (→ page 169) and “9. Controlling the Projector by Using an HTTP Browser” (→ page 44)

### Step 3: Start Image Express Utility Lite.

**1. On Windows, click “Start” → “All programs” → “NEC Projector UserSupportware” → “Image Express Utility Lite” → “Image Express Utility Lite”.**

*Image Express Utility Lite will start.*

*The select window for network connection will be displayed*

**2. Select Network and click “OK”.**

*The select window for destination will show a list of connectable projectors.*

- When connecting the computer directly to the projector by one-to-one, “Easy Connection” is recommended.

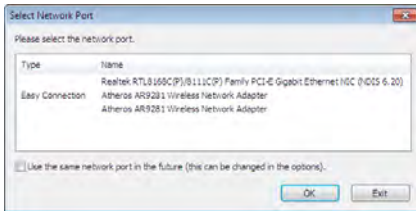

- When one or more networks for “EASY CONNECTION” are found, the “Easy Connection Selection Screen” window will be displayed.
- To verify the network used by the projector to be connected, display the [INPUT TERMINAL] → [ETHERNET] → [NETWORK SETTINGS (MM)] → [NETWORK INFORMATION] screen on the on-screen menu of the projector and check the “SSID” character string.

**3. Select the network you wish to connect, and click “Select”.**

*The target selection window will be displayed.*

**4. Place a check mark for projectors to be connected, and then click “Connect”.**

- When multiple projectors are displayed, display the [INPUT TERMINAL] → [ETHERNET] → [NETWORK SETTINGS (MM)] → [NETWORK INFORMATION] screen on the on-screen menu of the projectors to be connected and check the [IP ADDRESS].

*When connecting with the projector is established, you can operate the control window to control the projector. (→ page 199)*





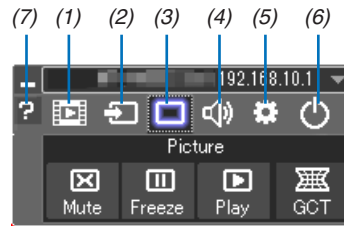

---

**NOTE:**

- Projectors in which the [STANDBY MODE] in the on-screen menu has been set to [NORMAL] (power indicator is lighted up in red) and those in which the [PROGRAM TIMER] has been set up (power indicator blinks slowly) will not be displayed in the connection destination options when the unit is in the standby mode.
-

## 5. Operate the control window.



- (1)  (Streaming) Displays the streaming window. Movie files on the PC can be transferred to the projector via the network and played on the projector. Refer to “Movie streaming function” in the help file of Image Express Utility Lite.
- (2)  (Source)..... Selects an input source of the projector.
- (3)  (Picture) .... Turns on or off AV-MUTE (Picture mute), and turns on or off FREEZE (Freeze a picture).
- (4)  (Sound) ..... Turns on or off AV-MUTE (Sound mute), play the sound and turns up or down the volume.
- (5)  (Others) ..... Uses “Update”, “HTTP Server”, “Settings” and “Information”.
- (6)  (Exit)..... Exit Image Express Utility Lite. You can also turn off the projector at the same time.
- (7)  (Help)..... Displays the help of Image Express Utility Lite.

TIP:

### Viewing the “Help” file of Image Express Utility Lite

- **Displaying the Help file of Image Express Utility Lite while it is running.**

*Click the [?] (help) icon on the control window.*

*The Help screen will be displayed.*

- **Displaying the Help file of GCT while it is running.**

*Click “Help” → “Help” on the edit window.*

*The Help screen will be displayed.*

- **Displaying the help file using the Start Menu.**

*Click “Start” → “All programs” or “Programs” → “NEC Projector User Supportware” → “Image Express Utility Lite” → “Image Express Utility Lite Help”.*

*The Help screen will be displayed.*

---

### Starting Image Express Utility Lite from a USB Memory or SD Card

Image Express Utility Lite can be started from commercially available removable media such as USB memory or SD cards if it is copied beforehand. This will eliminate the trouble of installing Image Express Utility Lite to your computer.

**1. Copy Image Express Utility Lite to removable media.**

*Copy all the folders and files (total size approx. 6MB) from the "IEU\_Lite (removable-media)" folder in the supplied Projector CD-ROM to the root directory of your removable media.*

**2. Insert your removable media into your computer.**

*The "AutoPlay" screen will be displayed on your computer.*

*TIP:*

- *If the "AutoPlay" screen is not displayed, open the folder from "Computer" ("My Computer" for Windows XP).*

**3. Click "Open folder to view files"**

*The IEU\_Lite.exe, other folder, and files will be displayed.*

**4. Double-click the "IEU\_Lite.exe" (  ) icon.**

*Image Express Utility Lite will start.*

---

**NOTE:**

- *The "EASY CONNECTION" function is not supported when Image Express Utility Lite is started from removable media.*
-

## Using on Mac OS

### Step 1: Install Image Express Utility Lite for Mac OS on the computer

1. Insert the accompanying Projector CD-ROM in your Mac CD-ROM drive.

The CD-ROM icon will be displayed on the desktop.

2. Double-click the CD-ROM icon.

The CD-ROM window will be displayed.

3. Double-click the “Mac OS X” folder.

4. Double-click “Image Express Utility Lite.dmg” in the “Image Express Utility Lite” folder.

The “Image Express Utility Lite” window will be displayed.

5. Drag and drop the “Image Express Utility Lite” folder to your Applications folder in Mac OS.

### Step 2: Connect the projector to a LAN

Connect the projector to the LAN by following the instructions in “Connecting to a Wired LAN” (→ page 169) and “9 Controlling the Projector by Using an HTTP Browser” (→ page 44)

### Step 3: Start Image Express Utility Lite for Mac OS

1. Open your Applications folder in Mac OS.
2. Double-click the “Image Express Utility Lite” folder.
3. Double-click the “Image Express Utility Lite” icon.

When Image Express Utility Lite for Mac OS starts, the select window for destination will be displayed.

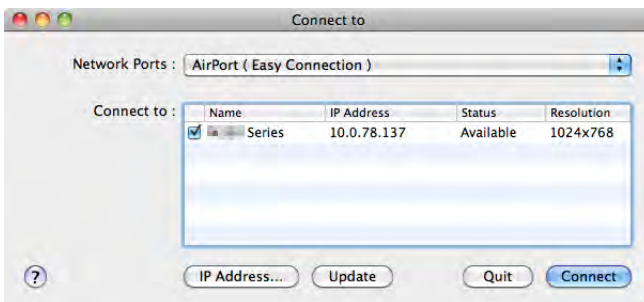

- At the first time of startup, “END USER LICENSE AGREEMENT” screen will be displayed before the select window for destination is displayed.  
Read “END USER LICENSE AGREEMENT” and select “I accept the terms in the license agreement”, and click “OK”.
4. Select a projector to be connected, and then click “Connect”.  
Your desktop screen will be displayed on the projector.

#### TIP:

Viewing the Help of Image Express Utility Lite for Mac OS

- From the menu bar, click “Help” → “Image Express Utility Lite Help” while Image Express Utility is running.  
The Help screen will be displayed



## ⑥ Projecting an Image from an Angle (Geometric Correction Tool in Image Express Utility Lite) (MM Models)

The Geometric Correction Tool (GCT) function allows you to correct distortion of images projected even from an angle.

### What you can do with GCT

- The GCT feature includes the following three functions
  - 4-point Correction:** You can fit a projected image within the border of the screen easily by align the four corners of an image to the ones of the screen.
  - Multi-point Correction:** You can correct a distorted image on the corner of a wall or irregular shaped screen by using many separated screens to correct the image as well as 4-point Correction.
  - Parameters Correction:** You can correct a distorted image by using a combination of transformational rules prepared in advance.

This section will show an example for use with 4-point Correction.

For information about “Multi-point Correction” and “Parameters Correction”, see the help file of Image Express Utility Lite. (→ page 200)

- Your correction data can be stored in the projector or your computer which can be restored when necessary.
- The GCT function is available with a wired or wireless LAN connection, and video cable.

### Projecting an Image from an Angle (GCT)

- For a video cable or LAN connection, install and start Image Express Utility Lite in your computer beforehand. (→ page 198)

Preparation: Adjust the projector position or the zoom so that the projected image can cover the whole screen area.

- Click the “” (Picture) icon and then the “” button.

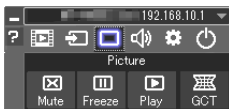

The “4-point Correction” window will be displayed.

- Click the “Start Correction” button and then “Start 4-point Correction” button.

A green frame and a mouse pointer (  ) will be displayed.

- Four [ ● ] marks will be appeared at four corners of the green frame

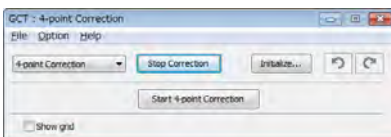
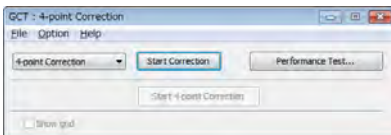

### 3. Use the mouse to click the [ ● ] mark of which corner you wish to move.

The currently selected [ ● ] mark will turn red.

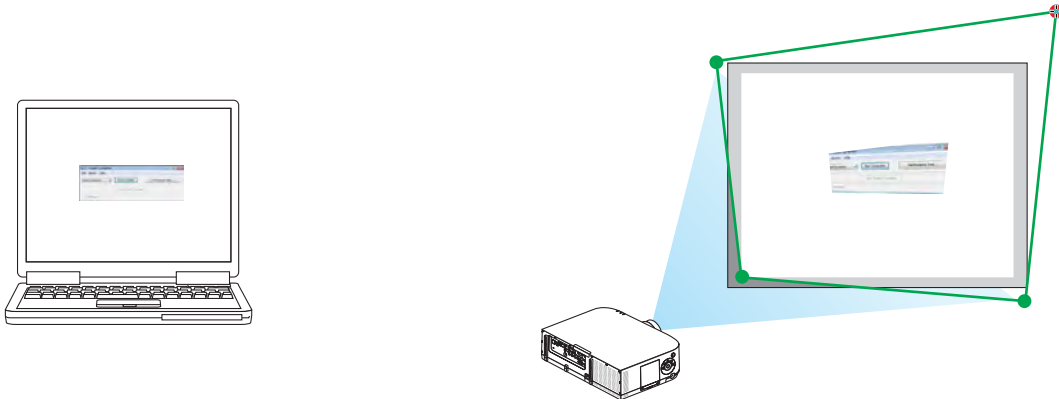

(In the above example, Windows screens are omitted for clarification.)

### 4. Drag the selected [ ● ] mark to the point you wish to correct and drop it.

- When you click somewhere within the project image area, the nearest [ ● ] mark will go to the position where the mouse cursor is.

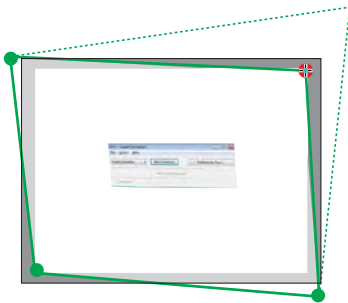

### 5. Repeat Step 3 and 4 to correct the distortion of the projected image.

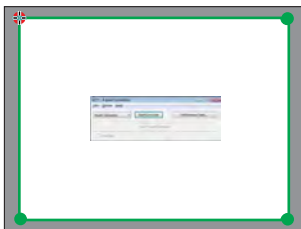

### 6. After completing, right-click the mouse.

The green frame and the mouse pointer will disappear from the projected image area. This will complete the correction.

### 7. Click the “X” (close) button on the “4-point Correction” window.

The “4-point Correction” window will disappear and the 4-point correction will take effect.

### 8. Click the “” button on the control window to exit the GCT.

TIP:

- After performing the 4-point correction, you can save the 4-point correction data to the projector by clicking “File” → “Export to the projector...” on the “4-point Correction” window.
- See the Help of Image Express Utility Lite for operating “4-point Correction” window and other functions than GCT. (→ page 200)

## ⑦ Projecting Images from the Projector over a LAN (Image Express Utility 2.0) (MM Models)

### What you can do with Image Express Utility 2.0

- Using Image Express Utility 2.0 allows you to send the screens of your computers to the projector via wired/wireless LAN.

The difference from Image Express Utility Lite is that projected images can be sent from a computer to not only one projector but also to two or more projectors at the same time.

When “Meeting Mode” is used, projected images can be sent and received between two or more computers.

- High-speed, high-quality image transmissions based on NEC’s original compression algorithm**

NEC’s original compression algorithm allows high-quality images to be sent over the network at high speed, from your computer to the projector.

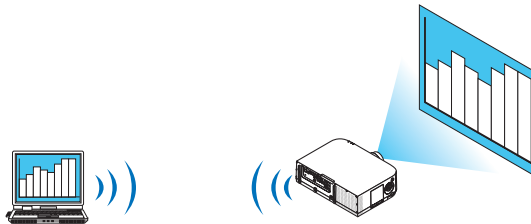

- Simultaneous projection by multiple projectors**

Images can be sent from a computer to not only one projector but also to two or more projectors at the same time.

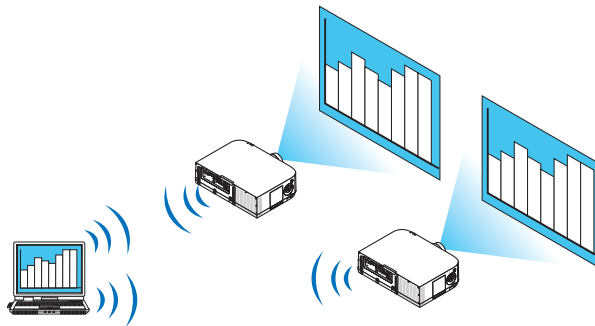

- “Easy Connection” function for connecting wireless LAN**

By using “Easy Connection” function\*<sup>1</sup>, the complicated setting of wireless LAN can be simplified.

\*<sup>1</sup> This function can be used when Windows XP is used as the OS and when you have a “Computer Administrator” privilege. If the OS is Windows 7/Windows Vista, input of logon password as “Administrator” may be prompted.

- **Projected images can be transferred and saved to computers.**

When “Meeting Mode” is used, projected images can be sent to the computers of all the participants (attendants) of a “Meeting”. The received images can be saved to your computer with a memo (text data) attached.

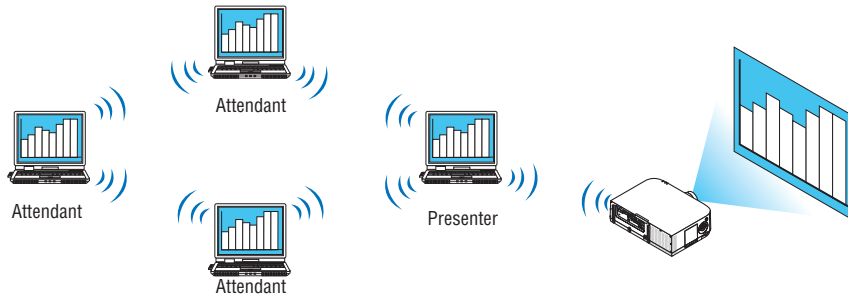

- **1-click switching of presenter**

When switching to another presenter during the conference, the participants (attendants) can simply click a button to switch over to the new presenter.

- **Central management of the projecting computer**

Using the Training Mode allows you to use a single computer (Manager) to manage which computer (Attendant) projects. Possible operation includes switching projecting computers to project from, as well as temporarily terminating communication with the projector.

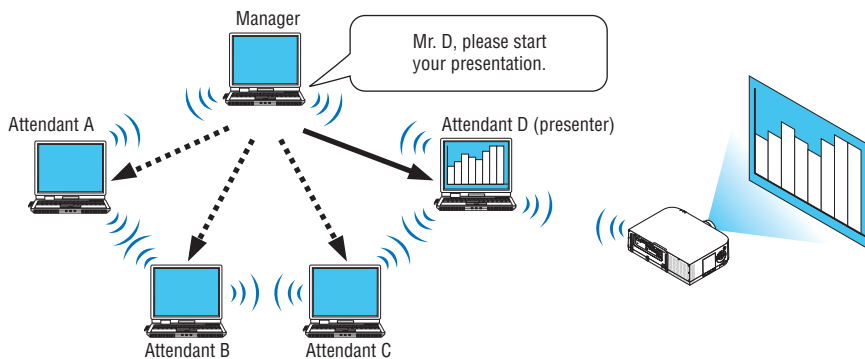

**NOTE:**

The Training Mode is not installed via the “Typical” installation option when Image Express Utility 2.0 is installed. To use Training Mode, select “Extension” installation option on the install selection screen that is displayed while Image Express Utility 2.0 installation is in progress, and select “Training Mode (Attendant)” or “Training Mode (Manager)”.

### Connecting the projector to a LAN

Connect the projector to the LAN by following the instructions in “Connecting to a Wired LAN” (→ page 169), “Connecting to a Wireless LAN” (→ page 170) and “9 Application Menus” (→ page 138)

### Basic Operation of Image Express Utility 2.0

This section explains the following three cases as examples of operating Image Express Utility 2.0.

- (1) Transferring images to the projector
- (2) Holding a conference
- (3) Participating in a conference

#### Sending Images to Projector

##### • Connecting projector

1 Turn on the power to the projector for which LAN has been set.

2 Click Windows [Start] → [All Programs] → [NEC Projector User Supportware] → [Image Express Utility 2.0] → [Image Express Utility 2.0 ], in that order.

The “Selection Of Network Connections” window will be displayed.

A list of the network equipment connected to your computer will be displayed.

##### IMPORTANT:

A screen like the one below is displayed when the software is started on a PC installed with Windows XP Service Pack 2 (SP2) (or later).

Click “Unblock” if this is displayed.

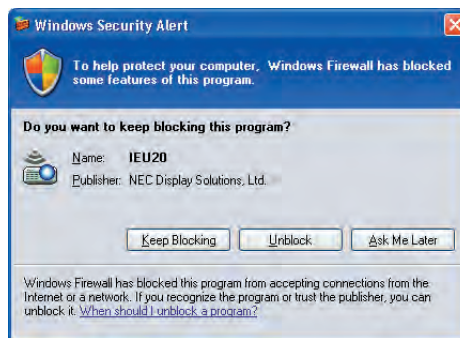

3 Select the network equipment that is to be used and click [OK].

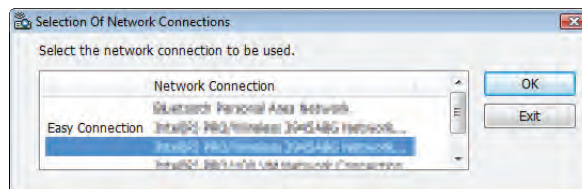

Select the network device displaying “Easy Connection” if the product LAN setting is for “Easy Connection.” This will call up the “Projector List” window.

#### 4 Check(☑) the projector to connect and click [Connect].

If the name of the projector to connect is not on the list or if it is hidden, click [Update].

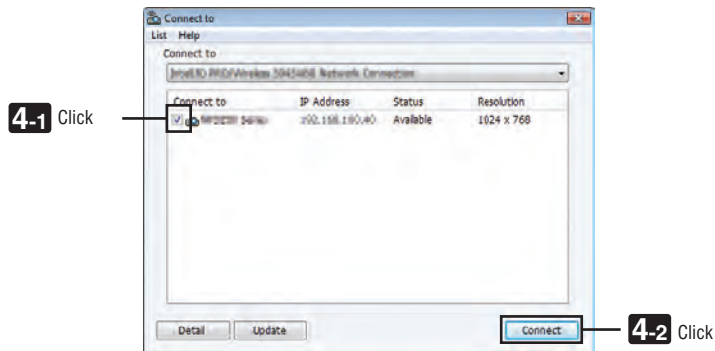

The screen of your computer will be projected from the projector.

At this time, the input signal of the projector will automatically change to "ETHERNET".

#### • Transferring images

When your computer is connected to the projector, the screen of the computer is projected from the projector as is. To make your presentation by using a PowerPoint file, open the PowerPoint file and start your presentation.

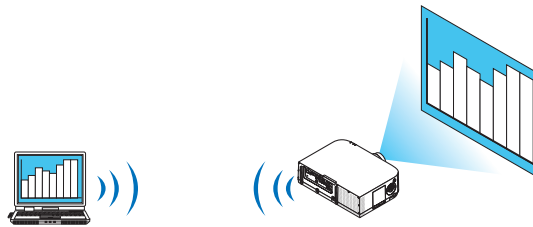

### • Stopping or resuming the transmission of images

The transmission of the screen of the computer to the projector can be temporarily stopped and then resumed.

- 1 Click the projector icon () on the Windows taskbar.

A pop-up menu will be displayed.

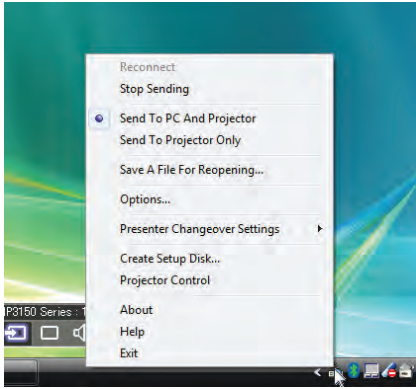

- 2 Click [Stop Sending].

The projector icon on the taskbar will change ( → .

---

#### NOTE:

Even if the screen of the computer is changed in this status, the image projected from the projector does not change. To manipulate the screen that should not be disclosed (projected from the projector), stop transmission.

---

- 3 Click the projector icon () on the Windows taskbar.

A pop-up menu will be displayed.

- 4 Click [Start Sending].

The projector icon on the taskbar will change ( → .

The transmission of the screen for the computer will be resumed, and the current screen of the computer will be projected from the projector.

### • End the transmission of images

Exit Image Express Utility 2.0.

- 1 Click the projector icon () on the Windows taskbar.

A pop-up menu will be displayed.

- 2 Click [Exit].

### Holding Conferences

- Holding conferences

1 Follow steps 1 through 4 in “Connecting projector” of “Sending Images to Projector” (→ page 207).

The screen of your computer will be projected from the projector.

- Disclose a file to the participants of the conference.

**NOTE:**

To disclose a file to the participants, selection can be made only in folder units.

Therefore, a folder only having files that can be disclosed to the participants must be created in advance.

1 Click the projector icon () on the Windows taskbar.

A pop-up menu will be displayed.

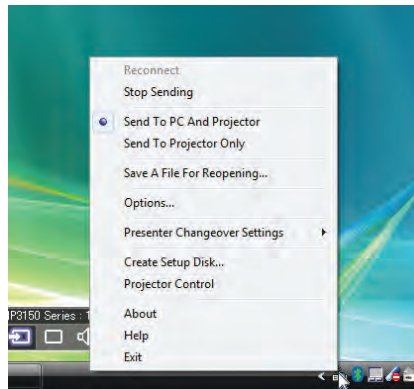

2 Before clicking [Send to PC and Projector], check that there is a “•” mark applied.

3 Click the [Image Express Utility 2.0] button on the taskbar.

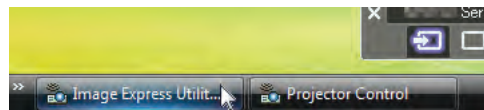

The presenter window will be opened.

4 Click [Select Folder].

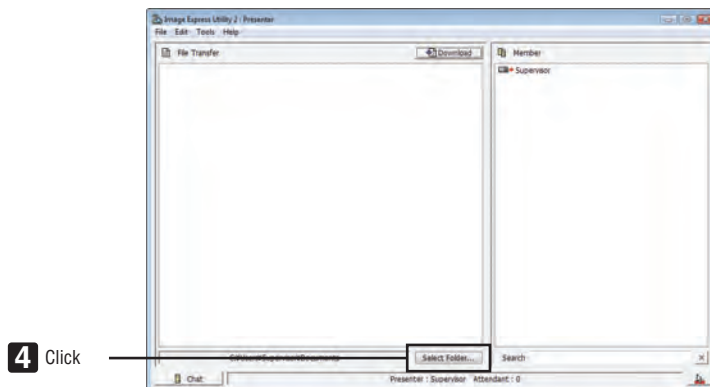



### 5 Select a folder saving the file to be disclosed to the participants, and click [OK].

The file in the selected folder will be displayed in the list of files to transfer.

### 6 Click [Download].

The file will be shown to the participants.

#### NOTE:

When the computer is connected to the projector, the computer screen that is in of being progress is also projected from the projector. To manipulate a screen that should not be shown (not projected), temporarily stop the transmission (→ page 209).

#### • Ending conference

##### 1 Click [File] in the presenter window, and click [Exit].

You can also end the conference by clicking [x] at the upper right of the presenter window.

### Participating in Conference

#### • Participating in conferences

##### 1 Click Windows [Start] → [All Programs] → [NEC Projector User Supportware] → [Image Express Utility 2.0] → [Image Express Utility 2.0 ], in that order.

The “Selection Of Network Connections” window will be displayed.

A list of the network equipment connected to your computer will be displayed.

#### IMPORTANT:

A screen like the one below is displayed when the software is started on a PC installed with Windows XP Service Pack 2 (SP2) (or later).

Click “Unblock” if this is displayed.

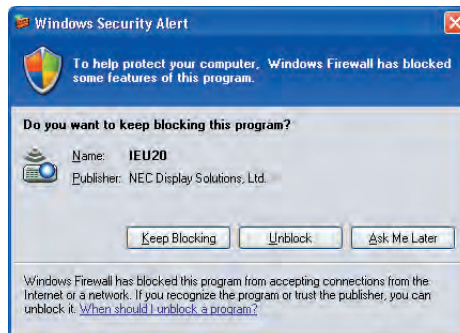

##### 2 Select the network equipment that is to be used and click [OK].

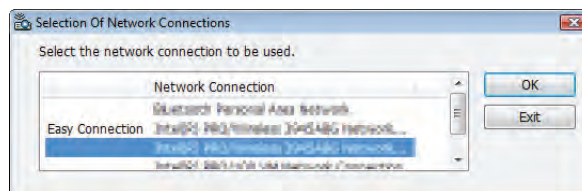

Select the network device displaying “Easy Connection” if the product LAN setting is for “Easy Connection.” This will call up the “ Meeting List” window.

**3 Click the Meeting Name to participate, and click [Connect].**

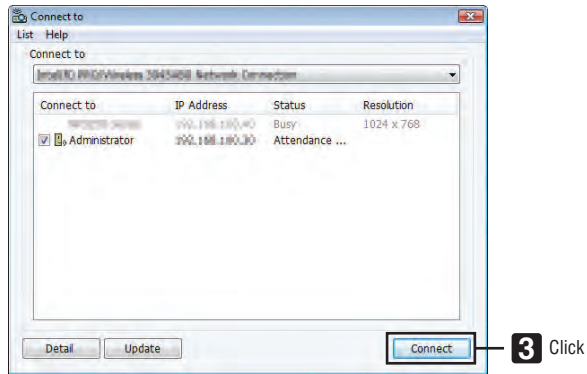

The computer will be connected to the selected conference and the attendant window will be displayed.

If the presenter selects "Send to PC And Projector", the image projected from the projector is displayed in the attendant window.



- Saving received images

- 1 Click [Memo] in the attendant window.

A memo pane will be displayed.

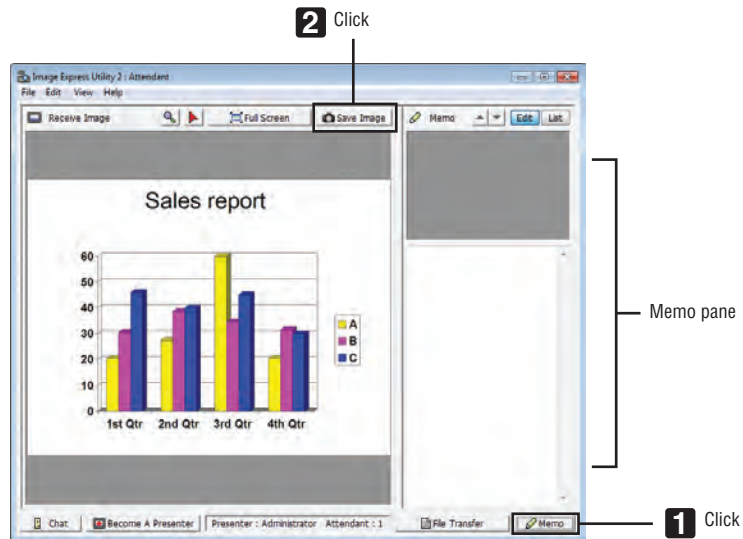

- 2 Click [Save Image] in the attendant window.

The image displayed in the attendant window will be saved.

- The saved image is added to the memo list and a thumbnail is displayed.
- A memo can be attached to the saved image.

**REFERENCE:**

- In case of Windows XP, a created file is saved to "My Documents\ImageExpress\" under the default settings. In case of Windows 7/Windows Vista, "Document\ImageExpress\" is the default folder to save a created file.
- A folder is created below the default folder based on the time and date of the conference, and the image is saved to a file in the created folder.

For example, if a conference is held at 11:20 on May 14, 2014, the default folder name on Windows XP will be "My Documents\ImageExpress\2014-05-14\_11-20\_Meeting Records".

In this folder, an HTML file named "Meeting Records" is created.

The saved image is saved in "Images" folder.

### • Downloading disclosed file

#### 1 Click [File Transfer] in the attendant window.

The “File Transfer” window will be opened.

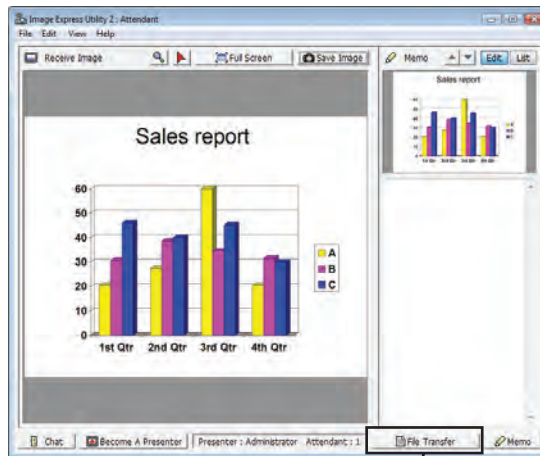

**1** Click

#### 2 Select a file to download, and click [Download].

Downloading will begin.

The progress of the downloading is displayed at the lower left of the window.

#### 3 When downloading is complete, click [File] in the “File Transfer” window, and click [Exit].

The “File Transfer” window will be closed.

#### REFERENCE:

- If “Open After Downloading” is checked, the file is opened by specified Windows application software after downloading is complete.
- In case of Windows XP, a created file is saved to “My Documents\ImageExpress\” under the default settings. In case of Windows 7/Windows Vista, “Document\ImageExpress\” is the default folder to save a created file.
- A folder is created below the default folder based on the time and date of the conference, and the image is saved to a file in the created folder.  
For example, if a conference is held at 11:20 on May 14, 2014, the default folder name on Windows XP will be “My Documents\ImageExpress\2014-05-14\_11-20\_Meeting Records”.

### • Changing presenter

Three types of settings may be made to change the presenter: “Not Approved”, “Approved”, and “Changing Prohibited” (these can be selected only by the presenter).

In the following example, “Not Approved” is selected.

- **Click [Become A Presenter] in the attendant window.**

*You will change from a participant to a presenter.*

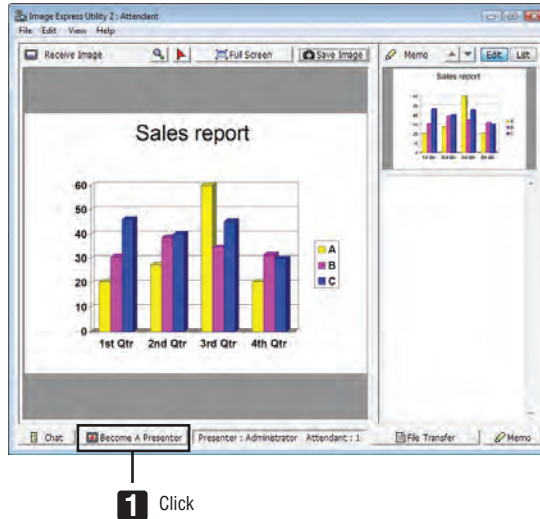

### • Leaving conference

Leave the conference and exit Image Express Utility 2.0.

- **Click [File] in the attendant window, and click [Exit].**

*You can also leave the conference by clicking [x] at the upper right of the attendant window.*

## 8 Using the Projector to Operate Your Computer over a LAN (Desktop Control Utility 1.0) (MM Models)

Using Desktop Control Utility 1.0 allows you to remotely operate your computer placed at a distance from the projector over a network (wired LAN or wireless LAN).

### What you can do with Desktop Control Utility 1.0

- A commercially available USB mouse is connected to the projector to operate the computer.
- Suppose, for example, a PowerPoint file to be presented in a conference is saved to a computer in your office. If this computer is connected to the projector in the conference room with LAN when the conference is held, the desktop screen of the computer in your office (Windows 8/Windows 7/Windows Vista/Windows XP) can be projected and the Power-Point file can be presented by operating the projector. In other words the computer does not need to be brought into the conference room.

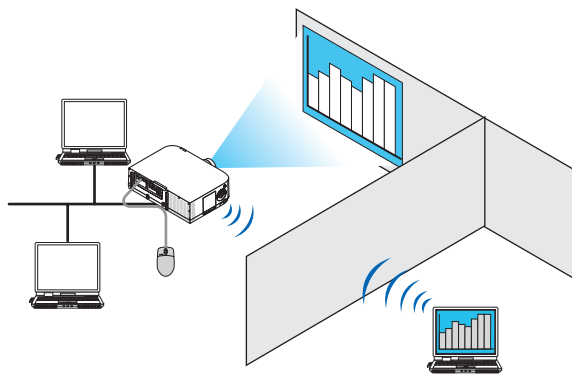

#### IMPORTANT:

- You can use the Desktop Control Utility 1.0 to operate a computer located in a separate room from the projector over a network. Therefore, care must be exercised to prevent any third party from viewing the screen of your computer (important documents), copying files, or turning off the power.  
*Dukane assumes no liability for any loss or damages arising from information leak or system failure while you are using Desktop Control Utility 1.0.*
- This will disconnect LAN connection when the computer goes in the standby mode while the Desktop Control Utility 1.0 is being used.  
*In the Windows 8/Windows 7/Windows Vista, select [Control Panel] → [Hardware and Sound] → [Power Options]. Set [Change when the computer sleeps] to [Never].  
In the Windows XP, click [Control Panel] → [Performance and Maintenance] → [Power Options] → [System Standby] → [Never].*
- The screen saver function is off while Desktop Control Utility 1.0 is running.

### Connecting the projector to a LAN

Connect the projector to the LAN by following the instructions in “Connecting to a Wired LAN” (→ page 169), “Connecting to a Wireless LAN” (→ page 170) and “9 Application Menus” (→ page 138)

### Using the projector to operate your computer's desktop screen

#### *IMPORTANT:*

- *In case of Windows 8/Windows 7/Windows Vista, disable the user account control before using Desktop Control Utility 1.0. Windows Vista has "User Account Control" function to protect the computer. The user account confirmation window may be displayed. Since Desktop Control Utility 1.0 cannot transfer the user account confirmation window, this window makes the operation unavailable. Before using Desktop Control Utility 1.0, it is necessary to disable the user account control of Windows 8/Windows 7/Windows Vista. After logging on with the administrator account, follow the procedure below to change the setting:*

#### **[Change Procedure]**

##### **<For Windows 8/Windows 7>**

- 1 Click [Control Panel].**
- 2 Click [User Accounts and Family Safety] (Windows 8 only).**
- 3 Click [User Accounts].**
- 4 Click [Change User Account Control settings].**
- 5 Change [Choose when to be notified about changes to your computer] to [Never notify] and click [OK].**
  - *If restarting is requested, click [Restart now].*

##### **<For Windows Vista>**

- 1 Click [Control Panel] from the Start Menu.**
- 2 Click [User Accounts and Family Safety].**
- 3 Click [User Account].**
- 4 Click [Enable/Disable User Account Control].**
- 5 Remove the checkmark for [Use User Account Control (UAC) to Help Computer Protection] and click [OK].**
  - *If rebooting is requested, click [Reboot Now].*

*Upon completion of Desktop Control Utility, it is recommended to enable the user account control.*

---

### • Operation on computer

- 1 Click **Windows [Start]** → **[All Programs]** → **[NEC Projector User Supportware]** → **[Desktop Control Utility 1.0]** → **[Desktop Control]**, in that order.

The “Selection Of Network Connections” window is displayed.

This displays a list of the network devices connected to the computer you are using.

- 2 Select the network device to use and click **[OK]**.

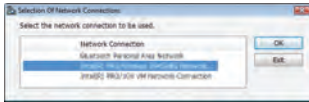

The “Startup password settings” window will be displayed.

- In case of Windows 7/Windows Vista, the User Account Control Window is displayed. Click **[OK]** or input the administrator password.

Screen when Desktop Control Utility 1.0 is started first time      Screen if starting password has been set already

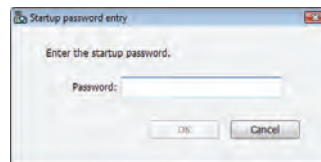

### IMPORTANT:

- Be sure to write down the starting password in case you forget it.
  - The starting password must be input each time Desktop Control Utility 1.0 is started.
  - Should you forget the starting password, reinstall the Desktop Control Utility 1.0.
- A screen like the one below is displayed when the software is started on a PC installed with Windows XP Service Pack 2 (SP2) (or later).
- Click “Unblock” if this is displayed.





### 3 Input the starting password of Desktop Control Utility 1.0, and click [OK].

The "Current password" window will be displayed.

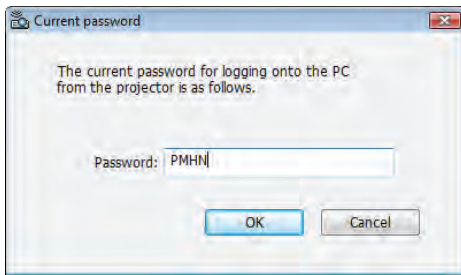

---

#### NOTE:

The character string displayed in the password field varies each time Desktop Control Utility 1.0 is started.

---

### 4 Write down the character string displayed in the password field.

Write down "PMHN" in the screen example of step 3.

### 5 Click [OK].

Desktop Control Utility 1.0 will be started.

Move to the room where the projector is installed, with the paper on which you have written down the password in step 4.

### • Operating the projector (connecting computer)

1 Connect a USB mouse that is commercially available to the projector.

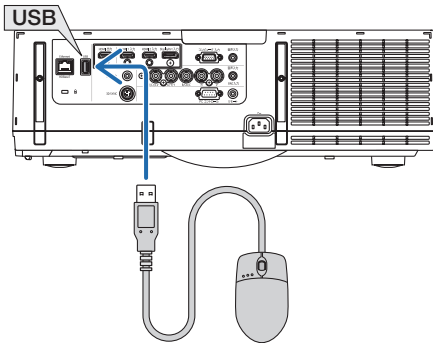

2 Turn on the power to the projector.

Set the LAN setting of the projector in advance.

3 Press the “8/Ethernet” button on the remote control.

The application menu screen will be displayed.



- Press the “INPUT” button briefly to display the input terminal screen for operations on the main body. Press the ▼▲ buttons to select [8:ETHERNET] and then press the “ENTER” button to switch the input and display the application menu screen.
- You can also a USB mouse connected to the projector for subsequent operations.

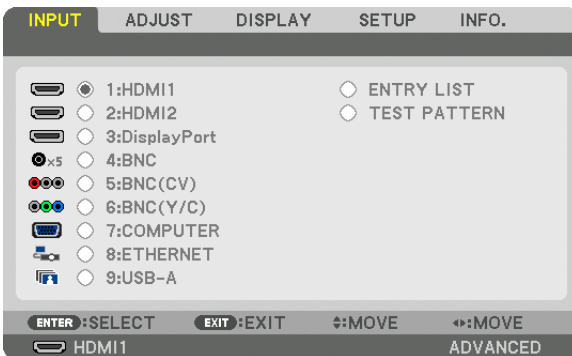

4 Press the **SELECT** ▼/▲ buttons to select **[NETWORK]**, and then press the **ENTER** button.

The “network menu” screen will be displayed.

- The remaining operations can be performed using a USB mouse connected to the projector.



5 Click **[DESKTOP CONTROL UTILITY]**.

The “DESKTOP CONTROL UTILITY menu” screen will be displayed.



6 Click “**ENTRY**”.

A password input screen will be displayed.



7 Input the password you have written down in step 4 of “Operation on computer”.

- Click the **[BS]** button on the right side of the **[PASSWORD]** field to delete the character to the left of the character insertion point.

8 After inputting the password, click the  button on the right side of the **[PASSWORD]** field.

You are returned to the “DESKTOP CONTROL UTILITY” menu screen.

### 9 Click [COMPUTER SEARCH].

The "COMPUTER LIST" screen will be displayed.



If the connection destination has not been found as a result of a COMPUTER SEARCH, search for the connection destination by inputting the IP address of the computer at the connection destination, click "Input IP Address".

### 10 Click the computer at the connection destination and then [OK].

The desktop screen of the computer at the connection destination will be displayed.





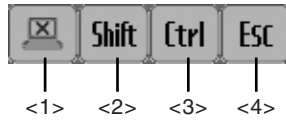

### • Operating the projector (manipulating desktop screen)

The displayed desktop screen can be manipulated by using the USB mouse connected to the projector. If the EXIT button of the projector or remote control is pressed while the desktop screen is displayed, an auxiliary operation bar is displayed at the lower left of the screen.

Manipulate the auxiliary operation bar by using the buttons of the projector or remote control.



- <1>  (cut-off icon)..... Disconnects communication with the computer.
- <2>  (Shift icon)..... When the highlight is moved to this icon and the ENTER button is pressed, shift lock status is set. The shift lock is canceled if the highlight is moved to this icon and the ENTER button is pressed again.
- <3>  (Ctrl icon)..... When the highlight is moved to this icon and the ENTER button is pressed, control lock status is set. The control lock is canceled if the highlight is moved to this icon and the ENTER button is pressed again.
- <4>  (ESC icon)..... The same operation as when the [ESC] key of the computer is pressed is performed. This icon is used, for example, to stop a slideshow of PowerPoint.

### • Operating the projector (disconnecting communications)

#### 1 Press the EXIT button while the desktop screen is displayed.

An auxiliary operation bar will be displayed at the lower left of the screen.



#### 2 Move the highlight to (cut-off icon) and press the ENTER button.

Communication will be disconnected and you are returned to the “DESKTOP CONTROL UTILITY” menu screen.

To resume communication, click [COMPUTER SEARCH].

After that, follow step 10 on the preceding page.

#### REFERENCE:

Communication can also be disconnected by clicking the projector icon on the taskbar and then clicking “Disconnect” while the desktop screen is displayed.

### • Operating the projector (exiting Desktop Control Utility 1.0)

- 1 Click the projector icon [  ] on the taskbar while the desktop screen is displayed.

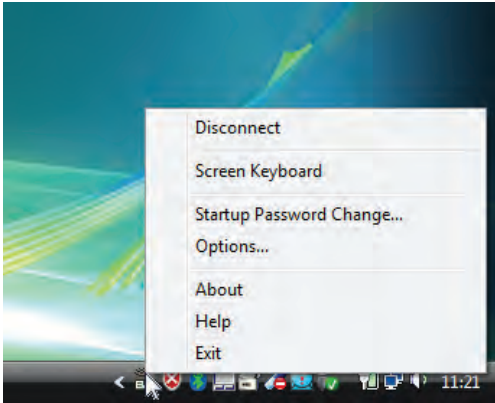

- 2 Click [Exit].  
*Desktop Control Utility 1.0 will be terminated.*
- 3 Press the EXIT button on the projector unit or on the remote control.  
*The "network menu" screen will be displayed.*
- 4 Press the MENU button on the projector unit or on the remote control.  
*The on-screen menu will be displayed.*  
*Select [INPUT TERMINAL] in the sub-menu.*
- 5 Select an input source other than [8:ETHERNET].

# 9. Using the Viewer (MM Models)

## ① What you can do with the Viewer

The Viewer feature allows you to view slides or movie files stored on a USB memory on the projector, or a shared folder in a computer connected to the network.

The Viewer has the following features.

- When a commercially available USB memory that stores image files is inserted into the USB port (Type A) of the projector, the Viewer allows you to view the image files on the USB memory.  
Even if no computer is available, presentations can be conducted simply with the projector.
- Movie file with audio can be played back.
- A Microsoft PowerPoint/Excel file or Adobe PDF file can be simply projected on the screen without connecting a computer.
- Image and movie files stored in a shared folder in a computer connected to a network can be projected.  
The computer with “Media Sharing” of Windows Media Player 11 turned on can be used as a media server.

### Supported graphic formats

Format	File name extension
JPEG	.jpg, .jpe, .jpeg (CMYK is not supported.)
BMP	.bmp (bit field not supported)
PNG	.png (Interlaced PNG and $\alpha$ channel PNG are not supported.)
GIF	.gif (Interlaced GIF, transparation GIF, and animation GIF are not supported.)

\* If an unsupported image is selected, the icon  will be displayed.

#### NOTE:

Maximum number of pixels of image which can be displayed are:

- Baseline JPEG: 10000 × 10000
- Progressive JPEG: 1280 × 1280
- GIF: 1280 × 1280
- Others: 4000 × 4000
- Some files supported by the above requirements may not be displayed.

### Supported movie files

File name extension	Video compression/expansion method	Audio compression/expansion method
.mpg, .mpeg.	MPEG2	MPEG Audio Layer2
		MPEG Audio Layer3
.wmv	WMV9	WMA9 Standard
.mp4	H.264/AVC	AAC-LC

#### Playback requirements:

Resolution: 320 × 240 to 1280 × 720

Video frame rate: up to 30fps

Bitrate: up to 15Mbps

Audio sampling rate: up to 48kHz

Channel: up to 2ch stereo

Audio bit rate: up to 256 Kbps

Max. file size: up to 2GB

**NOTE:**

- *Movie files converted by using the video/audio format which is not supported by this projector cannot be played back. In this case, there will be no icon to show that playback is not possible.*
- *Files with Digital Rights Management(DRM) protection cannot be played back.*
- *Some of the movie files that meet the above requirements may not be played back. Movie files may not be played back correctly depending on your network environment or the bit rate of your file.*
- *WMV format video file will be displayed in an aspect ratio of 1 to 1 independently of its original aspect ratio.*
- *Files that can be played back on the media server are graphics and movie files. In Windows Media Player 11 (Windows XP/Windows Vista) mp4 files cannot be played back.*

### Supported PDF files

File name extension	Supported file format
.pdf	Adobe Acrobat PDF

**NOTE:**

- *Fonts not embedded in PDF may not be displayed*
- *Functions added to PDF file after created will not work or display. Functions added are bookmarks, boxes in form tool, and notes will not be displayed.*  
*Auto flip or Auto transition will not work.*
- *Some PDF files may not be displayed.*

### Supported PowerPoint files

File name extension	Supported file format
.ppt, .pptx	Microsoft PowerPoint 97 – 2007

**NOTE:**

- *Playable fonts, colors, font ornament, placement, object insertion or animation are restricted.*
- *Some Microsoft PowerPoint 97 – 2007 files may not be displayed.*

### Supported Excel files

File name extension	Supported file format
.xls, .xlsx	Microsoft Excel 97-2007

**NOTE:**

- *Playable fonts, colors, font ornament, graphs, or graphics are restricted.*
- *Some Microsoft Excel 97 - 2007 files may not be displayed.*

### Supported USB memory devices

- Be sure to use a USB memory device formatted with the FAT, exFAT, FAT32 or FAT16 file system.  
The projector does not support NTFS formatted USB memory.  
If the projector does not recognize your USB memory, check if the format is supported.  
To format your USB memory in your computer, refer to the document or help file that comes with your Windows.
- We do not warrant that the USB port of the projector will support all USB memories in the market.



### Notices on shared folder and media server

- Files from a shared folder or media server may not be projected if security or antivirus software is installed on your computer.
- Open the following firewall ports:

- Media server

Port number	Protocol
1900	UDP
2869	TCP
10243	TCP
10280-10284	UDP

- Shared folder

Port number	Protocol
137	UDP/TCP
138	UDP/TCP
139	UDP/TCP
445	UDP/TCP

- Set your computer for sharing and security to grant access to files in the shared folder and set your security or antivirus software to grant access to files in the shared folder. Consult your network administrator for more information.
- Movie files in the shared folder or the media server may not be played back correctly depending on your network environment or the bit rate of your file.

---

**NOTE:**

*Do not disconnect between the projector and your computer by removing the LAN cable or turning off the projector when a PowerPoint file or PDF file is displayed from a shared folder. Doing so will make Viewer inoperable.*

---

**NOTE**

- The following operations by using the buttons on the projector are not possible when the VIEWER screen such as the slide screen and the thumbnail screen is displayed.
    - Keystone correction by using the ▲ or ▼ button
    - Auto Adjustment by using the AUTO ADJ. button
    - Volume control with the ◀ or ▶ button
  - Freezing picture by using the FREEZE, ASPECT, or AUTO ADJ. button on the remote control is not possible when the VIEWER screen such as the slide screen and the thumbnail screen is displayed.
  - Executing [RESET] → [ALL DATA] from the menu will return the settings for the Viewer toolbar to the factory default.
-

## 2 Preparing presentation materials

### 1. Create your presentation materials and save them in a supported file format to your computer.

- See page 225 for supported file formats.
- Make sure that PowerPoint file is displayed on the Viewer before giving your real presentation.
- When creating a PDF file, embed your fonts in your PDF file. Embedding fonts requires Adobe Acrobat. This cannot be done in Adobe Reader.

TIP:

#### • Using Print Command

Example for font embedding using Print Command. See the help of Adobe Acrobat for more information.

##### 1. Select “Print” from the “File” menu.

##### 2. Select “Adobe PDF” from “Printer name” and click the “Properties” button.

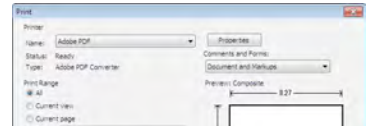

##### 3. Click the “Edit” button in the “Adobe PDF Settings” tab.

##### 4. Click the font tab in the Edit window to select the font embed window.



##### 5. Place a check mark for “Embed all fonts”.

Click “OK” to return to the Print window, and click “OK” to start creating a PDF file.

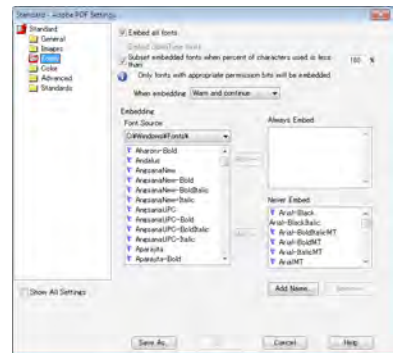

### 2. Save a file to your drive.

To save a file to your USB memory:

Use the Windows Explore to copy the file to your USB memory.

To place a file in a shared folder you create in your computer, see page 243.

To use “Media Sharing” in Windows Media Player 11, see page 247.

### 3 Projecting images stored in a USB memory device

This section explains the basic operation of the Viewer.

The explanation provides the operational procedure when the Viewer toolbar is set to the factory default.

Preparation: Before starting the Viewer, store images to the USB memory using your computer.

#### Starting the Viewer

1. Turn on the projector. (→ page 16)
2. Insert the USB memory into the USB port of the projector.

**NOTE:**

- Do not remove the USB memory from the projector while its LED flashes. Doing so may corrupt the data.

**TIP:**

You can a USB memory insert the projector when the drive list screen is displayed.

3. Press the “9/USB-A” button.

The screen will change to the viewer display and a screen showing a list of the drives will be displayed after 2 to 3 seconds.

**TIP:**

- Press the button to display the viewer with the main body operation. Refer to page 18 for the selection method.
- For more information about the drive list screen, see page 235.
- To display graphics in a shared folder, see page 243; to display still images or movie files in a media server, see page 247.

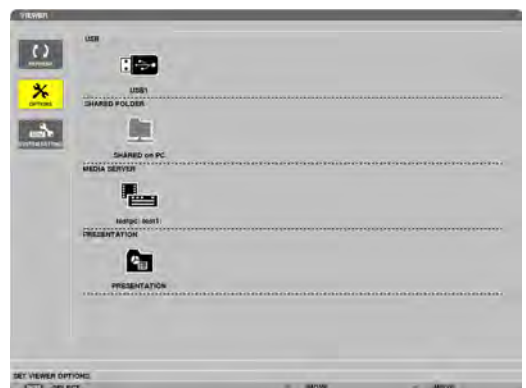
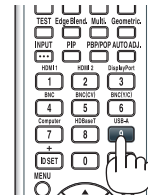
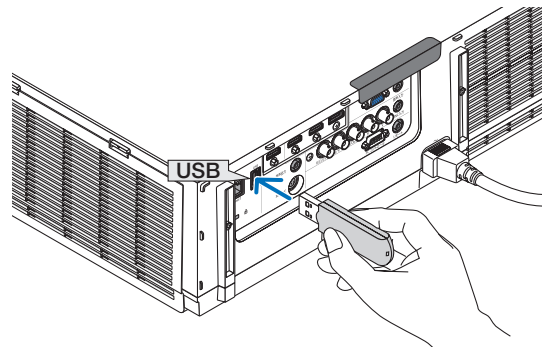

## 9. Using the Viewer (MM Models)

4. Press the **▶** button to select “USB1” and press the **ENTER** button.

The “USB1” thumbnail screen will be displayed.

TIP:

- For more information about thumbnail screen, see page 237.

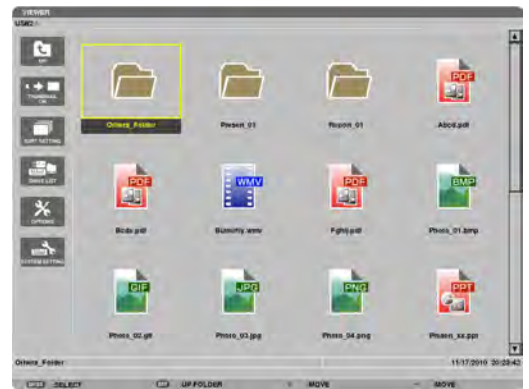

5. Use the **▲▼◀▶** or **▶** button to select an icon.

- The **→** (arrow) symbol on the right indicates there are more pages. pressing the **CTL + ▼** (page down) button will show the next page: pressing the **CTL + ▲** (page up) button will show the previous page.

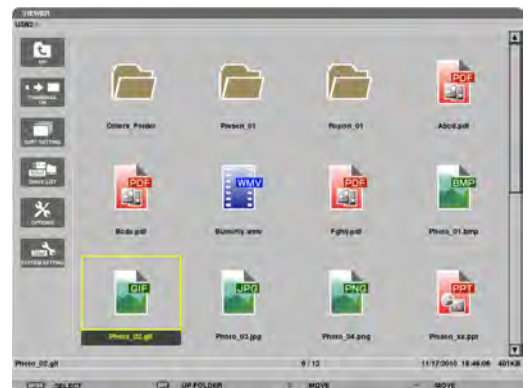

6. Press the **ENTER** button.

Operation varies depending on the selected file.

### • Still image

The selected slide will be displayed.

The **◀** or **▶** button can be used to select the next (right) slide or the previous (left) slide in the thumbnail screen.

- Pressing the **ENTER** button will display the control bar with which is used to select or rotate an slide.(→ page 240)



## 9. Using the Viewer (MM Models)

### • **Movie file**

The movie file will start playing.

After finishing the playback, the screen will turn to black. Press the EXIT button to return to the thumbnail screen.

- Pressing the ENTER button will display the movie's control bar with which you can pause or fastforward and some other operations.

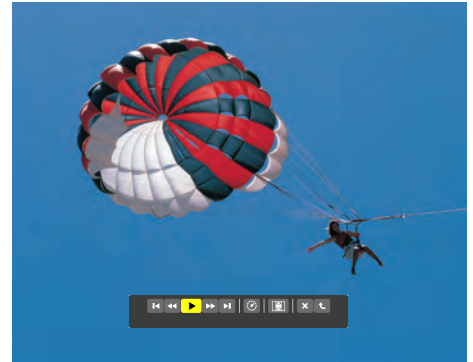

### • **Microsoft PowerPoint/Excel file**

[PowerPoint]

The slide on the first page will be displayed.

Press ► to select the next slide; press ◀ to select the previous slide.

- You can also use the ▼ or ▲ button to select a page. To return to the thumbnail screen, press the EXIT button.

Domestic Shipments of Product

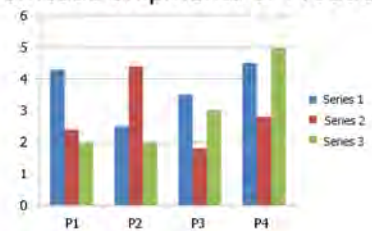

[Excel]

The first sheet will be displayed.

Pressing the ▲, ▼, ◀, or ► button to scroll the sheet up, down, left and right.

The CTL + ▼ or CTL + ▲ button will move to the next sheet or the previous sheet.

Pressing the ENTER button will change the display ratio in the sheet.

To return to the thumbnail screen, press the EXIT button.

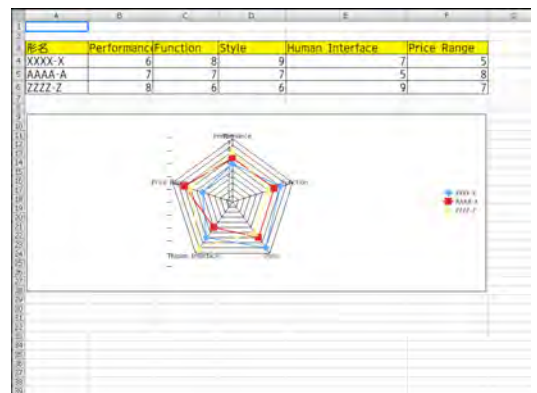

### NOTE:

- Files with slideshow or animation effects may not be correctly displayed on the Viewer.  
See "Supported PowerPoint files"/"Supported Excel files" on page 226.

## 9. Using the Viewer (MM Models)

- **Adobe PDF file**

The first page will be displayed.

- The PDF file will fill the width of the screen.

Pressing the ▼ or ▲ button will scroll the screen down or up.

The CTL + ▼ or CTL + ▲ button will move the screen one page down or up.

To return to the thumbnail screen, press the EXIT button.

Pressing the ENTER button will change the display mode between whole screen and part screen.

- When a password input window is displayed, it means that the PDF file is password-protected.

Pressing the ENTER button will show the software keyboard. Use the software keyboard to enter your password.

Select [OK] and press the ENTER button. The PDF file will be displayed.

- For more information on the software keyboard, see page 151.

---

### NOTE:

Bookmarks and notes that were added after PDF conversion will not be displayed.

If fonts were not embedded at the time of PDF conversion, those fonts will not be displayed.

---

### TIP:

It takes some time (about 30 seconds to two minutes) to display a large size file or to turn pages of a PDF file that has many pages.

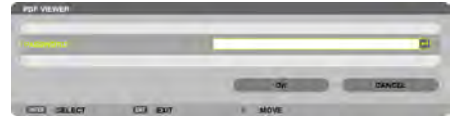
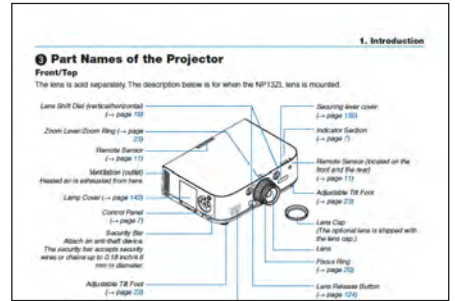

- **Index file (extension:.idx)**
- Index files, which is converted by using Viewer PPT Converter 3.0, will appear in the Thumbnail screen.  
Only folders and JPEG files converted by using Viewer PPT Converter 3.0 will appear in the Thumbnail screen.  
*TIP:*
  - Viewer PPT Converter 3.0 can be downloaded from our website.  
URL: <http://www.nec-display.com/dl/en/index.html>
- To select slideshow of index files, open the [PRESENTATION] folder in the DRIVE LIST screen.  
However, index files will not appear. Only folders and JPEG files will appear.
- Up to four index folders in your USB and shared folder are displayed. The four folders will be displayed in reverse chronological order
- When you insert the USB memory device storing index with the Viewer in operation, the content of the index files will be displayed.



---

**NOTE:**

- The play mode (MANUAL/AUTO) for slides of index file works in the following way:  
In case of [MANUAL] for [PLAY MODE]  
When you select [OPTIONS] → [SLIDE SETTING] → [PLAY MODE] → [MANUAL], index files will be set for manual playback in regardless of whether [INTERVAL] is set.  
In case of [AUTO] selected for [PLAY MODE]  
When you select [OPTIONS] → [SLIDE SETTING] → [PLAY MODE] → [AUTO], index files will be set for auto playback at intervals specified by using [INTERVAL].  
When, however, [-1] is selected for [INTERVAL], the play mode will be set for auto playback according to the setting for [OPTIONS] → [SLIDE SETTING] → [INTERVAL].

---

**7. Remove the USB memory from the projector.**

Return to the drive list screen. Make sure that the LED on the USB memory is not flashing before removing the USB memory.

---

**NOTE:** If you remove the USB memory from the projector with a slide displayed, the projector may not operate correctly. If this happens, turn off the projector and unplug the power cord. Wait 3 minutes, then connect the power cord, and turn on the projector.

---

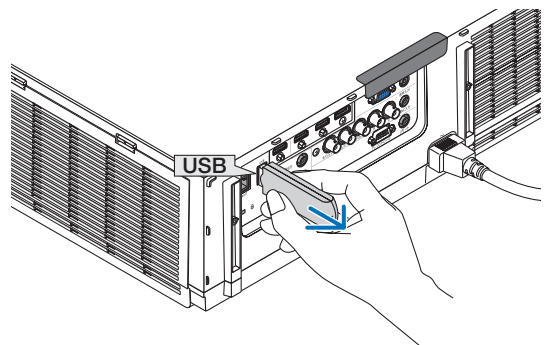



### Exiting the Viewer

1. Press the “INPUT” button on the remote control and select an input terminal other than “USB-A”.
  - When operating with the main body, use the “INPUT” button to select an input terminal other than [9:USB-A].

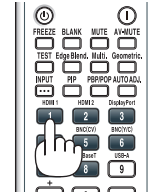



### Names and functions of Viewer screen

The Viewer has three screens: Drive list screen, Thumbnail screen, and Slide screen.

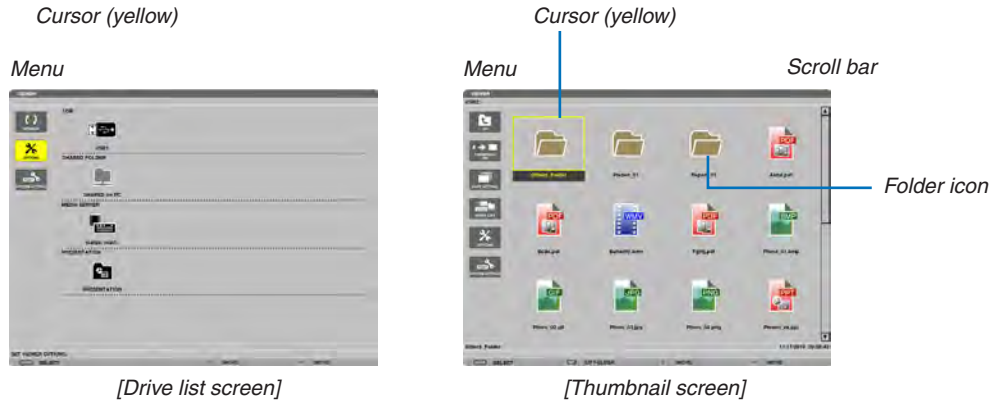

Path information



Drive information/File information



Menu guide

Operation button guide



[Slide screen]

Control bar

\* The operation for still image differs from that for movie.

#### • Drive list screen

Displays a list of drives connected to the projector.

#### Menu operation

- Use the ▼ or ▲ button to move the cursor up or down. Select the menu item and press the ENTER button to display the submenu.

#### Operation for Drive list screen













1. Press the ► button to move the cursor to the drive list.

(Use the ◀ or ▶ button to switch between the menu and the drive list.)

Press the ▼ or ▲ button to select a type of drive; press the ◀ or ▶ button to select the drive connected to the projector.

2. Select the drive and press the ENTER button to switch to the thumbnail screen of the selected drive.

Functions

Name	Description
 REFRESH	Displays additional media servers in the drive list screen.
 OPTIONS	Opens the OPTIONS menu.
 SLIDE SETTING	Sets up slides. (→ page 240)
 MOVIE SETTING	Sets up movie files. (→ page 241)
 AUTO PLAY SETTING	Sets up auto play. (→ page 241)
 SHARED FOLDER	Sets up a shared folder. (→ page 243)
 MEDIA SERVER	Sets up a media server. (→ page 247)
 RETURN	Closes the OPTIONS menu.
 SYSTEM SETTING	Switches to the system setting menu. See wired LAN, wireless LAN, WPS, network information, and keyboard in “9. Application Menu”. (→ page 138)
 USB	Displays the icon for a USB memory inserted into the USB port of the projector.
 SHARED FOLDER	Displays up to four drives of a computer connected to a LAN (set for connecting a shared folder). * See page 243 for setting up for connecting a shared folder of the projector.
 MEDIA SERVER	Displays up to four drives of a computer connected to a LAN (set for connecting a media server). * See page 247 for setting up for connecting a media server of the projector
 PRESENTATION	Displays the icon when a USB memory or shared folder stores index files.
Path information	Displays the location of a folder or file.
Drive information	[Example]  <div style="display: flex; justify-content: space-around; align-items: center;"> <div style="text-align: center;"> <p><u>USB1</u></p> <p>↓</p> <p>Displays the drive.</p> </div> <div style="text-align: center;"> <p><u>314MB FREE/492MB</u></p> <p>↓</p> <p>Displays free space and capacity of a drive.* (USB only)</p> </div> </div>
Menu guide	Displays the description of a selected menu.
Operation button guide	Displays information about operation buttons.

\* It is displayed in three-digit number (rounding up)

NOTE:

When the OPTIONS menu is displayed, the drive list screen or thumbnail screen is not displayed. To display it, select the [RETURN] icon and press the ENTER button.

### • Thumbnail screen

Displays a list of folders, thumbnails, and icons in the drive selected on the drive list screen.







### Menu operation

- Use the ▼ or ▲ button to move the cursor up or down. Select the menu item and press the ENTER button to display the menu or setting screen.

### Operation for Thumbnail screen

1. Press the ► button to move the cursor to the thumbnail screen when the OPTIONS menu is not displayed.
2. Press the ▼, ▲, ◀, or ▶ button to select a file or folder.
3. Press the ENTER button to start slideshow or playback of the selected file. Selecting a folder will display its thumbnail screen.

### Functions

Name	Description								
 UP	Goes to one upper level menu.								
 THUMBNAIL ON	Switches two displays between thumbnail and icon.								
 SORT SETTING	Rearranges folders or files.								
 DRIVE LIST	Returns to the drive list screen.								
 OPTIONS	Changes to the OPTIONS menu.								
 SYSTEM SETTING	Opens the system setting menu.								
Scroll bar	Thumbnail screen will display 12 files with 4 by 3. If the thumbnail screen has twelve or more files or folders, the scroll bar will be displayed at the right side. Using the CTL + ▼ or CTL + ▲ button will scroll the whole screen down or up.								
Path information	Displays the location of a folder or file.								
Thumbnail information	<p>[Example]</p> <table style="width: 100%; border-collapse: collapse;"> <tr> <td style="text-align: center; border-bottom: 1px solid black;"><u>005.jpg</u></td> <td style="text-align: center; border-bottom: 1px solid black;"><u>5/200</u></td> <td style="text-align: center; border-bottom: 1px solid black;"><u>11/03/2010 13:25:12</u></td> <td style="text-align: center; border-bottom: 1px solid black;"><u>502KB</u></td> </tr> <tr> <td style="text-align: center;">Selected folder name or file name</td> <td style="text-align: center;">Numbers and order of files in a folder (only when folder selected)</td> <td style="text-align: center;">Create/Change date: M/D/Y/H/M/B</td> <td style="text-align: center;">Displays file capacity</td> </tr> </table>	<u>005.jpg</u>	<u>5/200</u>	<u>11/03/2010 13:25:12</u>	<u>502KB</u>	Selected folder name or file name	Numbers and order of files in a folder (only when folder selected)	Create/Change date: M/D/Y/H/M/B	Displays file capacity
<u>005.jpg</u>	<u>5/200</u>	<u>11/03/2010 13:25:12</u>	<u>502KB</u>						
Selected folder name or file name	Numbers and order of files in a folder (only when folder selected)	Create/Change date: M/D/Y/H/M/B	Displays file capacity						
Menu guide	Displays the description of a selected menu.								
Operation button guide	Displays information about operation buttons.								

### TIP:

- If an unsupported image is selected, the icon [?] will be displayed,
- The maximum displayable number of images is 300 in the thumbnail screen including the number of folders.
- If a file name or path of a folder is longer than specified, it will be displayed with center characters or path skipped.  
Example: "123456789.jpg" will be displayed in "123..789.jpg".

### • Slide screen (still image/movie)

Plays a file selected from a list of thumbnails or icons.

- For operating a Microsoft PowerPoint file and Adobe PDF file, see page [231](#), [232](#).

### Control bar operation

- The control bar will be displayed only when a still image (or index file) and a movie file is selected.
- The control bar for still images differs from that for movie files.

**1. Pressing the ENTER button in Slide screen will display the control bar at the bottom of the screen.**

**2. Use the ◀ or ▶ button to select a file and press the ENTER button.**

- The selected function will be executed.











### Functions of still image control bar



Name	Description	
PREV	Goes back to the previous image	
PLAY	Plays the image. This button also is used to stop or start playing an image.	
NEXT	Goes to the next image.	
RIGHT	Rotates the image 90° clockwise. • To cancel, select another folder.	
LEFT	Rotates the image 90° counter clockwise. • To cancel, select another folder.	
SIZE	BEST FIT	Displays the image with its aspect ratio in the projector's displayable maximum resolution.
	ACTUAL SIZE	Displays the image in its actual size.
CLOSE	Closes the control bar. • You can also press the EXIT button to close the control bar.	
END	Stops playing slides or slideshow, and closes the control bar to return to the thumbnail screen.	

Functions of movie control bar



Name	Description	
 PREV	Goes back to the beginning of a movie file. <ul style="list-style-type: none"> <li>• Goes back to the beginning of the previous movie file if executed immediately after being started playing.</li> </ul>	
 FR	Fast-rewinds a movie file for about 7 seconds.	
PLAY/PAUSE	 PLAY	Plays a movie file.
	 PAUSE	Stops playing a movie file.
 FF	Fast-forwards a movie file for about 7 seconds.	
 NEXT	Goes to the beginning of a next movie file.	
 TIME	Displays an elapsed time for playback or pause.	
SIZE	 BEST FIT	Displays the image with its aspect ratio in the projector's displayable maximum resolution.
	 ACTUAL SIZE	Displays the image in its actual size.
 CLOSE	Closes the control bar. <ul style="list-style-type: none"> <li>• You can also press the EXIT button to close the control bar.</li> </ul>	
 END	Stops playing a movie, and closes the control bar to return to the thumbnail screen.	

**Viewer option settings**

• **SLIDE SETTING**

Sets still images or slides.



Name	Options	Description
SCREEN SIZE	BEST FIT	Displays the image with its aspect ratio in the projector's displayable maximum resolution.
	ACTUAL SIZE	Displays the image in its actual size.
PLAY MODE	MANUAL	Selects manual play.
	AUTO	Selects auto play.
INTERVAL	5 - 300 seconds	Specifies interval time when [AUTO] is selected for PLAY MODE.
REPEAT	Check mark	Turns on or off the repeat function.

*TIP*

- *To play one or more slides, place those files into a folder.*

### • MOVIE SETTING

Sets the functions for a movie file.

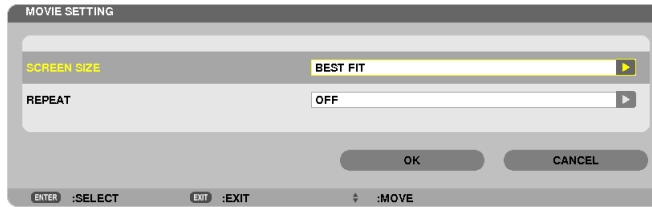

Name	Options	Description
SCREEN SIZE	BEST FIT	Displays the image with its aspect ratio in the projector's displayable maximum resolution.
	ACTUAL SIZE	Displays the image in its actual size.
REPEAT	OFF	Turns on or off the repeat function.
	ONE REPEAT	Repeats one file only.
	ALL REPEAT	Repeats all files in the current folder.

#### TIP

- Turning on [REPEAT] will display black screen during intermission between movies.

### • AUTO PLAY SETTING

Sets auto play for slideshow when a USB memory device is inserted into the USB port of the projector, or when [VIEWER] is selected for [SOURCE].

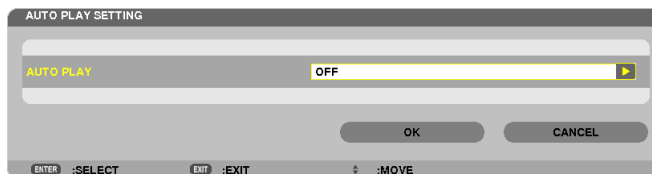

Name	Options	Description
AUTO PLAY	OFF	—
	PICTURE	Plays a first found still image in a drive.
	MOVIE	Plays a first found movie file in a drive.
	PowerPoint	Plays a first found PowerPoint file in a drive.

#### TIP

- Auto play behavior is different between when a USB memory device is inserted into the USB port of the projector and when [VIEWER] is selected for [SOURCE].
- Auto play starts for the first found file supporting the file type set up for Auto Play. The file will be searched in the drive root or lower level.
- When [VIEWER] is selected for [SOURCE], the last selected file will be automatically played if it is found, or the last selected folder will be searched and the first found file will be automatically played.  
To automatically play a movie file in a USB memory, store one movie file or change its file name so that it can be searched first.

### • SORT SETTING

Sets the order of displaying thumbnails or slides.

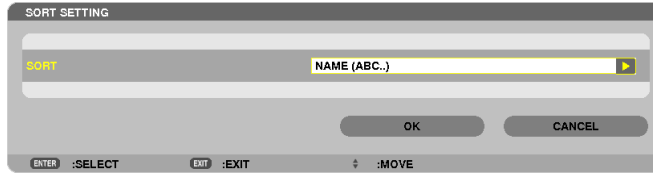

Name	Options	Description
SORT	NAME (ABC..)	Displays the files alphabetically by name in ascending order.
	NAME (ZYX..)	Displays the files alphabetically by name in descending order.
	EXT. (ABC..)	Displays the files alphabetically by extension in ascending order.
	EXT. (ZYX..)	Displays the files alphabetically by extension in descending order.
	DATE (NEW)	Displays the files in reverse chronological order.
	DATE (OLD)	Displays the files in chronological order.
	SIZE (BIG)	Displays the files in descending order of its file size.
	SIZE (SMALL)	Displays the files in ascending order of its file size.



## ④ Projecting data from shared folder

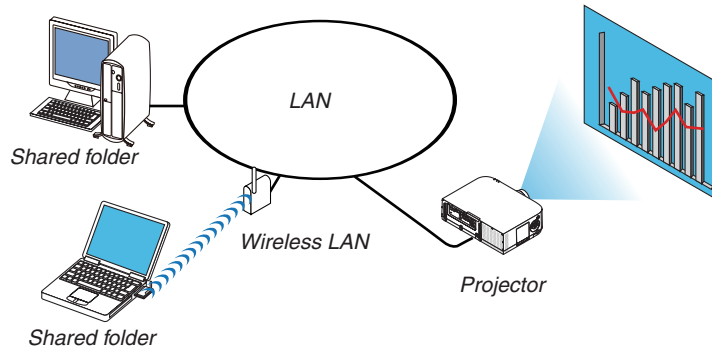

### Preparation

For projector: Connect the projector to the network.

For computer: Place files to be projected in a shared folder and note the folder's path. Memorize or write down the path for later use.

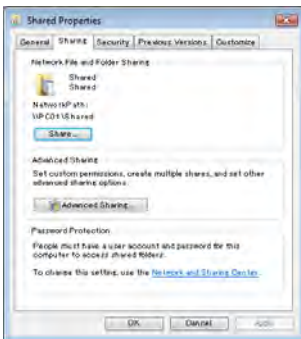

- For sharing a folder, refer to your user guide or help file accompanied with your Windows computer.
- Use a keyboard to give a name to the shared folder in alphanumeric characters.
- To connect the shared folder beyond the subnet, set [WINS CONFIGURATION] in [NETWORK SETTINGS] from the menu.
- Digital signature (SMB signature) is not supported.

### Connecting the projector to the shared folder

#### 1. Press the 9/USB-A button on the remote control.

The drive list window will be displayed.



- When operating with the main body, use the "INPUT" button to select [9:USB-A].

### 2. Displays the [OPTIONS] menu.

Press the ▼ button to select the  (OPTIONS) icon and press the ENTER button.



- When the OPTIONS menu is displayed, the drive list will not be displayed.

### 3. Display the [SHARED FOLDER] screen.

Press the ▼ button to select the  (SHARED FOLDER) icon and press the ENTER button.



### 4. Select a folder number and place to enable it.

Press the ◀ or ▶ button to a shared folder number and press the ▼ button to select [ENABLE], and then press the ENTER button.



### 5. Enter the path, user name, and password for the shared folder.

Press the ▼ button to select the [SHARED FOLDER] field. The software keyboard will be displayed.

For using the software keyboard, see page 151.

- If your computer is not password protected, entering a password is not required.
- Up to four shared folders can be added.
- The maximum length of a path of the shared folder must be 15 alphanumeric characters for computer name and 23 alphanumeric characters for folder name.



### 6. Exit the setting.

Press the ▼ button to select [OK] and press the ENTER button.

This will close the [SHARED FOLDER] screen.

- If an error message appear, your settings are not correct. Try again.



### Disconnecting the shared folder from the projector

- **Disable the number of a shared folder you wish to disconnect**

Press the ▼ button to select [ENABLE] and press the ENTER button to clear it.

---

#### NOTE:

- When a PowerPoint file or PDF file is displayed, do not disconnect your LAN cable. If doing so, the Viewer will not work.
- 



#### TIP:

- **Connecting settings for Shared folder**  
Settings of up to four folders can be saved.  
Restarting the projector will display setting-saved shared folders in grey folder icon on the drive list screen.  
Selecting the grey icon folder will skip entry for a folder path.
- Failing to connect with a shared folder will display the folder icon with "x" mark. If this happen, check your folder setting.

## 5 Projecting data from media server

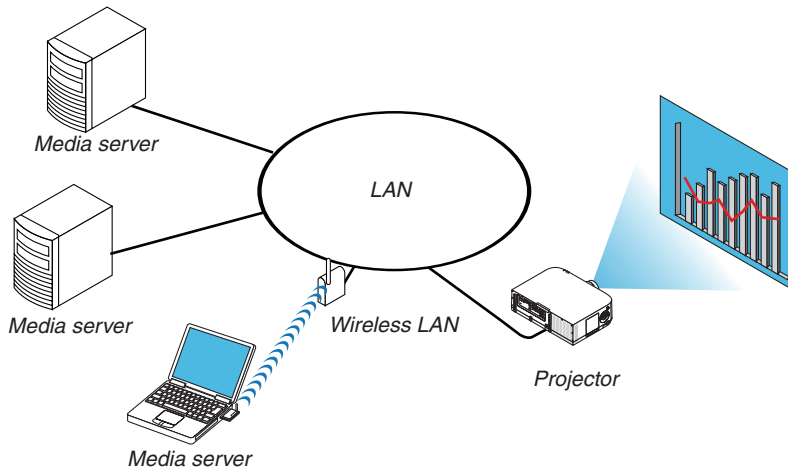

### Preparation

For projector: Connect the projector to the network.

For computer: Prepare image files or movie files to be projected, and set up “Media Sharing” in Windows Media Player 11 or Windows Media Player 12.

### NOTE:

- Both the projector and the media server must be on the same subnet. Connecting to the media server beyond the subnet is not possible.
- Types of images and movies which can be shared may vary depending on Windows version.

## Setting up “Media Sharing” in Windows Media Player 11

1. Start Windows Media Player 11.
2. Select “Media Sharing” from “Library”.

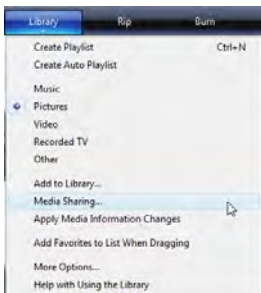

The “Media Sharing” dialog box will be displayed.

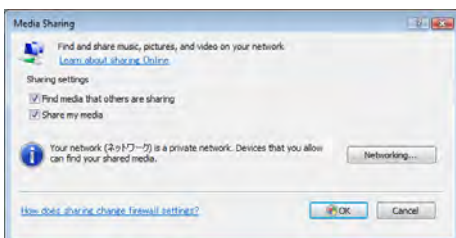

3. Select “Share my media” check box, and then select OK.

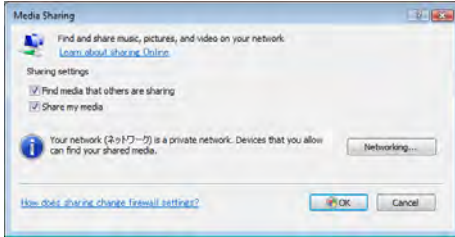

A list of accessible devices will be displayed.

4. Select “6762WU Series” and then “Allow”.



A check mark will be added to the “6762WU Series” icon.

- The “6762WU Series” is a projector name specified in [NETWORK SETTINGS].

5. Select “OK”.



This will make pictures and video in “Library” available from the projector.

### Setting up “Media Sharing” in Windows Media Player 12

#### 1. Start Windows Media Player 12.

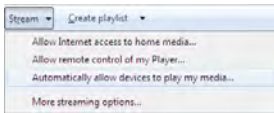

#### 2. Select “Stream”, and then select “Automatically allow devices to play my media”.

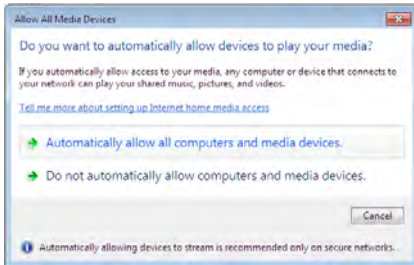

The “Allow All Media Devices” windows will be displayed.

#### 3. Select “Automatically allow all computers and media devices”.

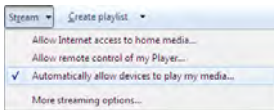

Graphics and movie files in “Library” can be used from the projector.

### Connecting the projector to the media server

Press the 9/USB-A button on the remote control.  
The VIEWER will start.

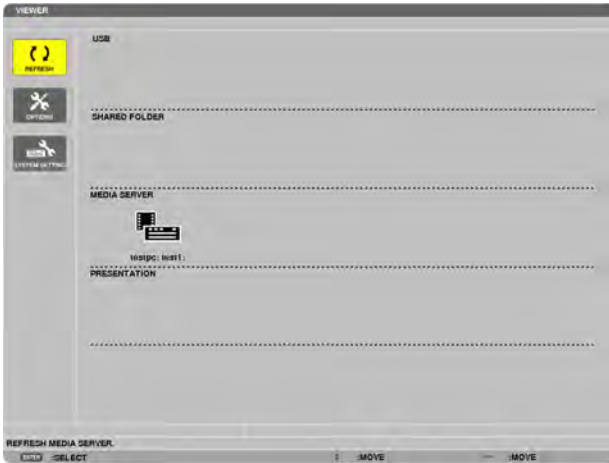

- When operating with the main body, use the “INPUT” button to select [9:USB-A].
- This will start searching for a computer with “media sharing” enabled in the network and add it to the “Media server” of the thumbnail screen.

Another way to do this is to point the cursor to “Media server” and select [REFRESH] from the thumbnail menu and press the ENTER button.

---

#### NOTE:

- *Up to four accessible media servers can be automatically searched and displayed. The fifth device or later cannot be displayed.*
- 

(→ page [229](#))



### Disconnecting the projector from the media server

1. Display the **OPTIONS** menu.

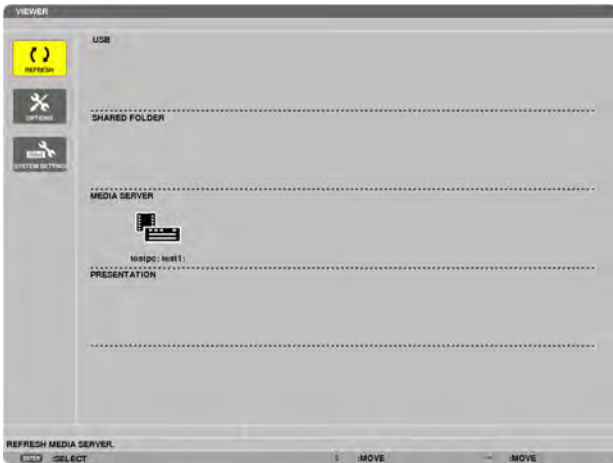

Press the ▼ button to select the [OPTIONS] icon and select the ENTER button.

2. Display the **MEDIA SERVER** setting screen.



Press the ▼ button to select the MEDIA SERVER icon and press the ENTER button.

3. Disable the connection.

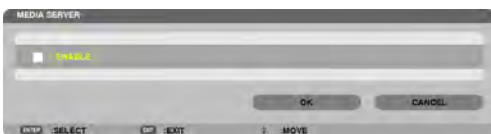

Press the ENTER button to clear the checkmark to disable the connection.

Press the ▼ button to select [OK] and press the ENTER button to close the MEDIA SERVER setting screen.

### 6 Restrictions on displaying files

The Viewer allows you to give a simplified display of a PowerPoint file or PDF file.

Due to simplified display, however, actual display may be different from the one on your computer application program.

#### Some restrictions on PowerPoint files

- Fonts will be automatically converted to the fonts installed in the projector. Fonts can vary in size or width, causing layout corruption  
Some characters or fonts may not be displayed.
- Some functions included in font are not supported.  
Example: There are some restrictions on animation, selection, or hyperlink.
- It may take longer time to feed pages compared with a computer
- In some cases Microsoft PowerPoint 97-2007 format files may not be displayed.

#### Some restrictions on Excel files

- Fonts will be automatically converted to the fonts installed in the projector. Fonts can vary in size or width, causing layout corruption  
Some characters or fonts may not be displayed.
- Some functions included in font are not supported.
- There are some restrictions on graphs, graphics, or images.
- A focus cursor in cell A1 cannot be moved.
- It may take longer time to feed pages compared with a computer
- In some cases Microsoft Excel 97-2007 format files may not be displayed.

#### Some restrictions on PDF files

- Fonts not embedded at the time of PDF creation may not be displayed.
- Some functions included in font are not supported.  
Example: There are some restrictions on annotations, selection, form, or color space.
- It may take longer time to feed pages compared with a computer
- In some cases Adobe Acrobat format files may not be displayed.

# 10. Appendix

## ① Throw distance and screen size

Six separate bayonet style lenses can be used on this projector. Refer to the information on this page and use a lens suited for the installation environment (screen size and throw distance). For instructions on mounting the lens, see page 155.

### Lens types and throw distance

#### WUXGA Type

Screen size	Lens model name					
	NP11FL	NP30ZL	NP12ZL	NP13ZL	NP14ZL	NP15ZL
30"			0.7 - 0.9			
40"	0.7		1.0 - 1.3	1.2 - 2.5		
60"	1.0	1.0 - 1.3	1.5 - 1.9	1.9 - 3.8	3.7 - 6.0	5.9 - 9.0
80"	1.4	1.4 - 1.8	2.0 - 2.6	2.5 - 5.1	5.0 - 8.0	7.9 - 12.1
100"	1.7	1.7 - 2.2	2.5 - 3.3	3.2 - 6.3	6.3 - 10.1	9.9 - 15.1
120"	2.1	2.0 - 2.7	3.0 - 3.9	3.8 - 7.6	7.5 - 12.1	11.9 - 18.2
150"	2.6	2.6 - 3.4	3.8 - 4.9	4.8 - 9.5	9.4 - 15.2	14.9 - 22.8
200"		3.4 - 4.5	5.1 - 6.6	6.4 - 12.7	12.6 - 20.3	20.0 - 30.5
240"		4.1 - 5.4	6.1 - 7.9	7.6 - 15.3	15.2 - 24.4	24.0 - 36.6
300"		5.2 - 6.8	7.6 - 9.9	9.6 - 19.1	19.0 - 30.5	30.1 - 45.8
400"		6.9 - 9.0	10.2 - 13.2	12.8 - 25.5	25.4 - 40.7	40.1 - 61.1
500"		8.7 - 11.3	12.7 - 16.5	16.0 - 31.9	31.8 - 50.9	50.2 - 76.4

#### TIP

Calculation of the throw distance from the screen size

NP11FL lens throw distance (m) =  $H \times 0.8$  : 0.7 m (min.) to 2.6 m (max.)

NP30ZL lens throw distance (m) =  $H \times 0.8$  to  $H \times 1.0$  : 1.0 m (min.) to 11.3 m (max.)

NP12ZL lens throw distance (m) =  $H \times 1.2$  to  $H \times 1.5$  : 0.7 m (min.) to 16.5 m (max.)

NP13ZL lens throw distance (m) =  $H \times 1.5$  to  $H \times 3.0$  : 1.2 m (min.) to 31.9 m (max.)

NP14ZL lens throw distance (m) =  $H \times 2.9$  to  $H \times 4.7$  : 3.7 m (min.) to 50.9 m (max.)

NP15ZL lens throw distance (m) =  $H \times 4.6$  to  $H \times 7.1$  : 5.9 m (min.) to 76.4 m (max.)

"H" (Horizontal) refers to the screen width.

\* Figures differ by several % with the table above because the calculation is approximate.

Ex.: Throw distance when projecting on a 150" screen with the WUXGA Type using the NP13ZL lens:

According to the "Screen Size (for reference)" table (→ page 256), H (screen width) = 323.1 cm.

The throw distance is  $323.1 \text{ cm} \times 1.5$  to  $323.1 \text{ cm} \times 3.0 = 484.7 \text{ cm}$  to 969.3 cm (because of the zoom lens).

## WXGA Type

Screen size	Lens model name					
	NP11FL	NP30ZL	NP12ZL	NP13ZL	NP14ZL	NP15ZL
30"			0.7 - 1.0			
40"	0.7		1.0 - 1.3	1.2 - 2.5		
60"	1.0	1.0 - 1.3	1.5 - 2.0	1.9 - 3.8	3.7 - 6.0	5.9 - 9.1
80"	1.4	1.4 - 1.8	2.0 - 2.6	2.5 - 5.1	5.0 - 8.1	7.9 - 12.1
100"	1.7	1.7 - 2.2	2.5 - 3.3	3.2 - 6.4	6.3 - 10.1	9.9 - 15.2
120"	2.1	2.0 - 2.7	3.0 - 4.0	3.9 - 7.7	7.6 - 12.2	12.0 - 18.3
150"	2.6	2.6 - 3.4	3.8 - 5.0	4.8 - 9.6	9.5 - 15.3	15.0 - 22.9
200"		3.4 - 4.5	5.1 - 6.6	6.4 - 12.8	12.7 - 20.4	20.1 - 30.6
240"		4.1 - 5.4	6.1 - 8.0	7.7 - 15.4	15.3 - 24.5	24.1 - 36.8
300"		5.2 - 6.8	7.7 - 10.0	9.6 - 19.2	19.1 - 30.7	30.2 - 46.0
400"		6.9 - 9.0	10.2 - 13.3	12.8 - 25.7	25.5 - 40.9	40.4 - 61.4
500"		8.7 - 11.3	12.8 - 16.7	16.0 - 32.1	31.9 - 51.2	50.5 - 76.9

## TIP

Calculation of the throw distance from the screen size

NP11FL lens throw distance (m) =  $H \times 0.8$  : 0.7 m (min.) to 2.6 m (max.)

NP30ZL lens throw distance (m) =  $H \times 0.8$  to  $H \times 1.0$  : 1.0 m (min.) to 11.3 m (max.)

NP12ZL lens throw distance (m) =  $H \times 1.2$  to  $H \times 1.5$  : 0.7 m (min.) to 16.7 m (max.)

NP13ZL lens throw distance (m) =  $H \times 1.5$  to  $H \times 3.0$  : 1.2 m (min.) to 32.1 m (max.)

NP14ZL lens throw distance (m) =  $H \times 2.9$  to  $H \times 4.7$  : 3.7 m (min.) to 51.2 m (max.)

NP15ZL lens throw distance (m) =  $H \times 4.6$  to  $H \times 7.1$  : 5.9 m (min.) to 76.9 m (max.)

"H" (Horizontal) refers to the screen width.

\* Figures differ by several % with the table above because the calculation is approximate.

Ex.: Throw distance when projecting on a 150" screen with the WXGA Type using the NP13ZL lens:

According to the "Screen Size (for reference)" table (→ page 256), H (screen width) = 323.1 cm.

The throw distance is  $323.1 \text{ cm} \times 1.5$  to  $323.1 \text{ cm} \times 3.0 = 484.7 \text{ cm}$  to  $969.3 \text{ cm}$  (because of the zoom lens).

## XGA Type

Screen size	Lens model name					
	NP11FL	NP30ZL	NP12ZL	NP13ZL	NP14ZL	NP15ZL
30"			0.7 - 0.9			
40"	0.6		0.9 - 1.2	1.2 - 2.4		
60"	1.0	1.0 - 1.3	1.4 - 1.9	1.8 - 3.7	3.6 - 5.8	5.7 - 8.7
80"	1.3	1.3 - 1.7	1.9 - 2.5	2.4 - 4.9	4.8 - 7.8	7.6 - 11.6
100"	1.6	1.6 - 2.1	2.4 - 3.2	3.0 - 6.1	6.0 - 9.7	9.6 - 14.6
120"	2.0	2.0 - 2.6	2.9 - 3.8	3.7 - 7.4	7.3 - 11.7	11.5 - 17.6
150"	2.5	2.5 - 3.2	3.7 - 4.8	4.6 - 9.2	9.1 - 14.7	14.4 - 22.0
200"		3.3 - 4.3	4.9 - 6.4	6.1 - 12.3	12.2 - 19.6	19.3 - 29.4
240"		4.0 - 5.2	5.9 - 7.7	7.4 - 14.8	14.7 - 23.6	23.2 - 35.3
300"		5.0 - 6.5	7.4 - 9.6	9.2 - 18.5	18.4 - 29.5	29.1 - 44.2
400"		6.7 - 7.7	9.8 - 12.8	12.3 - 24.7	24.6 - 39.4	38.8 - 59.0
500"		8.4 - 10.9	12.3 - 16.0	15.4 - 30.8	30.7 - 49.2	48.6 - 73.8

## TIP

Calculation of the throw distance from the screen size

NP11FL lens throw distance (m) =  $H \times 0.8$  : 0.6 m (min.) to 2.5 m (max.)

NP30ZL lens throw distance (m) =  $H \times 0.8$  to  $H \times 1.1$  : 1.0 m (min.) to 10.9 m (max.)

NP12ZL lens throw distance (m) =  $H \times 1.2$  to  $H \times 1.6$  : 0.7 m (min.) to 16.0 m (max.)

NP13ZL lens throw distance (m) =  $H \times 1.5$  to  $H \times 3.0$  : 1.2 m (min.) to 30.8 m (max.)

NP14ZL lens throw distance (m) =  $H \times 3.0$  to  $H \times 4.8$  : 3.6 m (min.) to 49.2 m (max.)

NP15ZL lens throw distance (m) =  $H \times 4.7$  to  $H \times 7.3$  : 5.7 m (min.) to 73.8 m (max.)

"H" (Horizontal) refers to the screen width.

\* Figures differ by several % with the table above because the calculation is approximate.

Ex.: Throw distance when projecting on a 150" screen with the XGA Type using the NP13ZL lens:

According to the "Screen Size (for reference)" table (→ page 256), H (screen width) = 304.8 cm.

The throw distance is  $304.8 \text{ cm} \times 1.5$  to  $304.8 \text{ cm} \times 3.0 = 457.2 \text{ cm}$  to  $914.4 \text{ cm}$  (because of the zoom lens).

Projection range for the different lenses

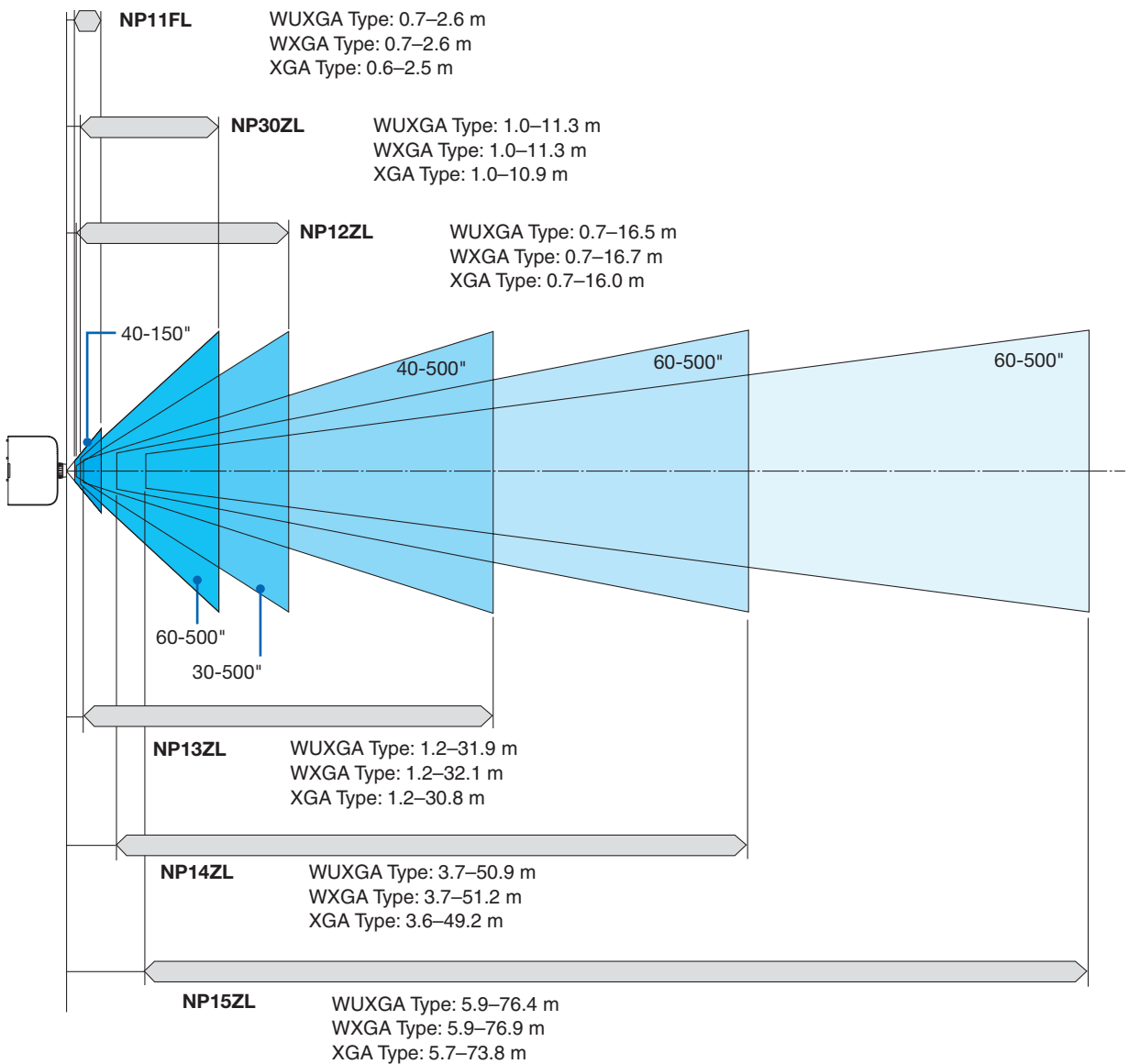

**Tables of screen sizes and dimensions**

**WUXGA Type/WXGA Type**

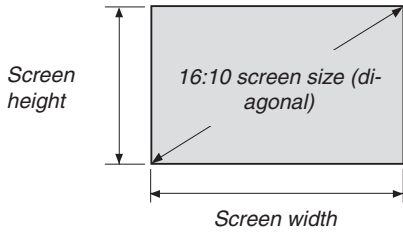

Size (inches)	Screen width		Screen height	
	(inches)	(cm)	(inches)	(cm)
30	25.4	64.6	15.9	40.4
40	33.9	86.2	21.2	53.8
60	50.9	129.2	31.8	80.8
80	67.8	172.3	42.4	107.7
100	84.8	215.4	53.0	134.6
120	101.8	258.5	63.6	161.5
150	127.2	323.1	79.5	201.9
200	169.6	430.8	106.0	269.2
240	203.5	516.9	127.2	323.1
300	254.4	646.2	159.0	403.9
400	339.2	861.6	212.0	538.5
500	424.0	1077.0	265.0	673.1

**XGA Type**

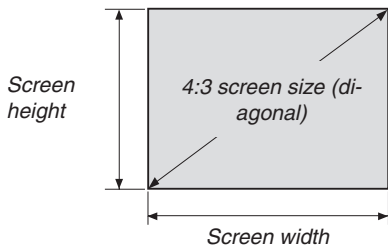

Size (inches)	Screen width		Screen height	
	(inches)	(cm)	(inches)	(cm)
30	24	61.0	18	45.7
40	32	81.3	24	61.0
60	48	121.9	36	91.4
80	64	162.6	48	121.9
100	80	203.2	60	152.4
120	96	243.8	72	182.9
150	120	304.8	90	228.6
200	160	406.4	120	304.8
240	192	487.7	144	365.8
300	240	609.6	180	457.2
400	320	812.8	240	609.6
500	400	1016.0	300	762.0

### Lens shifting range

This projector is equipped with a lens shift function for adjusting the position of the projected image by turning the lens shift dials. The lens can be shifted within the range shown below.

**NOTE:**

- The lens shift function cannot be used when using the NP11FL lens.
- Please do not use the lens shift function when projecting portrait images. Please use it with the lens in the center.

\* Refer to the lens shift table on the next page for the drawing number of the lens shift range.

### Desk/front projection

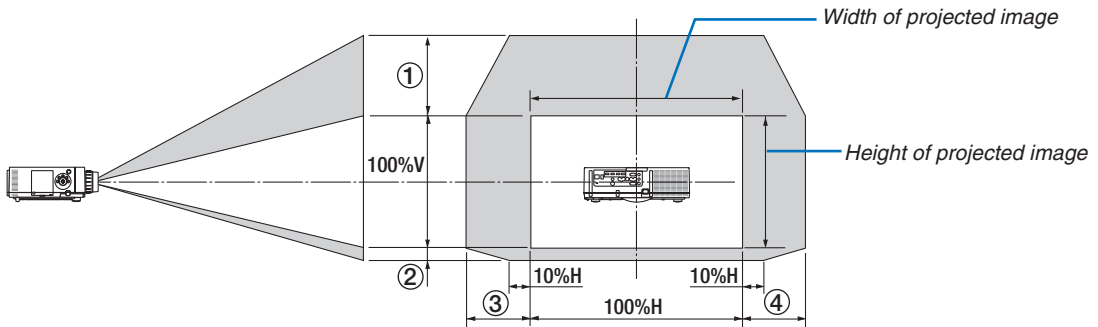

Description of symbols: V indicates vertical (height of the projected image), H indicates horizontal (width of the projected image).

### Ceiling/front projector

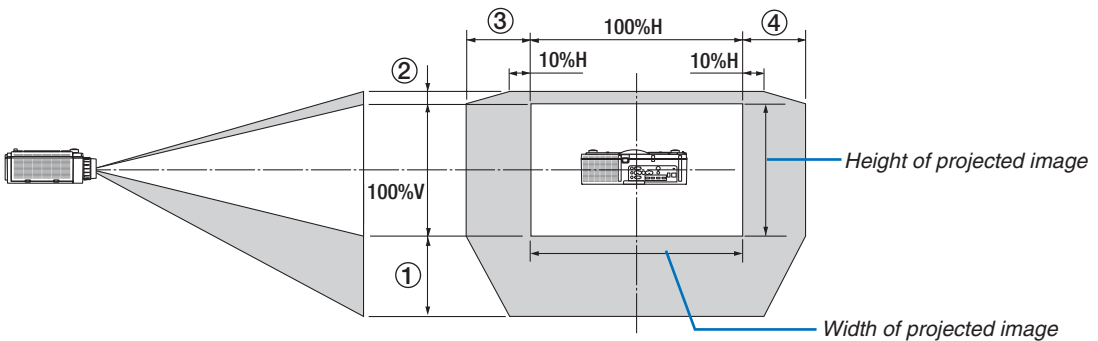

## Lens shift table

Applicable type	Drawing number	Lens unit				
		NP30ZL	NP12ZL	NP13ZL	NP14ZL	NP15ZL
WUXGA Type	①	50% V	50% V	50% V	50% V	50% V
	②	10% V	10% V	10% V	10% V	10% V
	③	20% H*	30% H	30% H	30% H	30% H
	④	20% H*	30% H	30% H	30% H	30% H
WXGA Type	①	50% V	60% V	60% V	60% V	60% V
	②	10% V	10% V	10% V	10% V	10% V
	③	20% H	30% H	30% H	30% H	30% H
	④	20% H	30% H	30% H	30% H	30% H
XGA Type	①	35% V	50% V	50% V	50% V	50% V
	②	10% V	10% V	10% V	10% V	10% V
	③	20% H	30% H	30% H	30% H	30% H
	④	20% H	30% H	30% H	30% H	30% H

\* For WUXGA Type, the shift range in the horizontal direction is up to 15% H when using the lens unit "NP13ZL" to project a screen exceeding Model 150.

Ex.: When projecting on a 150" screen

The explanation is for a XGA Type projector (4:3 panel) with a NP12ZL lens fitted.

- Please replace the screen dimensions and maximum shift value in the calculations for the WXGA Type and WUXGA Type projectors (16:10 panel) as well.

According to the tables of screen sizes and dimensions (→ page 256), H = 304.8 cm, V = 228.6 cm.

Adjustment range in the vertical direction: The projected image can be moved upwards  $0.5 \times 228.6 \text{ cm} = 114 \text{ cm}$ , downwards  $0.1 \times 228.6 \text{ cm} = 22 \text{ cm}$  (when the lens is at the center position). For a ceiling/front installation, the above figures are inverted.

Adjustment range in the horizontal direction: The projected image can be moved to the left  $0.3 \times 304.8 \text{ cm} = 91 \text{ cm}$ , to the right  $0.3 \times 304.8 \text{ cm} = 91 \text{ cm}$ .

\* Figures differ by several % because the calculation is approximate.



## ② Compatible Input Signal List

### Analog Computer Signal

Signal	Resolution ( dots )	Aspect Ratio	Refresh Rate ( Hz )
VGA	640 × 480	4 : 3	60/72/75/85/iMac
SVGA	800 × 600	4 : 3	56/60/72/75/85/iMac
XGA	1024 × 768 *1	4 : 3	60/70/75/85/iMac
XGA+	1152 × 864	4 : 3	60/70/75/85
WXGA	1280 × 768 *2	15 : 9	60
	1280 × 800 *2	16 : 10	60
	1360 × 768 *5	16 : 9 *4	60
	1366 × 768 *5	16 : 9 *4	60
Quad-VGA	1280 × 960	4 : 3	60/75/85
SXGA	1280 × 1024	5 : 4	60/75/85
SXGA+	1400 × 1050	4 : 3	60/75
WXGA+	1440 × 900	16 : 10	60
WXGA++	1600 × 900	16 : 9	60
UXGA	1600 × 1200 *3	4 : 3	60/65/70/75
WSXGA+	1680 × 1050	16 : 10	60
WUXGA	1920 × 1200 *3	16 : 10	60 (Reduced Blanking)
2K	2048 × 1080	17 : 9	60
Full HD	1920 × 1080 *3	16 : 9	60
MAC 13"	640 × 480	4 : 3	67
MAC 16"	832 × 624	4 : 3	75
MAC 19"	1024 × 768	4 : 3	75
MAC 21"	1152 × 870 *6	4 : 3 *4	75
MAC 23"	1280 × 1024	5 : 4	65

### Component

Signal	Resolution ( dots )	Aspect Ratio	Refresh Rate ( Hz )
HDTV (1080p)	1920 × 1080	16 : 9	50/60
HDTV (1080i)	1920 × 1080	16 : 9	48/50/60
HDTV (720p)	1280 × 720	16 : 9	50/60
SDTV (480p)	720 × 480	4:3 / 16:9	60
SDTV (576p)	720 × 576	4:3 / 16:9	50
SDTV (480i)	720 × 480	4:3 / 16:9	60
SDTV (576i)	720 × 576	4:3 / 16:9	50

### Composite Video/S-Video

Signal	Aspect Ratio	Refresh Rate ( Hz )
NTSC	4 : 3	60
PAL	4 : 3	50
PAL60	4 : 3	60
SECAM	4 : 3	50

## HDMI

Signal	Resolution ( dots )	Aspect Ratio	Refresh Rate ( Hz )
VGA	640 × 480	4 : 3	60
SVGA	800 × 600	4 : 3	60
XGA	1024 × 768 *1	4 : 3	60
HD	1280 × 720 *2	16 : 9	60
WXGA	1280 × 768 *2	15 : 9	60
	1280 × 800 *2	16 : 10	60
	1366 × 768 *5	16 : 9 *4	60
Quad-VGA	1280 × 960	4 : 3	60
SXGA	1280 × 1024	5 : 4	60
SXGA+	1400 × 1050	4 : 3	60
WXGA+	1440 × 900	16 : 10	60
WXGA++	1600 × 900	16 : 9	60
WSXGA+	1680 × 1050	16 : 10	60
UXGA	1600 × 1200 *3	4 : 3	60
Full HD	1920 × 1080 *3	16 : 9	60
WUXGA	1920 × 1200 *3	16 : 10	60
2K	2048 × 1080	17 : 9	60
WQHD iMac 27"	2560 × 1440	16 : 9	60
WQXGA	2560 × 1600	16 : 10	60 (Reduced Blanking)
4K	3840 × 2160	16 : 9	23.98/24/25/29.97/30
	4096 × 2160	17 : 9	24
HDTV(1080p)	1920 × 1080	16 : 9	24/25/30/50/60
HDTV(1080i)	1920 × 1080	16 : 9	48/50/60
HDTV (720p)	1280 × 720	16 : 9	50/60
SDTV (480i/p)	720/1440 × 480	4:3 / 16:9	60
SDTV (576i/p)	720/1440 × 576	4:3 / 16:9	50

## HDMI 3D

Signal Resolution ( dots )	Refresh Rate ( Hz )	Aspect Ratio	3D Format
1920 × 1080p	23.98/24	16 : 9	Frame Packing
			Side By Side
	Top and Bottom		
	Side By Side		
25	Top and Bottom		
	Side By Side		
50	Top and Bottom		
	Side By Side		
59.94/60	Top and Bottom		
	Side By Side		
1920 × 1080i	50	Top and Bottom	
		Side By Side	
	59.94/60	Top and Bottom	
		Side By Side	
1280 × 720p	50	Frame Packing	
		Side By Side	
	59.94/60	Top and Bottom	
		Frame Packing	
59.94/60	Side By Side		
	Top and Bottom		

## DisplayPort

Signal	Resolution ( dots )	Aspect Ratio	Refresh Rate ( Hz )
VGA	640 × 480	4 : 3	60
SVGA	800 × 600	4 : 3	60
XGA	1024 × 768 *1	4 : 3	60
HD	1280 × 720 *2	16 : 9	60
WXGA	1280 × 768 *2	15 : 9	60
	1280 × 800 *2	16 : 10	60
	1366 × 768 *5	16 : 9 *4	60
Quad-VGA	1280 × 960	4 : 3	60
SXGA	1280 × 1024	5 : 4	60
SXGA+	1400 × 1050	4 : 3	60
WXGA+	1440 × 900	16 : 10	60
WXGA++	1600 × 900	16 : 9	60
WSXGA+	1680 × 1050	16 : 10	60
UXGA	1600 × 1200 *3	4 : 3	60
Full HD	1920 × 1080 *3	16 : 9	60
WUXGA	1920 × 1200 *3	16 : 10	60 (Reduced Blanking)
2K	2048 × 1080	17 : 9	60
WQHD iMac 27"	2560 × 1440	16 : 9	60
WQXGA	2560 × 1600	16 : 10	60 (Reduced Blanking)
4K	3840 × 2160	16 : 9	23.98/24/25/29.97/30
	4096 × 2160	17 : 9	24
HDTV(1080p)	1920 × 1080	16 : 9	24/25/30/50/60
HDTV (720p)	1280 × 720	16 : 9	50/60
SDTV (480i/p)	720/1440 × 480	4:3 / 16:9	60
SDTV (576i/p)	720/1440 × 576	4:3 / 16:9	50

## DisplayPort 3D

Signal Resolution ( dots )	Refresh Rate ( Hz )	Aspect Ratio	3D Format
1920 × 1080p	23.98/24	16 : 9	Frame Packing
			Side By Side
	Top and Bottom		
	Side By Side		
25	Top and Bottom		
	Side By Side		
50	Top and Bottom		
	Side By Side		
59.94/60	Top and Bottom		
	Side By Side		
1920 × 1080i	50	Top and Bottom	
		Side By Side	
	59.94/60	Top and Bottom	
		Side By Side	
1280 × 720p	50	Frame Packing	
		Side By Side	
	59.94/60	Top and Bottom	
		Frame Packing	
	Side By Side		
	Top and Bottom		

\*1 Native resolution on XGA Type

\*2 Native resolution on WXGA Type

\*3 Native resolution on WUXGA Type

\*4 Approximate Value

\*5 The projector may fail to display these signals correctly when [AUTO] is selected for [ASPECT RATIO] in the on-screen menu. The factory default is [AUTO] for [ASPECT RATIO]. To display these signals, select [16:9] for [ASPECT RATIO].

\*6 The projector may fail to display these signals correctly when [AUTO] is selected for [ASPECT RATIO] in the on-screen menu. The factory default is [AUTO] for [ASPECT RATIO]. To display these signals, select [4:3] for [ASPECT RATIO].

- Signals exceeding the projector's resolution are handled with Advanced AccuBlend.
- With Advanced AccuBlend, the size of characters and ruled lines may be uneven and colors may be blurred.
- Upon shipment, the projector is set for signals with standard display resolutions and frequencies, but adjustments may be required depending on the type of computer.

### ③ Specifications

#### [HDBaseT Models]

Model name		6762WUA/6752WUA/6767WA/6757WA/6772A/6762A	
Method		Three primary color liquid crystal shutter projection method	
Specifications of main parts			
Liquid crystal panel	Size	6772A/6762A: 0.79" (with MLA) × 3 (aspect ratio: 4:3) 6767WA/6757WA: 0.76" (with MLA) × 3 (aspect ratio: 16:10) 6762WUA/6752WUA: 0.76" (with MLA) × 3 (aspect ratio: 16:10)	
	Pixels <sup>(*)</sup>	6772A/6762A: 786,432 (1024 dots × 768 lines) 6767WA/6757WA: 1,024,000 (1280 dots × 800 lines) 6762WUA/6752WUA: 2,304,000 (1920 dots × 1200 lines)	
Projection lenses	Zoom	Manual (zoom range depends on lens)	
	Focus	Manual	
	Lens shifting	Manual	
Light source		6772A/6767WA/6762WUA: 350 W AC lamp (264 W when Eco mode is on) 6762A/6757WA/6752WUA: 330 W AC lamp (264 W when Eco mode is on)	
Optical device		Optical isolation by dichroic mirror, combining by dichroic prism	
Light output <sup>(2)</sup> <sup>(3)</sup>	ECO OFF	6772A : 7200 lm, 6762A: 6200 lm, 6767WA: 6700 lm, 6757WA: 5700 lm, 6762WUA: 6200 lm, 6752WUA: 5200 lm	
Contrast ratio <sup>(2)</sup> (all white/all black)		6772A/6767WA/6762WUA: 6000:1 6762A/6757WA/6752WUA: 5000:1	
Screen size (throw distance)		30" to 500" (throw distance depends on lens)	
Color reproducibility		10-bit color processing (approx. 1.07 billion colors)	
Audio output		Built-in 10W monaural speaker	
Scanning frequency	Horizontal	Analog: 15 kHz, 24 to 100 kHz (24 kHz or greater for RGB inputs), conforming to VESA standards Digital: 15 kHz, 24 to 153 kHz, conforming to VESA standards	
	Vertical	Analog: 48 Hz, 50 to 85 Hz, 100, 120 Hz conforming to VESA standards Digital: 24, 25, 30, 48 Hz, 50 to 85 Hz, 100, 120 Hz conforming to VESA standards	
Main adjustment functions		Manual zoom, manual focus, manual lens shift, input signal switching (HDMI1/HDMI2/DisplayPort/BNC/BNC(CV)/BNC(Y/C)/COMPUTER/HDBaseT), auto image adjustment, picture enlarging, picture position adjustment, muting (both video and audio), power on/standby, on-screen display/selection, etc.	
Max. display resolution (horizontal × vertical)		Analog: 1920 × 1200 (handled with Advanced AccuBlend) Digital: 4096 × 2160 (handled with Advanced AccuBlend)	
Input signals			
R,G,B,H,V		RGB: 0.7Vp-p/75Ω Y: 1.0Vp-p/75Ω (with Negative Polarity Sync) Cb, Cr (Pb, Pr): 0.7Vp-p/75Ω H/V Sync: 4.0Vp-p/TTL Composite Sync: 4.0Vp-p/TTL Sync on G: 1.0Vp-p/75Ω (with Sync)	
Composite video		1.0Vp-p/75Ω	
S-Video		Y: 1.0Vp-p/75Ω C: 286Vp-p/75Ω	
Component		Y: 1.0Vp-p/75Ω (with Sync) Cb, Cr (Pb, Pr): 0.7Vp-p/75Ω DTV: 480i, 480p, 720p, 1080i, 1080p (60Hz) 576i, 576p, 720p, 1080i (50Hz) DVD: Progressive signal (50/60Hz)	
Audio		0.5Vrms/22kΩ or greater	
Input/output connectors			
Computer/Component	Video input	Mini D-Sub 15-pin × 1, BNC connector × 5	
	Audio input	Stereo mini jack × 2	
	Audio output	Stereo mini jack × 1 (common for all signals)	
HDMI	Video input	HDMI® Connector type A × 2 Deep Color (color depth): 8-/10-/12-bit compatible Colorimetry: RGB, YcbCr444 and YcbCr422 compatible LipSync compatible, HDCP compatible <sup>(4)</sup> , Supports 4K and 3D	
	Video output	Repeater	
	Audio input	HDMI: Sampling frequency – 32/44.1/48 kHz, Sampling bits – 16/20/24 bits	

Model name		6762WUA/6752WUA/6767WA/6757WA/6772A/6762A	
HDBaseT	Video input	Deep Color (color depth): Support 8/10/12 bits Colorimetry: Support RGB, YCbCr444 and YCbCr422 Support LipSync , HDCP <sup>(*)4</sup> , 4K , 3D	
		Audio input	Sampling frequency: 32/44.1/48 kHz Sampling bit: 16/20/24 bit
	DisplayPort	Video input	DisplayPort × 1 Data rate: 2.7Gbps/1.62Gbps No. lanes: 1 lane/2 lanes/4 lanes Color depth: 6-bit, 8-bit, 10-bit Colorimetry: RGB, YcbCr444 and YcbCr422 compatible HDCP compatible <sup>(*)4</sup>
		Audio input	DisplayPort: Sampling frequency – 32/44.1/48 kHz, Sampling bits – 16/20/24 bits
	BNC (CV)	Video input	BNC × 1
		Audio input	(shared with the BNC, BNC (CV), BNC (Y/C) audio input terminals)
	BNC (Y/C)	Video input	BNC × 2
		Audio input	(shared with the BNC, BNC (CV), BNC (Y/C) audio input terminals)
	PC control connector		D-Sub 9-pin × 1
	USB port		USB type A × 1
Ethernet/HDBaseT port		RJ-45 × 1, Supports BASE-TX	
Remote connector		Stereo mini jack × 1	
3D SYNC output terminal		5 V / 10 mA, synchronized signal output for 3D use	
Usage environment		Operating temperature: 41 to 104°F (5 to 40°C) <sup>(*)5</sup> Operating humidity: 20 to 80% (with no condensation) Storage temperature: 14 to 122°F (-10 to 50°C) Storage humidity: 20 to 80% (with no condensation) Operating altitude: 0 to 3650 m/12000 feet (1700 to 3650 m/5500 to 12000 feet: Set [FAN MODE] to [HIGH ALUTITUDE])	
Power supply		100-240 V AC, 50/60Hz	
Power consumption	Eco mode off	6772A/6767WA/6762WUA: 483 W (100-130 V)/460W (200-240 V) 6762A/6757WA/6752WUA: 463 W (100-130 V)/440W (200-240 V)	
	Eco mode on	6772A/6767WA/6762WUA/6762A/6757WA/6752WUA: 377 W (100-130 V)/362 W (200-240 V)	
	STANDBY (NORAML)	0.11 W (100-130 V)/0.16 W(200-240 V)	
	STANDBY (HDBaseT STANDBY)	7.4 W(100-130 V)/7.9 W(200-240 V)	
Rated input current		6772A/6767WA/6762WUA: 5.5 A-2.2 A 6762A/6757WA/6752WUA: 5.1 A-2.2 A	
External dimensions		19.7" (width) × 5.68" (height) × 14.1" (depth)/499 (width) × 142 (height) × 359 (depth) mm (not including protruding parts) 19.7" (width) × 6.38" (height) × 14.5" (depth)/499 (width) × 162 (height) × 368 (depth) mm (including protruding parts)	
Weight		18.5 lbs/8.4 kg (not including lens)	

\*1 Effective pixels are more than 99.99%.

\*2 This is the light output value (lumens) when the [PRESET] mode is set to [HIGH-BRIGHT]. The light output values will drop to 80% when [ON] is selected for [ECO MODE]. If any other mode is selected as the [PRESET] mode, the light output value may drop slightly.

\*3 Compliance with ISO21118-2005

\*4 HDMI® (Deep Color, Lip Sync) with HDCP  
What is HDCP/HDCP technology?

HDCP is an acronym for High-bandwidth Digital Content Protection. High bandwidth Digital Content Protection (HDCP) is a system for preventing illegal copying of video data sent over a High-Definition Multimedia Interface (HDMI).

If you are unable to view material via the HDMI input, this does not necessarily mean the projector is not functioning properly. With the implementation of HDCP, there may be cases in which certain content is protected with HDCP and might not be displayed due to the decision/intention of the HDCP community (Digital Content Protection, LLC).

Video: Deep Color; 8/10/12-bit, LipSync

Audio: LPCM; up to 2 ch, sample rate 32/44.1/48 KHz, sample bit; 16/20/24-bit

\*5 95 to 104°F (35 to 40°C) – “Forced eco mode”

(6762WUA/6752WUA will shift to the eco-mode in stages starting from 33 °C.)

- These specifications and the product's design are subject to change without notice.

**[MM Models]**

Model name		6762WU/6752WU/6767W/6757W/6772/6762
Method		Three primary color liquid crystal shutter projection method
Specifications of main parts		
Liquid crystal panel	Size	6772/6762: 0.79" (with MLA) × 3 (aspect ratio: 4:3) 6767W/6757W: 0.76" (with MLA) × 3 (aspect ratio: 16:10) 6762WU/6752WU: 0.76" (with MLA) × 3 (aspect ratio: 16:10)
	Pixels <sup>(*)</sup>	6772/6762: 786,432 (1024 dots × 768 lines) 6767W/6757W: 1,024,000 (1280 dots × 800 lines) 6762WU/6752WU: 2,304,000 (1920 dots × 1200 lines)
Projection lenses	Zoom	Manual (zoom range depends on lens)
	Focus	Manual
	Lens shifting	Manual
Light source		6772/6767W/6762WU: 350 W AC lamp (264 W when Eco mode is on) 6762/6757W/6752WU: 330 W AC lamp (264 W when Eco mode is on)
Optical device		Optical isolation by dichroic mirror, combining by dichroic prism
Light output <sup>(*)</sup> <sup>(*)</sup>	ECO OFF	6772 : 7200 lm, 6762: 6200 lm, 6767W: 6700 lm, 6757W: 5700 lm, 6762WU: 6200 lm, 6752WU: 5200 lm
Contrast ratio <sup>(*)</sup> (all white/all black)		6772/6767W/6762WU: 6000:1 6762/6757W/6752WU: 5000:1
Screen size (throw distance)		30" to 500" (throw distance depends on lens)
Color reproducibility		10-bit color processing (approx. 1.07 billion colors) <sup>(*)</sup>
Audio output		Built-in 10W monaural speaker
Scanning frequency	Horizontal	Analog: 15 kHz, 24 to 100 kHz (24 kHz or greater for RGB inputs), conforming to VESA standards Digital: 15 kHz, 24 to 153 kHz, conforming to VESA standards
	Vertical	Analog: 48 Hz, 50 to 85 Hz, 100, 120 Hz conforming to VESA standards Digital: 24, 25, 30, 48 Hz, 50 to 85 Hz, 100, 120 Hz conforming to VESA standards
Main adjustment functions		Manual zoom, manual focus, manual lens shift, input signal switching (HDMI1/HDMI2/DisplayPort/BNC/BNC(CV)/BNC(Y/C)/COMPUTER/ETHERNET), auto image adjustment, picture enlarging, picture position adjustment, muting (both video and audio), power on/standby, on-screen display/selection, etc.
Max. display resolution (horizontal × vertical)		Analog: 1920 × 1200 (handled with Advanced AccuBlend) Digital: 4096 × 2160 (handled with Advanced AccuBlend)
Input signals		
R,G,B,H,V		RGB: 0.7Vp-p/75Ω Y: 1.0Vp-p/75Ω (with Negative Polarity Sync) Cb, Cr (Pb, Pr): 0.7Vp-p/75Ω H/V Sync: 4.0Vp-p/TTL Composite Sync: 4.0Vp-p/TTL Sync on G: 1.0Vp-p/75Ω (with Sync)
	Composite video	1.0Vp-p/75Ω
	S-Video	Y: 1.0Vp-p/75Ω
		C: 286Vp-p/75Ω
	Component	Y: 1.0Vp-p/75Ω (with Sync)
		Cb, Cr (Pb, Pr): 0.7Vp-p/75Ω
		DTV: 480i, 480p, 720p, 1080i, 1080p (60Hz) 576i, 576p, 720p, 1080i (50Hz)
DVD: Progressive signal (50/60Hz)		
Audio	0.5Vrms/22kΩ or greater	
Input/output connectors		
Computer/Component	Video input	Mini D-Sub 15-pin × 1, BNC connector × 5
	Audio input	Stereo mini jack × 2
	Audio output	Stereo mini jack × 1 (common for all signals)
HDMI	Video input	HDMI® Connector type A × 2 Deep Color (color depth): 8-/10-/12-bit compatible Colorimetry: RGB, YcbCr444 and YcbCr422 compatible LipSync compatible, HDCP compatible <sup>(*)</sup> , Supports 4K and 3D
		Video output
	Audio input	HDMI: Sampling frequency – 32/44.1/48 kHz, Sampling bits – 16/20/24 bits

Model name		6762WU/6752WU/6767W/6757W/6772/6762		
	DisplayPort	Video input	DisplayPort × 1 Data rate: 2.7Gbps/1.62Gbps No. lanes: 1 lane/2 lanes/4 lanes Color depth: 6-bit, 8-bit, 10-bit Colorimetry: RGB, YcbCr444 and YcbCr422 compatible HDCP compatible <sup>(5)</sup>	
		Audio input	DisplayPort: Sampling frequency – 32/44.1/48 kHz, Sampling bits – 16/20/24 bits	
	BNC (CV)	Video input	BNC × 1	
		Audio input	(shared with the BNC, BNC (CV), BNC (Y/C) audio input terminals)	
	BNC (Y/C)	Video input	BNC × 2	
		Audio input	(shared with the BNC, BNC (CV), BNC (Y/C) audio input terminals)	
	PC control connector		D-Sub 9-pin × 1	
	USB port		USB type A × 1	
	USB port for wireless LAN		USB type A × 1	
	Ethernet port		RJ-45 × 1, 10/100 BASE	
Remote connector		Stereo mini jack × 1		
3D SYNC output terminal		5 V / 10 mA, synchronized signal output for 3D use		
Usage environment		Operating temperature: 41 to 104°F (5 to 40°C) <sup>(6)</sup> Operating humidity: 20 to 80% (with no condensation) Storage temperature: 14 to 122°F (-10 to 50°C) Storage humidity: 20 to 80% (with no condensation) Operating altitude: 0 to 3650 m/12000 feet (1700 to 3650 m/5500 to 12000 feet: Set [FAN MODE] to [HIGH ALUTITUDE])		
Power supply		100-240 V AC, 50/60Hz		
Power consumption	Eco mode off	6772/6767W/6762WU: 483 W (100-130 V)/460W (200-240 V) 6762/6757W/6752WU: 463 W (100-130 V)/440W (200-240 V)		
	Eco mode on	6772/6767W/6762WU/6762/6757W/6752WU: 377 W (100-130 V)/362 W (200-240 V)		
	STANDBY (NORAML)	0.11 W (100-130 V)/0.16 W (200-240 V)		
	STANDBY (NETWORK STANDBY)	4.7 W (100-130 V)/4.9 W (200-240 V)		
Rated input current		6772/6767W/6762WU: 5.5 A-2.2 A 6762/6757W/6752WU: 5.1 A-2.2 A		
External dimensions		19.7" (width) × 5.68" (height) × 14.1" (depth)/499 (width) × 142 (height) × 359 (depth) mm (not including protruding parts) 19.7" (width) × 6.38" (height) × 14.5" (depth)/499 (width) × 162 (height) × 368 (depth) mm (including protruding parts)		
Weight		18.5 lbs/8.4 kg (not including lens)		

\*1 Effective pixels are more than 99.99%.

\*2 This is the light output value (lumens) when the [PRESET] mode is set to [HIGH-BRIGHT]. The light output values will drop to 80% when [ON] is selected for [ECO MODE]. If any other mode is selected as the [PRESET] mode, the light output value may drop slightly.

\*3 Compliance with ISO21118-2005

\*4 Full color (approx. 16.77 million colors or greater) when the Ethernet input connector is selected.

\*5 HDMI® (Deep Color, Lip Sync) with HDCP

What is HDCP/HDCP technology?

HDCP is an acronym for High-bandwidth Digital Content Protection. High bandwidth Digital Content Protection (HDCP) is a system for preventing illegal copying of video data sent over a High-Definition Multimedia Interface (HDMI).

If you are unable to view material via the HDMI input, this does not necessarily mean the projector is not functioning properly. With the implementation of HDCP, there may be cases in which certain content is protected with HDCP and might not be displayed due to the decision/intention of the HDCP community (Digital Content Protection, LLC).

Video: Deep Color; 8/10/12-bit, LipSync

Audio: LPCM; up to 2 ch, sample rate 32/44.1/48 KHz, sample bit; 16/20/24-bit

\*6 95 to 104°F (35 to 40°C) – "Forced eco mode"

(6762WU/6752WU will shift to the eco-mode in stages starting from 33 °C.)

• These specifications and the product's design are subject to change without notice.

## 4 Cabinet Dimensions

Unit: mm (inch)

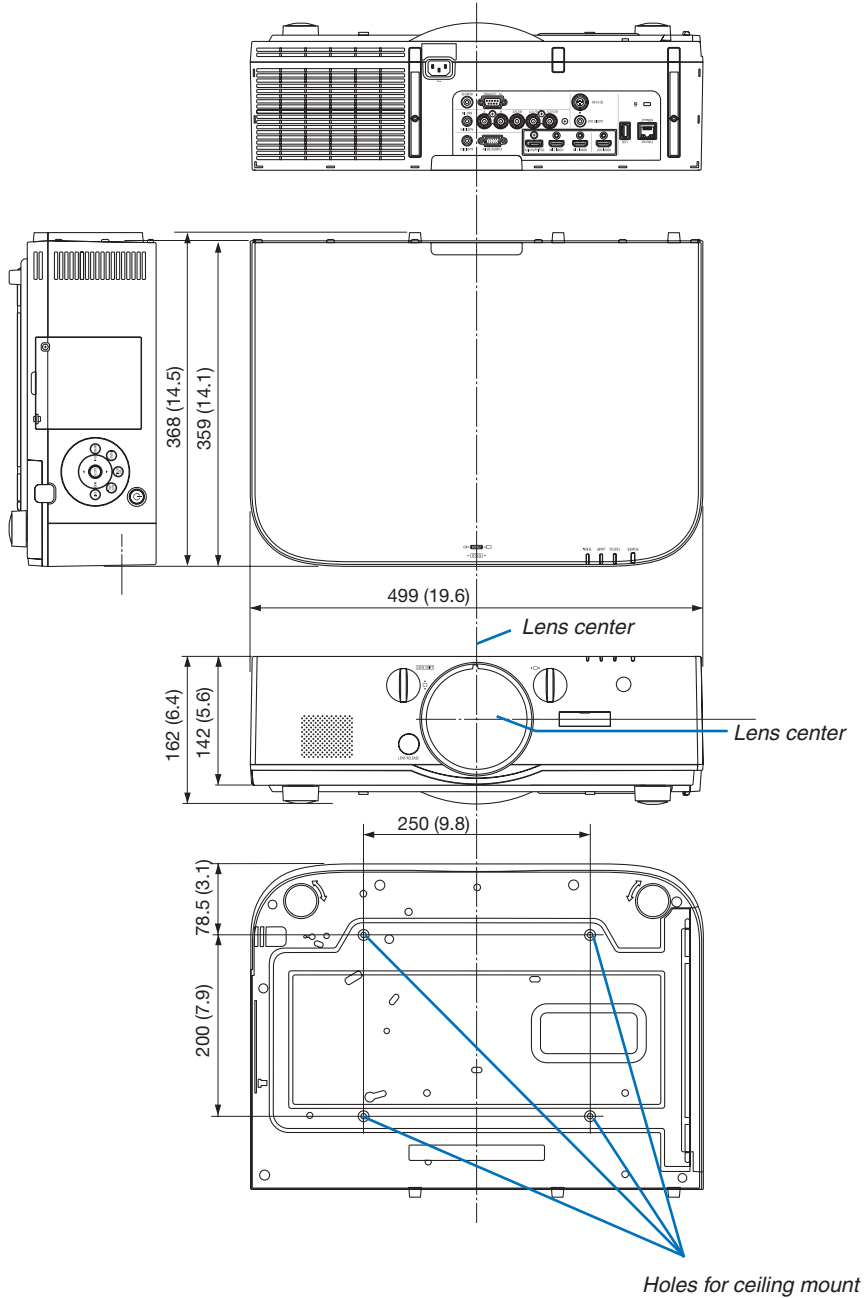



## 5 Mounting the cable cover (sold separately)

Mounting the separately sold cable cover (NP04CV) on the projector allows you hide the cables for a cleaner appearance.

### CAUTION

- After mounting the cable cover, be sure to fasten using the screws provided. If not, the cable cover could fall, damaging the cable cover and possibly resulting in injury.
- Do not bundle the power cord and place it under the cable cover. Doing so could lead to fire.
- Do not apply excessive force to the cable cover. Doing so could damage the cable cover, resulting in the projector falling or causing injury.

### Mounting

Preparations:

1. Connect the power cord and cables to the projector (the connection cords are omitted from the diagrams).
2. Prepare a Phillips screwdriver.

1. Insert the two round protrusions on the left and right edges of the cable cover into the grooves in the bottom of the projector to line it up.

*NOTE: Be careful not to let the power cord and cables get pinched by the cable cover.*

2. Turn the cable cover screw clockwise.

- Tighten the screw securely.

### Removing

1. Turn the cable cover screw counterclockwise until it turns loosely.

- Hold the cable cover while doing this to prevent it from falling.
- The screw does not come completely off.

2. Remove the cable cover.

- Turn the cable cover a little, then lift it off.

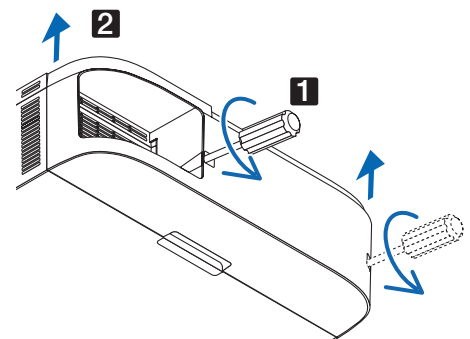
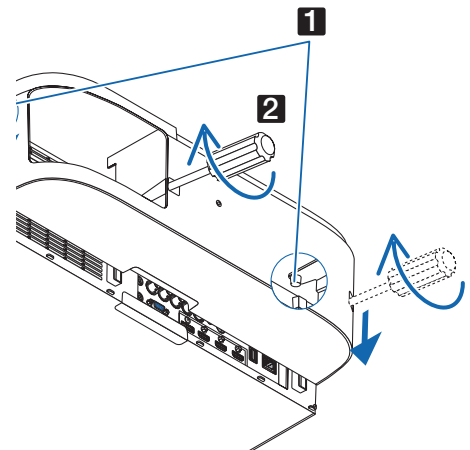

## ⑥ Pin assignments and signal names of main connectors

### COMPUTER IN/ Component Input Connector (Mini D-Sub 15 Pin)

Connection and signal level of each pin

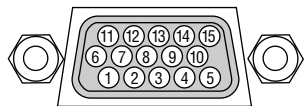

#### Signal Level

Video signal : 0.7Vp-p (Analog)

Sync signal : TTL level

Pin No.	RGB Signal (Analog)	YCbCr Signal
1	Red	Cr
2	Green or Sync on Green	Y
3	Blue	Cb
4	Ground	
5	Ground	
6	Red Ground	Cr Ground
7	Green Ground	Y Ground
8	Blue Ground	Cb Ground
9	No Connection	
10	Sync Signal Ground	
11	No Connection	
12	Bi-directional DATA (SDA)	
13	Horizontal Sync or Composite Sync	
14	Vertical Sync	
15	Data Clock	

### HDMI 1 IN/HDMI 2 IN Connector (Type A)

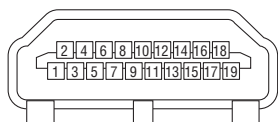

Pin No.	Signal	Pin No.	Signal
1	TMDS Data 2+	11	TMDS Clock Shield
2	TMDS Data 2 Shield	12	TMDS Clock-
3	TMDS Data 2-	13	CEC
4	TMDS Data 1+	14	Disconnection
5	TMDS Data 1 Shield	15	SCL
6	TMDS Data 1-	16	SDA
7	TMDS Data 0+	17	DDC/CEC grounding
8	TMDS Data 0 Shield	18	+5 V power supply
9	TMDS Data 0-	19	Hot plug detection
10	TMDS Clock +		

### DisplayPort IN Connector

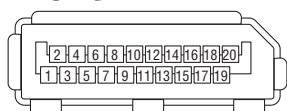

Pin No.	Signal	Pin No.	Signal
1	Main link lane 3-	11	Grounding 0
2	Grounding 3	12	Main link lane 0+
3	Main link lane 3+	13	Configuration 1
4	Main link lane 2-	14	Configuration 2
5	Grounding 2	15	Supplementary channel +
6	Main link lane 2+	16	Grounding 4
7	Main link lane 1-	17	Supplementary channel -
8	Grounding 1	18	Hot plug detection
9	Main link lane 1+	19	Return
10	Main link lane 0-	20	+3.3 V power supply

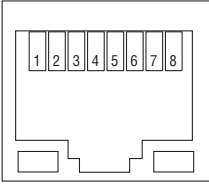
**Ethernet/HDBaseT Port (RJ-45)**

Pin No.	Signal
1	TxD+/HDBT0+
2	TxD-/HDBT0-
3	RxD+/HDBT1+
4	Disconnection/HDBT2+
5	Disconnection/HDBT2-
6	RxD-/HDBT1-
7	Disconnection/HDBT3+
8	Disconnection/HDBT3-

\* HDBaseT port is not supported on MM models.

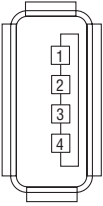
**USB-A Port (Type A)**

Pin No.	Signal
1	V <sub>BUS</sub>
2	D-
3	D+
4	Grounding

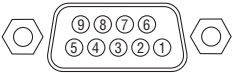
**PC CONTROL Port (D-Sub 9 Pin)****Communications protocol**

Pin No.	Signal
1	Unused
2	RxD reception data
3	TxD transmission data
4	Unused
5	Grounding
6	Unused
7	RTS transmission request
8	CTS transmission allowed
9	Unused

## 7 Troubleshooting

This section helps you resolve problems you may encounter while setting up or using the projector.

### Indicator Messages

#### Power Indicator

Indicator display		Projector status	Procedure
Off		Power is off.	–
Flashing	Blue (short flashes)	Preparing to turn power on	Wait a while.
	Blue (long flashes)	Off timer (enabled) Program timer (off time enabled)	–
	Orange (short flashes)	Projector cooling	Wait a while.
	Orange (long flashes)	Program timer (on time enabled)	
Lit	Blue	Power on	–
	Red	Standby mode (NORMAL)	–
	Orange	Standby mode (HDBaseT STANDBY)*1	–

\*1 Set to [NETWORK STANDBY] for MM models.

#### Status Indicator

Indicator display		Projector status	Procedure
Off		No problem, or standby mode	–
Flashing	Red (cycles of 1)	Cover problem	The lamp cover is not properly mounted. Mount it properly. (→ Page 180)
	Red (cycles of 4)	Fan problem	The cooling fan has stopped turning. Contact an NEC projector customer support center for repairs.
Flashing	Orange	Network conflict	It is not possible to connect the projector's built-in LAN and wireless LAN simultaneously to the same network. To connect the projector's built-in LAN and wireless LAN simultaneously, connect them to different networks.
Lit	Green	STANDBY MODE in sleep mode*2	–
	Orange	Button has been pressed while projector is in key lock mode	The projector's keys are locked. The setting must be canceled to operate the projector. (→ Page 119)
		Projector's ID number and remote control's ID number do not match	Check the control IDs. (→ Pages 120)

\*2 Sleep mode refers to the state whereby the functional restrictions due to the standby mode setting are removed.

**Lamp Indicator**

Indicator display		Projector status	Procedure
Off		The lamp is turned off.	–
Flash- ing	Green	Preparing to relight lamp after lighting has failed	Wait a while.
	Red	Lamp replacement grace period	The lamp has reached the end of its service life and is now in the replacement grace period (100 hours). Replace the lamp as soon as possible. (→ page 178)
	Red (cycles of 6)	Lamp does not light	The lamp has not turned on. Wait at least 1 minute, then turn the power back on. If the lamp still does not light, contact an Dukane Service Department.
Lit	Red	Lamp usage time exceeded	The lamp has exceeded its usage time. The projector's power cannot be turned on until the lamp is replaced. (→ page 178)
	Green	Lamp lit	–

**Temp. Indicator**

Indicator display		Projector status	Procedure
Off		No problem	
Flash- ing	Red (cycles of 2)	Temperature problem	The temperature protector has been activated. If the room temperature is high, move the projector to a cool place. If the problem still persists, contact Dukane Service Department.
Lit	Orange	High surrounding temperature	The surrounding temperature is high. Lower the room temperature.

**If the temperature protector is activated**

If the projector's internal temperature rises abnormally, the lamp turns off and the temperature indicator flashes (repeatedly in cycles of 2).

It may happen that the projector's temperature protector is simultaneously activated and the projector's power turns off.

If this happens, do the following:

- Unplug the power cord from the power outlet.
- If using in a place where the surrounding temperature is high, move the projector to a different, cool place.
- If there is dust in the ventilation holes, clean. (→ pages 174 and 177)
- Wait as such about 1 hour for the projector's internal temperature to lower.

## Common Problems & Solutions

(→ “Power/Status/Lamp Indicator” on page 270.)

Problem	Check These Items
Does not turn on or shut down	<ul style="list-style-type: none"> <li>• Check that the power cord is plugged in and that the power button on the projector cabinet or the remote control is on. (→ pages 15, 16)</li> <li>• Ensure that the lamp cover is installed correctly. (→ page 180)</li> <li>• Check to see if the projector has overheated. If there is insufficient ventilation around the projector or if the room where you are presenting is particularly warm, move the projector to a cooler location.</li> <li>• Check to see if you continue to use the projector for another 100 hours after the lamp has reached the end of its life. If so, replace the lamp. After replacing the lamp, reset the lamp hours used. (→ page 131)</li> <li>• The lamp may fail to light. Wait a full minute and then turn on the power again.</li> <li>• Set [FAN MODE] to [HIGH ALTITUDE] when using the projector at altitudes approximately 5500 feet/1700 meters or higher. Using the projector at altitudes approximately 5500 feet/1700 meters or higher without setting to [HIGH ALTITUDE] can cause the projector to overheat and the projector could shut down. If this happens, wait a couple minutes and turn on the projector. (→ page 112)</li> </ul> <p>If you turn on the projector immediately after the lamp is turned off, the fans run without displaying an image for some time and then the projector will display the image. Wait for a moment.</p>
Will turn off	<ul style="list-style-type: none"> <li>• Ensure that the [OFF TIMER], [AUTO POWER OFF] or [PROGRAM TIMER] is off. (→ page 115, 130)</li> </ul>
No picture	<ul style="list-style-type: none"> <li>• Check if the appropriate input is selected. (→ page 18) If there is still no picture, press the INPUT button or one of the input buttons again.</li> <li>• Ensure your cables are connected properly.</li> <li>• Use menus to adjust the brightness and contrast. (→ page 91)</li> <li>• Ensure that the lens cover is open. (→ page 16)</li> <li>• Reset the settings or adjustments to factory preset levels using the [RESET] in the Menu. (→ page 131)</li> <li>• Enter your registered keyword if the Security function is enabled. (→ page 38)</li> <li>• If the HDMI input or the DisplayPort signal cannot be displayed, try the following. <ul style="list-style-type: none"> <li>- Reinstall your driver for the graphics card built in your computer, or use the updated driver. <p>For reinstalling or updating your driver, refer to the user guide accompanied with your computer or graphics card, or contact the support center for your computer manufacturer.</p> <p>Install the updated driver or OS on your own responsibility.</p> <p>We are not liable for any trouble and failure caused by this installation.</p> </li> </ul> </li> <li>• For HDBaseT models, the signal may not be supported depending on the HDBaseT transmission device. In addition, RS232C interface may not be supported.</li> <li>• Both the composite video signal from each input connector as the computer, BNC, and BNC (CV), and the S-video signal from the BNC (Y/C) Input connector are not output from HDMI OUT Connector of this projector.</li> <li>• Be sure to connect the projector and notebook PC while the projector is in standby mode and before turning on the power to the notebook PC. <p>In most cases the output signal from the notebook PC is not turned on unless connected to the projector before being powered up.</p> <p>* If the screen goes blank while using your remote control, it may be the result of the computer's screen-saver or power management software.</p> </li> <li>• See also the page 274.</li> </ul>
Picture suddenly becomes dark	<ul style="list-style-type: none"> <li>• Check if the projector is in the Forced ECO mode because of too high ambient temperature. If this is the case, lower the internal temperature of the projector by selecting [HIGH] for [FAN MODE]. (→ page 112)</li> </ul>
Color tone or hue is unusual	<ul style="list-style-type: none"> <li>• Check if an appropriate color is selected in [WALL COLOR]. If so, select an appropriate option. (→ page 112)</li> <li>• Adjust [HUE] in [PICTURE]. (→ page 92)</li> </ul>
Image isn't square to the screen	<ul style="list-style-type: none"> <li>• Reposition the projector to improve its angle to the screen. (→ page 20)</li> <li>• Perform [GEOMETRIC CORRECTION] when the trapezoid is distorted. (→ page 102)</li> </ul>
Picture is blurred	<ul style="list-style-type: none"> <li>• Adjust the focus. (→ page 22)</li> <li>• Reposition the projector to improve its angle to the screen. (→ page 20)</li> <li>• Ensure that the distance between the projector and screen is within the adjustment range of the lens. (→ page 253)</li> <li>• Has the lens been shifted by an amount exceeding the guaranteed range? (→ page 257)</li> <li>• Condensation may form on the lens if the projector is cold, brought into a warm place and is then turned on. Should this happen, let the projector stand until there is no condensation on the lens.</li> </ul>
Flicker appears on screen	<ul style="list-style-type: none"> <li>• Set [FAN MODE] to other than [HIGH ALTITUDE] mode when using the projector at altitudes approximately 5500 feet/1700 meters or lower. Using the projector at altitudes less than approximately 5500 feet/1700 meters and setting to [HIGH ALTITUDE] can cause the lamp to overcool, causing the image to flicker. Switch [FAN MODE] to [AUTO]. (→ page 112)</li> </ul>
Image is scrolling vertically, horizontally or both	<ul style="list-style-type: none"> <li>• Check the computer's resolution and frequency. Make sure that the resolution you are trying to display is supported by the projector. (→ page 259)</li> <li>• Adjust the computer image manually with the Horizontal/Vertical in the [IMAGE OPTIONS]. (→ page 94)</li> </ul>

Problem	Check These Items
Remote control does not work	<ul style="list-style-type: none"><li>• Install new batteries. (→ page 12)</li><li>• Make sure there are no obstacles between you and the projector.</li><li>• Stand within 40 m/1575 inch of the projector. (→ page 13)</li><li>• To perform computer mouse operations using the projector's remote control, connect the optional mouse receiver to the computer. (→ page 33)</li></ul>
Indicator is lit or blinking	<ul style="list-style-type: none"><li>• See the POWER/STATUS/LAMP Indicator. (→ page 270)</li></ul>
Cross color in RGB mode	<ul style="list-style-type: none"><li>• Press the AUTO ADJ. button on the projector cabinet or the remote control. (→ page 26)</li><li>• Adjust the computer image manually with [CLOCK]/[PHASE] in [IMAGE OPTIONS] in the menu. (→ page 93)</li></ul>

For more information contact your dealer.

## If there is no picture, or the picture is not displayed correctly.

- Power on process for the projector and the PC.

Be sure to connect the projector and notebook PC while the projector is in standby mode and before turning on the power to the notebook PC.

In most cases the output signal from the notebook PC is not turned on unless connected to the projector before being powered up.

---

*NOTE: You can check the horizontal frequency of the current signal in the projector's menu under Information. If it reads "0kHz", this means there is no signal being output from the computer. (→ page 134 or go to next step)*

---

- Enabling the computer's external display.

Displaying an image on the notebook PC's screen does not necessarily mean it outputs a signal to the projector. When using a PC compatible laptop, a combination of function keys will enable/disable the external display. Usually, the combination of the "Fn" key along with one of the 12 function keys gets the external display to come on or off. For example, NEC laptops use Fn + F3, while Dell laptops use Fn + F8 key combinations to toggle through external display selections.

- Non-standard signal output from the computer

If the output signal from a notebook PC is not an industry standard, the projected image may not be displayed correctly. Should this happen, deactivate the notebook PC's LCD screen when the projector display is in use. Each notebook PC has a different way of deactivate/reactivate the local LCD screens as described in the previous step. Refer to your computer's documentation for detailed information.

- Image displayed is incorrect when using a Mac

When using a Mac with the projector, set the DIPswitch of the Mac adapter (not supplied with the projector) according to your resolution. After setting, restart your Mac for the changes to take affect.

For setting display modes other than those supported by your Mac and the projector, changing the DIP switch on a Mac adapter may bounce an image slightly or may display nothing. Should this happen, set the DIP switch to the 13" fixed mode and then restart your Mac. After that, restore the DIP switches to a displayable mode and then restart the Mac again.

---

*NOTE: A Video Adapter cable manufactured by Apple Computer is needed for a MacBook which does not have a mini D-Sub 15-pin connector.*

---

- Mirroring on a MacBook

\* When using the projector with a MacBook, output may not be set to 1024 × 768 unless "mirroring" is off on your MacBook. Refer to owner's manual supplied with your Mac computer for mirroring.

- Folders or icons are hidden on the Mac screen

Folders or icons may not be seen on the screen. Should this happen, select [View] → [Arrange] from the Apple menu and arrange icons.



## 8 PC Control Codes and Cable Connection

### PC Control Codes

Function	Code Data								
POWER ON	02H	00H	00H	00H	00H	02H			
POWER OFF	02H	01H	00H	00H	00H	03H			
INPUT SELECT HDMI1	02H	03H	00H	00H	02H	01H	A1H	A9H	
INPUT SELECT HDMI2	02H	03H	00H	00H	02H	01H	A2H	AAH	
INPUT SELECT DisplayPort	02H	03H	00H	00H	02H	01H	A6H	AEH	
INPUT SELECT BNC	02H	03H	00H	00H	02H	01H	02H	0AH	
INPUT SELECT BNC(CV)	02H	03H	00H	00H	02H	01H	06H	0EH	
INPUT SELECT BNC(Y/C)	02H	03H	00H	00H	02H	01H	0BH	13H	
INPUT SELECT COMPUTER	02H	03H	00H	00H	02H	01H	01H	09H	
INPUT SELECT HDBaseT	02H	03H	00H	00H	02H	01H	20H	28H	
PICTURE MUTE ON	02H	10H	00H	00H	00H	12H			
PICTURE MUTE OFF	02H	11H	00H	00H	00H	13H			
SOUND MUTE ON	02H	12H	00H	00H	00H	14H			
SOUND MUTE OFF	02H	13H	00H	00H	00H	15H			

*NOTE: Contact your local dealer for a full list of the PC Control Codes if needed.*

### Cable Connection

#### Communication Protocol

Baud rate .....38400 bps  
 Data length .....8 bits  
 Parity .....No parity  
 Stop bit .....One bit  
 X on/off .....None  
 Communications procedure .....Full duplex

*NOTE: Depending on the equipment, a lower baud rate may be recommended for long cable runs.*

### PC Control Connector (D-SUB 9P)

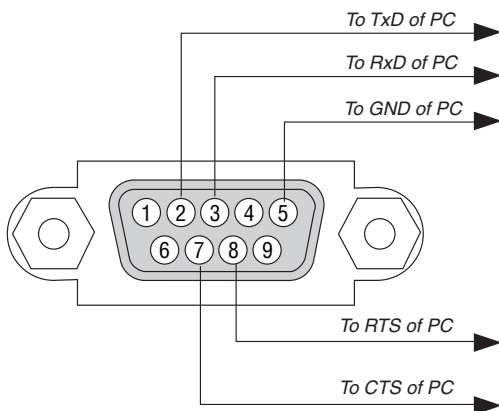

*NOTE 1: Pins 1, 4, 6 and 9 are no used.*

*NOTE 2: Jumper "Request to Send" and "Clear to Send" together on both ends of the cable to simplify cable connection.*

*NOTE 3: For long cable runs it is recommended to set communication speed within projector menus to 9600 bps.*

## 9 Troubleshooting Check List

Before contacting your dealer or service personnel, check the following list to be sure repairs are needed also by referring to the “Troubleshooting” section in your user’s manual. This checklist below will help us solve your problem more efficiently.

\* Print this page and the next page for your check.

**Frequency of occurrence**  always  sometimes (How often? \_\_\_\_\_)  other (\_\_\_\_\_)

### Power

- No power (POWER indicator does not light blue). See also “Status Indicator (STATUS)”.
- Power cord’s plug is fully inserted into the wall outlet.
- Lamp cover is installed correctly.
- Lamp Hours Used (lamp operation hours) was cleared after lamp replacement.
- No power even though you press and hold the POWER button.
- Shut down during operation.
  - Power cord’s plug is fully inserted into the wall outlet.
  - Lamp cover is installed correctly.
  - [AUTO POWER OFF] is turned off (only models with the [AUTO POWER OFF] function).
  - [OFF TIMER] is turned off (only models with the [OFF TIMER] function).

### Video and Audio

- No image is displayed from your PC or video equipment to the projector.
  - Still no image even though you connect the projector to the PC first, then start the PC.
  - Enabling your notebook PC’s signal output to the projector.
    - *A combination of function keys will enable/disable the external display. Usually, the combination of the “Fn” key along with one of the 12 function keys turns the external display on or off.*
  - No image (blue or black background, no display).
  - Still no image even though you press the AUTO ADJUST button.
  - Still no image even though you carry out [RESET] in the projector’s menu.
  - Signal cable’s plug is fully inserted into the input connector
  - A message appears on the screen. (\_\_\_\_\_)
  - The source connected to the projector is active and available.
  - Still no image even though you adjust the brightness and/or the contrast.
  - Input source’s resolution and frequency are supported by the projector.
- Image is too dark.
  - Remains unchanged even though you adjust the brightness and/or the contrast.
- Image is distorted.
  - Image appears to be trapezoidal (unchanged even though you carry out the [KEYSTONE] adjustment).
- Parts of the image are lost.
  - Still unchanged even though you press the AUTO ADJUST button.
  - Still unchanged even though you carry out [RESET] in the projector’s menu.
- Image is shifted in the vertical or horizontal direction.
  - Horizontal and vertical positions are correctly adjusted on a computer signal.
  - Input source’s resolution and frequency are supported by the projector.
  - Some pixels are lost.
- Image is flickering.
  - Still unchanged even though you press the AUTO ADJUST button.
  - Still unchanged even though you carry out [RESET] in the projector’s menu.
  - Image shows flickering or color drift on a computer signal.
  - Still unchanged even though you change [FAN MODE] from [HIGH ALTITUDE] to [AUTO].
- Image appears blurry or out of focus.
  - Still unchanged even though you checked the signal’s resolution on PC and changed it to projector’s native resolution.
  - Still unchanged even though you adjusted the focus.
- No sound.
  - Audio cable is correctly connected to the audio input of the projector.
  - Still unchanged even though you adjusted the volume level.
  - AUDIO OUT is connected to your audio equipment (only models with the AUDIO OUT connector).

### Other

- Remote control does not work.
  - No obstacles between the sensor of the projector and the remote control.
  - Projector is placed near a fluorescent light that can disturb the infrared remote controls.
  - Batteries are new and are not reversed in installation.
- Buttons on the projector cabinet do not work (only models with the [CONTROL PANEL LOCK] function)
  - [CONTROL PANEL LOCK] is not turned on or is disabled in the menu.
  - Still unchanged even though you press and hold the EXIT button for a minimum of 10 seconds.



---

## **⑩ REGISTER YOUR PROJECTOR! (for residents in the United States, Canada, and Mexico)**

Please take time to register your new projector. This will activate your limited parts and labor warranty and Peace-of-Mind service program.

Visit our web site at [www.dukaneav.com](http://www.dukaneav.com).

**DUKANE CORP AV SERVICE DEPT**  
2900 Dukane Drive  
St Charles, IL 60174  
800-676-2487 / 630-762-4032  
Fax 630-584-5156  
[avservice@dukane.com](mailto:avservice@dukane.com)  
[www.dukaneav.com](http://www.dukaneav.com)

***DUKANE***

**DUKANE CORP AV SERVICE DEPT**

2900 Dukane Drive  
St Charles, IL 60174  
800-676-2487 / 630-762-4032  
Fax 630-584-5156  
avservice@dukane.com  
www.dukaneav.com