

## MultiPresenter application (for Windows/OS X)

# User manual

Compatible with Ver. 1.0.0



### Table of contents

1. Overview of MultiPresenter.....	2
1-1. Features .....	2
1-2. Operating conditions.....	3
2. Installation/Uninstallation .....	3
2-1. Installation.....	3
2-2. Uninstallation.....	3
3. Menu icon .....	4
4. Connecting the MultiPresenter Stick or projector .....	5
4-1. Using Smart Connection.....	5
4-2. Using SIMPLE ACCESS POINT or INFRASTRUCTURE.....	5
5. Description of menu icon .....	6
5-1. Status display.....	6
5-2. Target Device.....	6
5-3. Full Screen/Split Screen .....	7
5-4. Suspend/Resume .....	8
5-5. Lock Screen/Unlock Screen .....	8
5-6. Hide the connection information/Show the connection information.....	8
5-7. Settings .....	8
5-8. Quit.....	9
6. Edit Connection List.....	10
6-1. Edit/Import/Export screen .....	10
6-2. Select Groups for Search screen.....	11
7. Trademarks.....	12

# 1. Overview of MultiPresenter

## 1-1. Features

### ● Transmission of picture and sound

MultiPresenter (hereinafter called as “the app”) can transmit computer audio and video data (audio can be transmitted only when using Windows) via a wireless LAN and can indicate them on a display or projector by using our MultiPresenter Stick (DS1-MP10RX series) to the wireless LAN.

In addition, when you use a projector supporting the app, computer audio and video data (audio can be transmitted only when using Windows) can be transmitted via a wireless LAN or wired LAN without using the MultiPresenter Stick.

In some parts of this document, the MultiPresenter Stick and projectors are called collectively as “receiving devices”

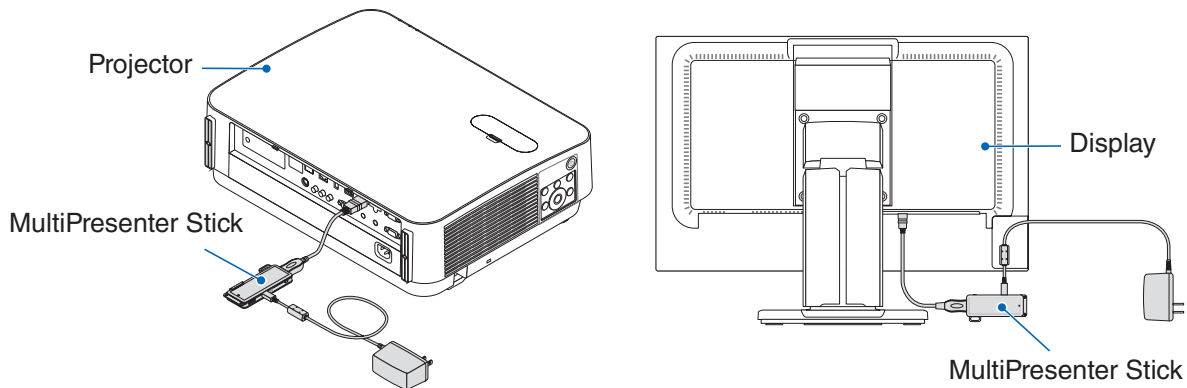

### ● Multi-screen display

When this app is started on multiple computers, pictures transmitted to a single receiving device from each computer can be displayed in a multi-screen display. The maximum of 16 screens (4 rows × 4 columns) can be displayed at the same time. In this case, the receiving device needs to be compatible with “Multi-Screen Display”.

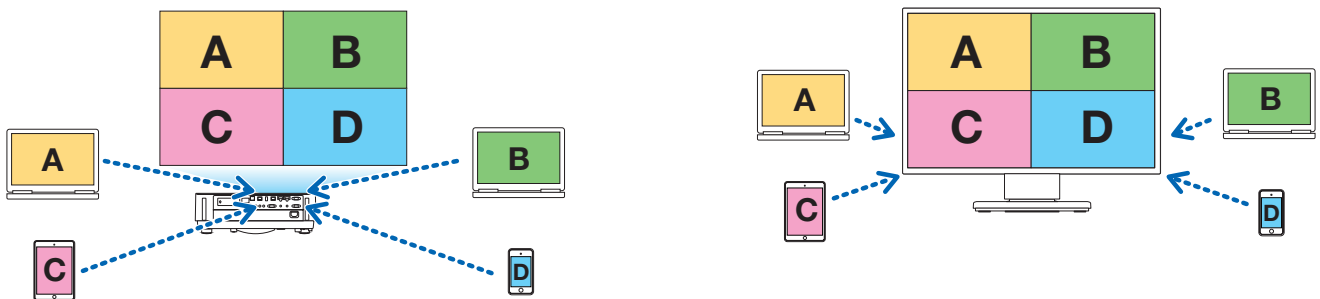

### ● Simultaneous display of multiple receiving devices

A picture can be transmitted to multiple receiving devices (the maximum of about 5 devices) from the app and displayed on each receiving device.

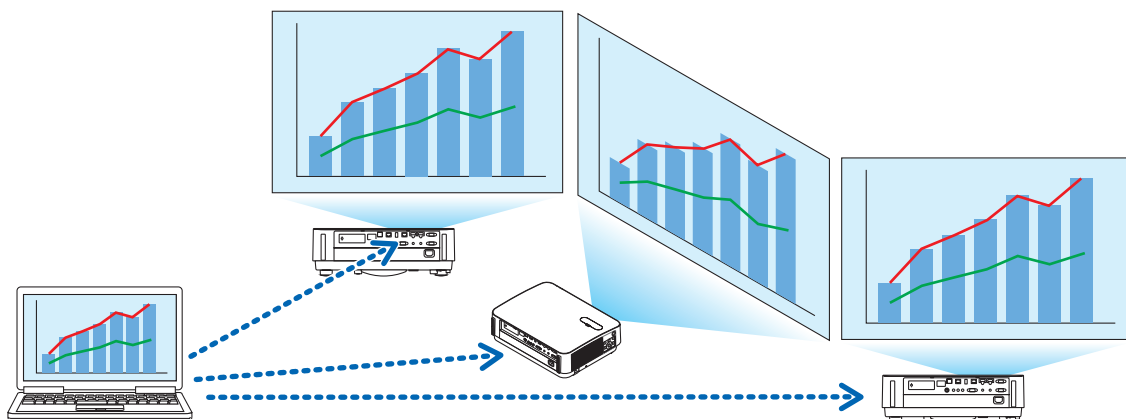

### ● Smart Connection

Supports “Smart Connection” which allows the device to be connected via a wireless LAN with minimum operations by entering a PIN code (4-digit number).

When connecting devices by Smart Connection, set the profile of the wireless LAN of the MultiPresenter Stick or projector to “Smart Connection”.

\*: Limited to models that support “Smart Connection”.

### ● Projector control function

When connected to a projector, you can turn off the power of the projector, switch the source terminal, control the picture, adjust the volume, disconnect the communications, and perform other controls from the target device window of the app.

### ● Available in 11 languages

The menus and guide messages can be displayed in the following 11 languages.

English, Japanese, Chinese (Simplified), French, German, Italian, Spanish, Portuguese, Swedish, Russian, Korean

Note: The installer is displayed in English only.

### ● Supported multiple OS

Besides the apps for Windows and OS X, the apps for Android and iOS are also available.

Download the app for Android from Google Play and the app for iOS from the App Store.

## 1-2. Operating conditions

Supporting models	MultiPresenter Stick (DS1-MP10RX series) Our projector supporting MultiPresenter
Supporting OS	Windows 10, Windows 8.1, Windows 7 OS X 10.7 to 10.11

Please visit the MultiPresenter home page for more details.

## 2. Installation/Uninstallation

Download the installer file for this app from the home page of MultiPresenter. Or you can also download it from the WEB server of the MultiPresenter Stick.

### 2-1. Installation

#### 2-1-1. For Windows

① Download “MultiPresenter\_Win\_Installer\_xxx.exe” to your computer.

② Double-click “MultiPresenter\_Win\_Installer\_xxx.exe”.

Thereafter, follow the operating instructions displayed on the screen.

When the installation is complete, the short cut icon of MultiPresenter will appear on the desktop.

#### 2-1-2. For OS X

① Download “MultiPresenter\_Mac\_xxx.zip” to your computer.

② Decompress “MultiPresenter\_Mac\_xxx.zip”.

③ Double-click “MultiPresenter.dmg”.

④ Drag and drop “MultiPresenter” in the expanded window into “Applications” folder.

### 2-2. Uninstallation

#### 2-2-1. For Windows

① Display the Windows “Control Panel”.

② Click on “Programs and Features” or “Programs”.

③ Select “MultiPresenter” and click “Uninstall”.

#### 2-2-2. For OS X

① Select “MultiPresenter” in the application folder and put it into “Trash”.

### 3. Menu icon

The menu icon of the app changes as follows according to the status of the connection with the receiving device. The icons under the Status display icon are called as functional icons. The functional icon will be displayed/hidden each time you click on the Status display icon. The settings window can be displayed/hidden by clicking the Target device icon or the Settings icon.

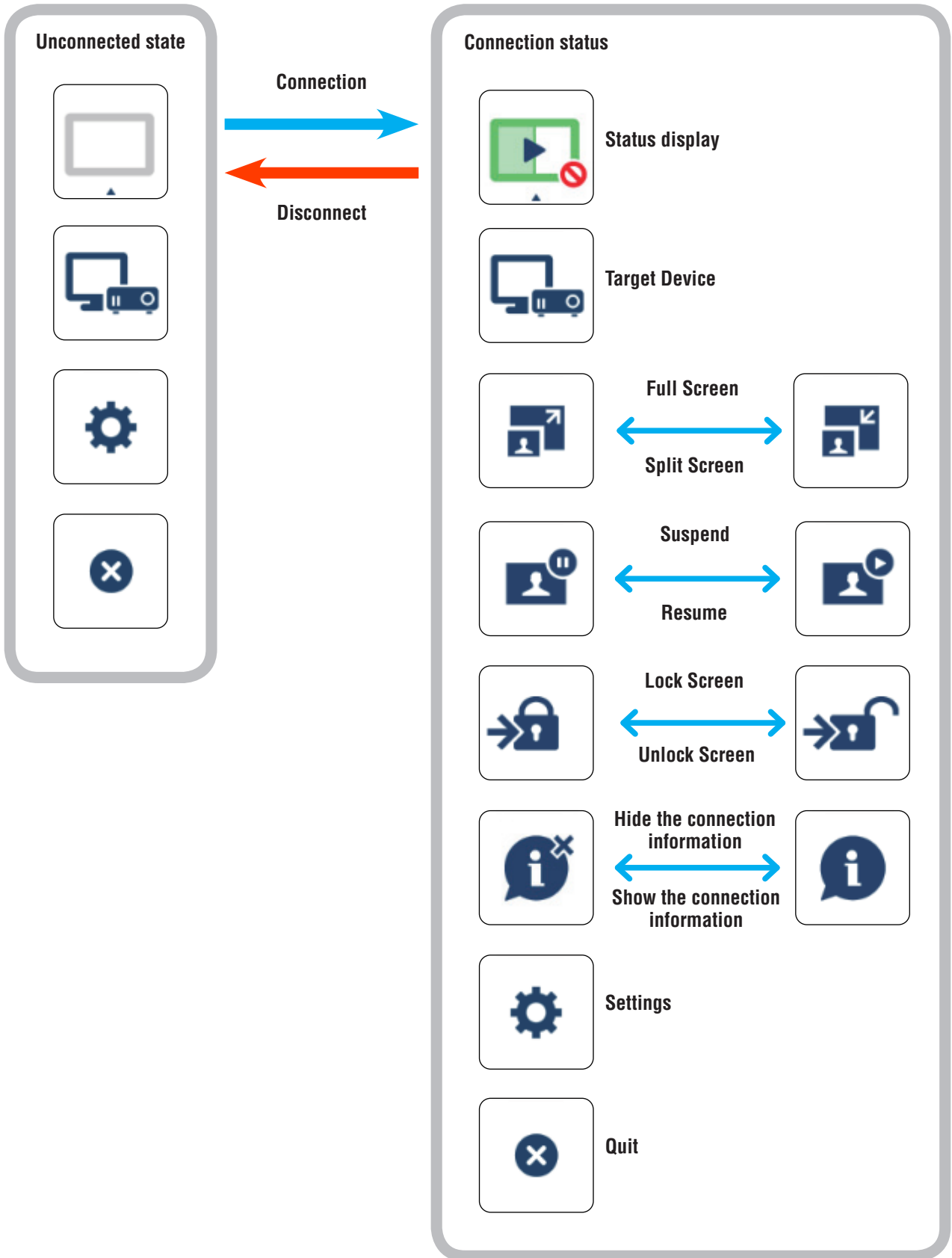

## Caution

- When the app and receiving device are connected one-to-one, “Full Screen/Split Screen” cannot be selected.
- When another MultiPresenter user selects “Lock Screen” or sets the MultiPresenter mode to [MANAGED] under the WEB server settings of the MultiPresenter Stick, “Full Screen/Split Screen”, “Lock Screen/Unlock Screen”, and “Hide the connection information/Show the connection information” cannot be selected.
- When a receiving device that does not support “Multi-Screen Display” is connected, or when multiple receiving devices are connected, “Full Screen/Split Screen”, “Suspend/Resume”, and “Hide the connection information/Show the connection information” do not appear.

## 4. Connecting the MultiPresenter Stick or projector

### 4-1. Using Smart Connection

#### 4-1-1. Connecting with the MultiPresenter Stick

- ① Connect the MultiPresenter Stick to the display or projector and turn on the power to display the Start-up screen. For step-by-step instructions, refer to the Quick Setup Guide of the MultiPresenter Stick.
- ② Start the app. The target device window appears.
- ③ Enter the PIN code displayed on the Start-up screen to the target device window. When the connection with the MultiPresenter Stick is complete, the computer screen will be transmitted and displayed on the connected display or projector.



#### 4-1-2. Connecting with the projector

- ① Connect the wireless LAN unit to the projector and turn on the power.
- ② Display the NETWORK SETTING either on the onscreen menu of the projector or the HTTP server, and then change the wireless LAN profile to “Smart Connection”.
- ③ Switch the input terminal of the projector to “LAN”. The PIN code will be displayed on the projection screen. The PIN code will also appeared on the [INFORMATION] screen of the on-screen menu.
- ④ Start the app. The target device window appears.
- ⑤ Enter the PIN code displayed on the projection screen to the target device window. When the connection with the projector is complete, the computer screen will be transmitted and displayed on the connected projector.

### 4-2. Using SIMPLE ACCESS POINT or INFRASTRUCTURE

#### 4-2-1. Connecting with the MultiPresenter Stick

- ① Connect the MultiPresenter Stick to the display or projector and turn on the power to display the Start-up screen. For step-by-step instructions, refer to the Quick Setup Guide of the MultiPresenter Stick.
- ② Display the settings menu of the MultiPresenter Stick and change the profile of the wireless LAN. For step-by-step instructions, refer to the Important Information of the MultiPresenter Stick.
- ③ Follow the “Connection Instructions” appearing on the Start-up screen to connect your computer to the MultiPresenter Stick.
- ④ Start the app. The target device window appears.

- ⑤ Choose [Select] for assigning the receiving device on the list.  
When the connection with the MultiPresenter Stick is complete, the computer screen will be transmitted and displayed on the connected display or projector.

#### 4-2-2. Connecting with the projector







- ① Connect the wireless LAN unit or LAN cable to the projector and turn on the power.
- ② Display the network settings screen in the HTTP server or on-screen menu of the projector and change the profile of the wired or wireless LAN.  
Refer to the User's manual of the projector for the procedure.
- ③ Follow the network settings displayed on the [INFORMATION] screen of the on-screen menu of the projector to connect your computer to the projector.
- ④ Start the app.  
The target device window appears.
- ⑤ Choose [Select] for assigning the receiving device on the list.  
When the connection with the projector is complete, the computer screen will be transmitted and displayed on the connected projector.

### 5. Description of menu icon

#### 5-1. Status display

Indicates the status of the app.

Click the status display icon to display/hide the functional icon below it.

Icon display	Status
	Indicates that a receiving device such as the MultiPresenter Stick or projector etc. has not been connected yet.
	Indicates that a receiving device has been connected. Different colors on the left and right of the icon indicate that "Multi-Screen Display" is supported.  indicates that "Full Screen" and "Hide the connection information" cannot be selected.  indicates the Lock Screen status.
	Indicates that the transmission of pictures by the app is stopped temporarily (Suspend).
	Indicates that multiple receiving devices are connected at the same time. Or that a receiving device that does not support "Multi-Screen Display" is connected.

#### 5-2. Target Device

This window is used to connect the app to the MultiPresenter Stick or a projector.

There are two tabs, "Connection" and "Control".

The various buttons under the Control tab are enabled when a projector is connected. When the MultiPresenter Stick is connected, only the "Update "; "Disconnect" and "Browser Server" buttons will be enabled.

#### [Connection] tab

PIN code	Enter the PIN code (4-digit number) displayed on the receiving device. The PIN code can also be entered by the computer keyboard.
----------	---

Select	<p>Displays a list of the receiving devices found on the same network or those registered in the connection list.</p> <p>Click the name of the device to connect.</p> <ul style="list-style-type: none"> <li>• When you click “Multiple,” a check box will appear to the left of the receiving device list.</li> <li>• Click  to update the list.</li> <li>• When a device is connected, a ☆ mark will appear on the right side of the device name. When the ☆ mark is clicked, it will turn yellow and the device name will be registered in “Favorite.”</li> <li>• Click “Search by IP address” to display the input screen. Enter the IP address of the device you want to connect in the “XXX.XXX.XXX.XXX” format.</li> <li>• Refer to Page 10 for the “Edit Connection List”.</li> </ul>
Favorite	<p>A list of the devices whose ☆ mark has turned yellow will be displayed.</p> <p>When the ☆ mark is clicked and turns from yellow to white, the device name will be deleted from “Favorite.”</p>
History	<p>A list of device names that have been connected in the past will be displayed (maximum of 10 names). The names will appear in descending order with the device that was last connected on top.</p>
User Name	<p>Click User Name to display the edit screen for editing the User Name. Use 0-32 characters for the User Name.</p>
Suspend after connection	<p>Setting on whether to Suspend after connection to a receiving device or not. (Initial value is off)</p>
Disconnect All	<p>Appears when connected to a receiving device and when selected, communications will be disconnected.</p>

**[Control] tab**

Picture	Mute (Not display picture) or freeze (still) the display.
Sound	Mute or play back the sound.
Volume	Move the slider bar to adjust the volume.
Source	<p>The input terminals can be displayed and switched.</p> <p>Only 3 languages can be displayed - English, Japanese and Chinese (simplified). For all other languages, the display will appear in English.</p>
Power off	Turns off the power of the projector to switch to the standby mode.
Disconnect	Disconnects the communications with the receiving device.
Browse Server	Displays the WEB server or HTTP server of the receiving device connected in the network.

**5-3. Full Screen/Split Screen**

When transmitting pictures from multiple MultiPresenters to a single receiving device, select whether to display the pictures that you transmitted in a Full Screen or split screen.

**Caution**

“Full Screen/Split Screen” cannot be selected in the following cases.

- When the receiving device connected does not support “Multi-Screen Display”.
- When “Lock Screen” is selected for the MultiPresenter of another user.
- When the app is connected to one or multiple receiving devices.
- When the MultiPresenter is set to the [MANAGED] mode under the “SETTINGS” of the WEB server of the MultiPresenter Stick.

## 5-4. Suspend/Resume

Select either to stop temporarily (Suspend) or to restart transmission (Resume).

### Caution

“Suspend/Resume” cannot be selected in the following cases.

- When the receiving device connected does not support “Multi-Screen Display”
- When the app is connected to multiple receiving devices.

## 5-5. Lock Screen/Unlock Screen

Select either to lock (prohibit) or unlock (permit operation) to the receiving device from the MultiPresenter for another user.

### Caution

“Lock Screen/Unlock Screen” cannot be selected in the following cases.

- When the picture being transmitted from the app is not displayed in Full Screen.
- When “Lock Screen” is selected for the MultiPresenter of another user.
- When the MultiPresenter is set to the [MANAGED] mode under the “SETTINGS” of the WEB server of the MultiPresenter Stick.

## 5-6. Hide the connection information/Show the connection information

Select either to display or hide the connection information (PIN code, SSID, security key, device name, WEB server URL) on the screen of the receiving device.

### Caution

“Hide the connection information/Show the connection information” cannot be selected in the following cases.

- When “Lock Screen” is selected for the MultiPresenter of another user.
- When the MultiPresenter is set to the [MANAGED] mode under the “SETTINGS” of the WEB server of the MultiPresenter Stick.
- The connection information may not appear depending on the receiving device.

## 5-7. Settings

Configure the settings of the app.

There are 4 tabs - “Picture”, “Sound”, “Search” and “About”.

The “Sound” tab appears only in Windows.

### [Picture] tab

Picture Quality	Sets the picture quality of the picture to transmit. Transmission speed increases as the picture quality is lowered.
Maximum Frame Rate	Sets the Maximum Frame Rate of the picture to transmit.
Enlarge the transmitting image to the output resolution	Sets whether to expand the resolution of the picture to transmit according to the output resolution of the receiving device. (Initial value is ON)
Use Windows Aero	Setting on whether to use Windows Aero or not. This can be set only when using Windows 7. (Initial value is ON) When this setting is set to OFF, the app will switch to Windows Basic when started. Returns to Windows Aero when you quit the app.
Transmit layered window	Setting on whether to transmit layered window or not. This can be set only when using Windows 7. (Initial value is ON)
Always show MultiPresenter on top	Setting on whether to always show MultiPresenter on top or not. (Initial value is off)



**[Sound] tab**

Transmit the desktop sound	Setting on whether to transmit sound or not. (Initial value is ON)
Sound Source	Selects the sound source. Click ▼ on the left side to display a list of the audio sources.
Latency	Sets the latency when transmitting sound.

**[Search] tab**

Search the local network by the broadcast	Setting on whether to search the local network using a broadcast or not when inspecting a receiving device. (Initial value is ON)
Search by the connection list	Setting on whether to search by the connection list when searching for receiving devices or not. (Initial value is ON)

**[About] tab**

Version	The version of the software will be displayed under “MultiPresenter”
Licenses	Displays the Licenses screen.
Check the Latest Version	Displays the latest version confirmation screen. When checking for the latest version, you need to connect to the Internet in order to access the home page of the app.

**5-8. Quit**

Quits the app.

Returns to the original wireless LAN setting when you are connected to the receiving device with “Smart Connection”

## 6. Edit Connection List

When using the connection list, multiple receiving devices can be grouped for management purposes. For example, when installing receiving devices in each meeting room or classroom and so on, it is convenient to search receiving devices quickly if the IP address of each receiving device is registered in the connection list in advance.

By the registration, the app automatically searches devices. You can also narrow down the receiving devices that you want to find in a group.

In addition, you can also Export the connection list as a file or Import it to another computer or smart phone and so on for sharing purposes.

### 6-1. Edit/Import/Export screen

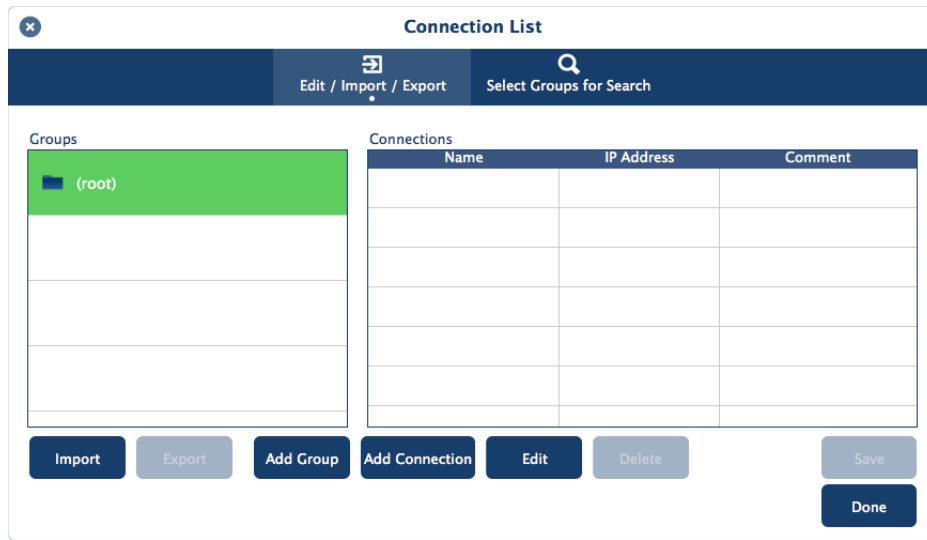

Group list	Displays the groups by level. The number of groups is limited to the maximum of 100, with the maximum of 5 levels.
Connection List	Displays the list of receiving devices in the selected group. The maximum number of connections is up to 2000. Connections can be moved to an other group by drop and drop the connection list.
Add Group	Adds a group. 1 - 64 characters can be entered.
Add Connection	Adds a connection (name, IP address of the receiving device, comment) to the selected group. 0 - 32 characters can be entered for the name and comment. Enter the IP address in the "XX.XXX.XXX.XXX" format.
Edit	Edits the added group or connection.
Delete	Deletes the added group or connection.
Save	Saves the edited connection list to your computer.
Done	Ends to edit the connection list.
Export	Exports the edited connection list as a file. The file extension is "ncp".
Import	Imports the file of the connection list. Only files with the file extension "ncp" can be imported.

## 6-2. Select Groups for Search screen

Group list	Adds check marks to the groups subject to the search.
Uncheck All	Removes all check marks.
Check All	Adds check marks to all groups.
Done	Ends Select Groups for Search.

### Caution

- The connection list of the app is not compatible with the Connection Target List of Image Express Utility 2.0 and Image Express Utility Lite.

## 7. Trademarks

- MultiPresenter is a trademark or registered trademark of NEC Display Solutions, Ltd. in Japan and other countries.
- Windows is a registered trademark or trademark of Microsoft Corporation in the United States and other countries.
- Android and Google Play are registered trademarks or trademarks of Google Inc.
- OS X is a trademark of Apple Inc. registered in the US and other countries.
- iOS is a trademark or registered trademark of Cisco in the United States and other countries, which is used under license.
- App Store is a service mark of Apple Inc.
- Other manufacturer names and product names mentioned in the instruction manual are registered trademarks or trademarks of their respective companies.

### Things to note

- (1) Unauthorized copying of a portion or all of the contents of this document is prohibited.
- (2) The contents of this document are subject to change without prior notice.
- (3) All efforts have been made to ensure the contents of this document are correct. Please contact us should you have any questions or notice any errors or omissions.
- (4) Terms notwithstanding (3), please note that our company will not be liable in any way whatsoever for any damages or lost profits etc. incurred as a result of using this document.