

Thank you for purchasing this product.

This is the basic manual on the product.



Visit our website to get the detailed manuals and the latest information on the product. Check them before using the product, for safe use and utilization of the product.

**Our website: <http://www.dukaneav.com>**

**⚠WARNING** ▶ Before using this product, be sure to read all manuals for this product. After reading them, store them in a safe place for future reference.  
▶ Heed all the warnings and cautions in the manuals or on the product.  
▶ Follow all the instructions in the manuals or on the product.

**NOTE** • In this manual, unless any comments are accompanied, “the manuals” means all the documents provided with this product, and “the product” means this projector and all the accessories came with the projector.

## Contents

			
First of all.....	2	Turning on the power.....	11
Entries and graphical symbols explanation .....	2	Adjusting the projector's elevator .....	12
Important safety instruction .....	2	Operation.....	12
Regulatory notices.....	3	Turning off the power.....	14
About Electro-Magnetic Interference .....	3	Cleaning and replacing the air filter..	15
Disposal of Old Equipment and Batteries		Replacing the internal clock battery..	16
Only for European Union and countries with		Caring for the projection window .....	17
recycling systems .....	5	Specifications .....	18
Contents of package.....	5	Troubleshooting	
Arrangement.....	6	- Warranty and after-service .....	19
Connecting with your devices.....	7		
Connecting to a power supply .....	9		
Preparing for the remote control.....	10		

# First of all

## Entries and graphical symbols explanation

The following entries and graphical symbols are used for the manuals and the product as follows, for safety purpose. Please know their meanings beforehand, and heed them.

- ⚠WARNING This entry warns of a risk of serious personal injury or even death.
- ⚠CAUTION This entry warns of a risk of personal injury or physical damage.
- NOTICE This entry notices of fear of causing trouble.

## Important safety instruction

The following are important instructions for safely using the product. Be sure to follow them always when handling the product. The manufacturer assumes no responsibility for any damage caused by mishandling that is beyond normal usage defined in these manuals of this projector.

- ⚠WARNING ▶ Never use the product in or after an abnormality (ex. giving off smoke, smelling strange, took a liquid or an object inside, broken, etc.) If an abnormality should occur, unplug the projector urgently.
- ▶ Situate the product away from children and pets.
- ▶ Do not use the product when there is fear of a thunderbolt.
- ▶ Unplug the projector from the power outlet if the projector is not used for the time being.
- ▶ Do not open or remove any portion of the product, unless the manuals direct it. For internal maintenance, leave it to your dealer or their service personnel.
- ▶ Use only the accessories specified or recommended by the manufacturer.
- ▶ Do not modify the projector or accessories.
- ▶ Do not let any things or any liquids enter to the inside of the product.
- ▶ Do not wet the product.
- ▶ Do not place the projector where any oils, such as cooking or machine oil, are used. Oil may harm the product, resulting in malfunction, or falling from the mounted position. Do not use adhesive such as threadlocker, lubricant and so on.
- ▶ Do not apply a shock or pressure to this product.
- Do not place the product on an unstable place such as the uneven surface or the leaned table.
- Do not place the product unstably. Place the projector so that it does not protrude from the surface where the projector is placed on.
- Remove all the attachments including the power cord and cables, from the projector when carrying the projector.
- ▶ Never look into the projection window while the projection light source is on, since the projection ray may cause a trouble on your eyes.
- ▶ Do not approach the exhaust vents, while the light source is on. Also after the light source goes out, do not approach them for a while, since it is too hot.

# Regulatory notices

## About Electro-Magnetic Interference

### In CANADA

CAN ICES-3(B) / NMB-3(B).

### In the US, and other places where the FCC regulations are applicable

#### **Declaration of Conformity**

Trade name	HITACHI / DUKANE
Model Number	LP-AW3001 - 8133WSS / LP-AW4001 - 8142WSS
Responsible Party	Hitachi America, Ltd.
Address	2420 Fenton Street, Suite 200 Chula Vista, CA 91914 U.S.A.
Telephone Number	+1 -800-448-2244

This device complies with part 15 of the FCC Rules. Operation is subject to the following two conditions: (1) This device may not cause harmful interference, and (2) this device must accept any interference received, including interference that may cause undesired operation. This equipment has been tested and found to comply with the limits for a Class B digital device, pursuant to Part 15 of the FCC Rules.

These limits are designed to provide reasonable protection against harmful interference in a residential installation. This equipment generates, uses, and can radiate radio frequency energy and, if not installed and used in accordance with the instructions, may cause harmful interference to radio communications. However, there is no guarantee that interference will not occur in a particular installation. If this equipment does cause harmful interference to radio or television reception, which can be determined by turning the equipment off and on, the user is encouraged to try to correct the interference by one or more of the following measures:

- Reorient or relocate the receiving antenna.
- Increase the separation between the equipment and receiver.
- Connect the equipment into an outlet on a circuit different from that to which the receiver is connected.
- Consult the dealer or an experienced radio/TV technician for help.

**INSTRUCTIONS TO USERS:** This equipment complies with the requirements of FCC (Federal Communication Commission) equipment provided that the following conditions are met. Some cables have to be used with the core set. Use the accessory cable or a designated-type cable for the connection. For cables that have a core only at one end, connect the core to the projector.

**CAUTION:** Changes or modifications not expressly approved by the party responsible for compliance could void the user's authority to operate the equipment.

**Note:** The Dukane models described in this document are manufactured by Hitachi and uses the same firmware, software programs, control code, and accessory parts. The equivalent Dukane to Hitachi models are 8133WSS (LP-AW3001) and 8142WSS (LP-AW4001).

## Regulatory notices (continued)

### Product label

The position of the label is shown in the drawing below.

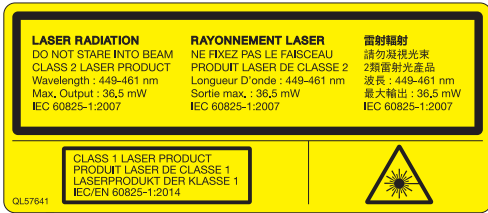

As with any bright source, do not stare into the direct beam, RG2 IEC 62471-5:2015.

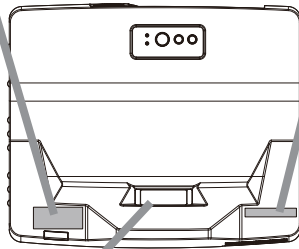
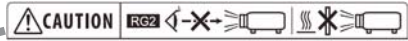

Laser Aperture

Laser evaluation standard:  
IEC60825-1: 2007, IEC60825-1: 2014,  
EN60825-1: 2014

LP-AW4001:

Internal Laser Specifications

Max. Output: 95W

Wave Length: 449 - 461nm

LP-AW3001/LP-AX3001:

Internal Laser Specifications

Max. Output: 71W

Wave Length: 449 - 461nm

- This projector is classified as a class 1 laser product that complies with IEC60825-1:2014 and JIS C 6802:2014, and as a class 2 laser product that complies with IEC60825-1:2007. Improper handling may cause injury. Be careful of the following.
- If an abnormality occurs in the projector, turn it off immediately, unplug the power cord from the outlet, and consult your dealer or service company. If you continue to use it, it may cause not only electric shock or fire but also vision disorder.
- Do not disassemble or modify the projector. The projector has a high-power laser device inside. It may cause serious injury.
- Do not look into the beam while projecting an image. Do not look into the lens through optical devices such as magnifiers or telescopes. It may cause vision disorder.
- Make sure that nobody is looking into the lens when you turn on the projector by remote control away from the projector.
- Do not let children operate the projector. If children could possibly operate the projector, they must be accompanied by an adult.
- Do not expose optical devices such as magnifiers or reflection mirrors to a projected image. It may cause bad effects on the human body if you continue to use it. It may also cause fire or accidents.
- Do not disassemble the projector when you dispose of it. Dispose of it according to laws and regulations of each country or region.

⚠ CAUTION ► Use of controls or adjustments or performance of procedures other than those specified herein may result in hazardous radiation exposure.

## Regulatory notices (continued)

### Disposal of Old Equipment and Batteries Only for European Union and countries with recycling systems



The above mark is in compliance with the Waste Electrical and Electronic Equipment Directive 2012/19/EU (WEEE). The mark indicates the requirement NOT to dispose the equipment including any spent or discarded batteries as unsorted municipal waste, but use the return and collection systems available. If the batteries or accumulators included with this equipment display the chemical symbol Hg, Cd, or Pb, then it means that the battery has a heavy metal content of more than 0.0005% Mercury, or more than 0.002% Cadmium or more than 0.004% Lead.



Note for the battery symbol (bottom symbol): This symbol might be used in combination with a chemical symbol. In this case it complies with the requirement set by the Directive for the chemical involved.

## Contents of package

Your projector should come with the items shown below. Check that all the items are included. Contact your dealer immediately if any items are missing.

Refer to figure **F-7** at the back of this manual.

- |  |                              |
|--|------------------------------|
| (1) Remote control with two AA batteries | (8) Screw                    |
| (2) Power cord                           | (9) HDMI cable holder (x2)   |
| (3) Computer cable                       | (10) Cable tie - large (x1)  |
| (4) Support Sheet *                      | (11) Cable tie - medium (x2) |
| (5) Security label                       | (12) Cable tie - small (x1)  |
| (6) Adapter cover                        | (13) Ferrite core            |
| (7) Hook metal                           |                              |

\* The accessory book "User's Manual (concise)" is a basic manual. Read the detailed manuals ("Operating Guide" etc.) from our website. (📖 7).

**⚠️WARNING** ► Do not attempt to install the projector yourself. Have your dealer or service center handle all installation work. Note that manufacturer will accept no liability whatsoever for accidents or injuries resulting from an incorrect installation or improper use.

**⚠️CAUTION** ► If the disc comes with this product, use it in a computer disc drive. Never insert the disc into a non-computer disc drive. Inserting the disc into an incompatible disc drive may produce a loud noise and result in ear and speaker damage.

**NOTE** • Keep the original packing materials for future reshipment. Be sure to use the original packing materials when moving the projector. Use special caution for the lens.

# Arrangement

Refer to tables **T-1** and **T-2** and figures **F-1** and **F-2** at the end of this manual to determine the screen size and projection distance.

The values shown in the table are calculated for a full size screen.

Ⓐ Screen size (diagonal)    Ⓑ1, Ⓑ2 Projection distance (±8%)    Ⓒ1, Ⓒ2 Screen height (±8%)

- For the case of installation in special conditions such as on the wall or ceiling, the specified mounting accessories (📖 18) and service may be required. Before installing the projector, consult your dealer about your installation.
- The screen position may shift after installation if the projector is mounted on locations such as the wall or ceiling, due to the flexibility of the plastic projector body. If readjustment is necessary, consult with your dealer or service personnel.
- The projected image position and/or focus may change during warm-up (approx. 30 minutes after the light source is turned on) or when the ambient conditions change. Readjust the image position and/or focus as necessary.
- Since the projector features an ultra short throw, be aware that it is required to select a screen carefully to have better performance.
  - A soft screen such as a pull-down screen may cause serious distortion of a projected image. A hard screen such as a board screen is recommended for use with this projector.
  - A high-gain screen such as a bead screen that has narrow viewing angle is not suitable for this projector. A low-gain screen (around 1.0) such as a matte screen that has wide viewing angle is recommended for use with this projector.
  - A screen with a weave pattern may cause moire on the projected image, which is not a failure of the projector. A screen that has less moire effects is recommended for use with this projector.

⚠WARNING ▶ Install the projector in a stable horizontal position.

▶ Place the projector in a cool place, and ensure that there is sufficient ventilation.

Keep a space of 50 cm or more between the sides of the projector and other objects such as walls. Do not place or attach anything that would block the projection window or vent holes. Do not place the projector where the air from an air conditioner or similar unit will blow on it directly.

▶ Do not place the projector anywhere where it may get wet.

▶ Use only the mounting accessories the manufacturer specified, and leave installing and removing the projector with the mounting accessories to the service personnel.

▶ Read and keep the user's manual of the mounting accessories used.

⚠CAUTION ▶ Avoid placing the projector in smoky, humid or dusty place.

▶ Position the projector to prevent light from directly hitting the projector's remote sensor.

NOTE • Installation position, picture mode, altitude, and operating environment may affect the brightness of the display.

## Arrangement (continued)

### Connecting with your devices

Be sure to read the manuals for devices before connecting them to the projector. Make sure that all the devices are suitable to be connected with this product, and prepare the cables required to connect. Refer to figures **F-3** to **F-5** at the back of this manual.

For details, please see the "Operating Guide" and "Network Guide" from our website. (📖 7)

- When **AUTO** is selected for the **COMPUTER IN1** or **COMPUTER IN2** port in **COMPUTER IN** of the **INPUT** menu, that port will accept component video signals.
- To use network functions of the projector, connect the **LAN** port with the computer's LAN port, or with an access point that is connected to the computer with wireless LAN, using a LAN cable.
- If you insert a USB storage device, such as a USB memory, into the **USB TYPE A** port and select the port as the input source, you can view images stored in the device.

⚠️ **WARNING** ▶ Use only the appropriate accessories. Otherwise it could cause a fire or damage to the device and the projector.

- Use only the accessories specified or recommended by the projector's manufacturer. Consult your dealer when the required accessory did not come with the product or the accessory is damaged. It may be regulated under some standard.
- For a cable with a core at only one end, connect the end with the core to the projector. That may be required by EMI regulations.
- Neither disassemble nor modify the projector and the accessories.
- Do not use the damaged accessory. Be careful not to damage the accessories. Route a cable so that it is neither stepped on nor pinched out.

⚠️ **CAUTION** ▶ Do not turn on or off the projector while connected to a device in operation, unless that is directed in the manual of the device.

- ▶ Be careful not to mistakenly connect a connector to a wrong port.
- ▶ Before connecting the projector to a network, be sure to obtain the consent of the administrator of the network.
- ▶ Do not connect the **LAN** port to any network that might have the excessive voltage.
- ▶ The designated USB wireless adapter that is sold as an option is required to use the wireless network function of this projector.
- ▶ Before removing the USB storage device from the port of the projector, be sure to use the **REMOVE USB** function on the thumbnail screen to secure your data.
- ▶ Before you insert or pull out the USB wireless adapter from the projector, turn off the power of the projector and pull out the power cord's plug from the outlet. Do not touch the USB wireless adapter while the projector is receiving AC power.

(continued on next page)

## Connecting with your devices (continued)

**NOTICE** ► Use the cables with straight plugs, not L-shaped ones, as the input ports of the projector are recessed.

### Ferrite core for MHL cable

When connecting a MHL cable to this projector, attach the ferrite core that is supplied with the projector to the MHL cable.

Refer to the following figure to attach the core to the cable nearby one end of the cable firmly, and secure it using the cable tie.

Be sure to connect the end of the cable to the projector.

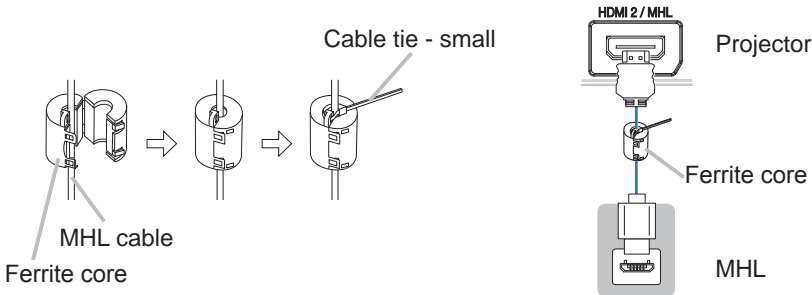

### Fastening the adapter cover

Use the supplied adapter cover to prevent the USB wireless adapter (optional) from coming off easily and prevention from burn injury.

1. Loosen the screw (marked with triangle) on the bottom left of the **USB TYPE A** port.
2. Insert the tab of the cover into the hole at the upper right of the **USB TYPE A** port in the direction of the arrow.
3. Align the screw holes on the projector and the cover. Then insert the screw removed from the projector into the hole and tighten the screw.

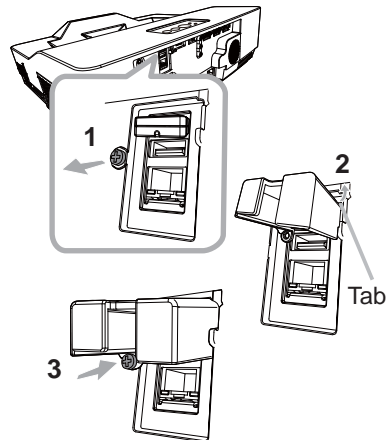

**⚠WARNING** ► Keep small parts away from children and pets. Take care not to put in the mouth. Heat may build up in the USB wireless adapter, so disconnect the projector power cord for more than 10 minutes before touching it to avoid possible burns.



## Connecting to a power supply

1. Put the connector of the power cord into the **AC** (AC inlet) of the projector.
2. Firmly plug the power cord's plug into the outlet. In a couple of seconds after the power supply connection, the **POWER/STATUS1** indicator will light up in steady orange.

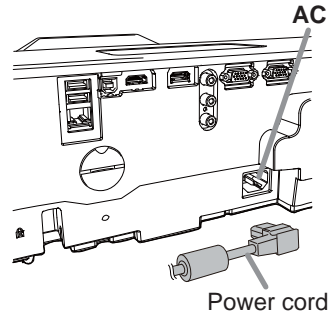

Please remember that when the **DIRECT POWER ON** function is activated, the connection of the power supply makes the projector turn on. When the **AUTO POWER ON** function is activated and the projector is receiving an input signal, it is turned on by connecting to the power supply.

**⚠WARNING** ► Please use extra caution when connecting the power cord, as incorrect or faulty connections may result in fire and/or electrical shock.

- Do not touch the power cord with a wet hand.
- Only use the power cord that came with the projector. If it is damaged, consult your dealer to get a new one. Never modify the power cord.
- Only plug the power cord into an outlet whose voltage is matched to the power cord. The power outlet should be close to the projector and easily accessible. Unplug the power cord for complete disconnection.
- Do not distribute the power supply to multiple devices. Doing so may overload the outlet and connectors, loosen the connection, or result in fire, electric shock or other accidents.
- Do not press the main body of projector on the power cord.
- Connect the ground terminal for the AC inlet of this unit to the ground terminal of the building using an appropriate power cord (bundled).

**NOTICE** ► This product is also designed for IT power systems with a phase-to-phase voltage of 220 to 240 V.

## Fastening the cable

Use the supplied cable tie to fasten the cable.

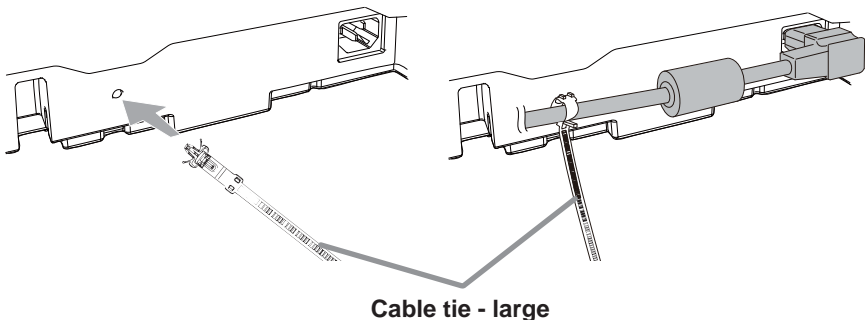

# Preparing for the remote control

Please insert the batteries into the remote control before using it. If the remote control starts to malfunction, try to replace the batteries. If you will not use the remote control for long period, remove the batteries from the remote control and store them in a safe place.

1. Remove the battery cover.
2. Align and insert the two AA batteries (Use the appropriate AA carbon-zinc or alkaline batteries (non-rechargeable) in accordance with laws and regulations.) according to their plus and minus terminals as indicated in the remote control.
3. Put the battery cover back to the former state.

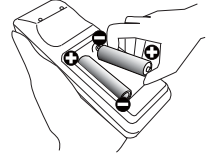

## NOTE

- Try changing the batteries when the remote control malfunctions.
- This remote control works with the remote sensors on the projector using infrared light (Class 1 LED). The active sensor senses the remote control signal assigned within 60 degrees to right and left, and within 3 meters. For details, see the "Operating Guide".
- Prevent the remote sensors from being hit by a strong ray. It may cause malfunction of the projector and remote control.

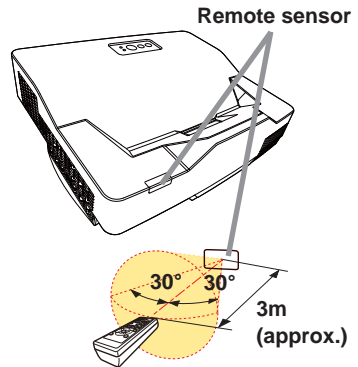

- ⚠WARNING** ► Always handle the batteries with care and use them only as directed. Improper use may result in battery explosion, cracking or leakage, which could result in fire, injury and/or pollution of the surrounding environment.
- Be sure to use only the batteries specified. Do not use batteries of different types at the same time. Do not mix a new battery with used one.
  - Make sure the plus and minus terminals are correctly aligned when loading a battery.
  - Keep a battery away from children and pets.
  - Do not recharge, short circuit, solder or disassemble a battery.
  - Do not place a battery in a fire or water. Keep batteries in a dark, cool and dry place.
  - If you observe battery leakage, wipe out the leakage and then replace a battery. If the leakage adheres to your body or clothes, rinse well with water immediately.
  - Obey the local laws on disposing the battery.

## Turning on the power

1. Make sure that the power cord is firmly and correctly connected to the projector and the outlet.
2. Make sure that the **POWER/STATUS1** indicator is steady orange.
3. Press the **STANDBY/ON** button on the projector or the remote control.  
The projection light source will light up, and the **POWER/STATUS1** indicator will begin blinking in green.  
When the power is completely on, the indicator will stop blinking and light in steady green.

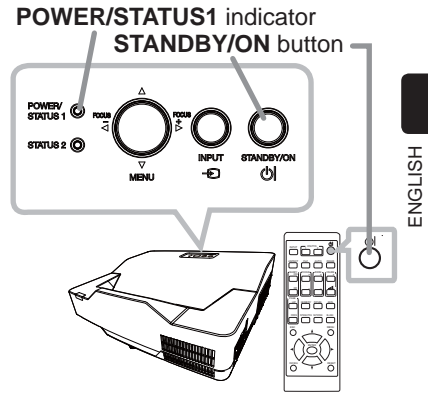

**△WARNING** ► Never look into the projection window while the projection light source is on, since the projection ray may cause a trouble on your eyes.

► Do not place the projector vertically as shown in the figure on the right. It could cause malfunction or injury. If you install the projector vertically on a table or desk, be sure to use the designated optional accessories.

► The projection window of this machine is made of glass. It can be damaged by excessive force or an impact. Read the following important warnings carefully, and follow them for your own safety.

- Do not apply excessive force on or allow impact to the projection window.
- Keep the projector out of the reach of children.
- If the projection window is broken, the projected image will be distorted. Never touch a broken projection window, and contact your dealer.

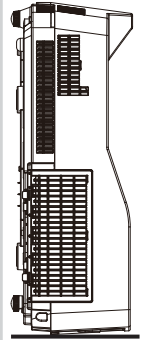

**NOTE** • Please power on the projector prior to the connected devices.  
• The projector has the **DIRECT POWER ON** function, which can make the projector automatically turn on. For more information, see the “Operating Guide”.

# Adjusting the projector's elevator

The projector has 2 Rear feet for adjusting the horizontal position and inclination. You can use the projector as it is with attached Spacers of Rear feet. You can make more precise adjustments by detaching the spacers and turning the Rear feet.

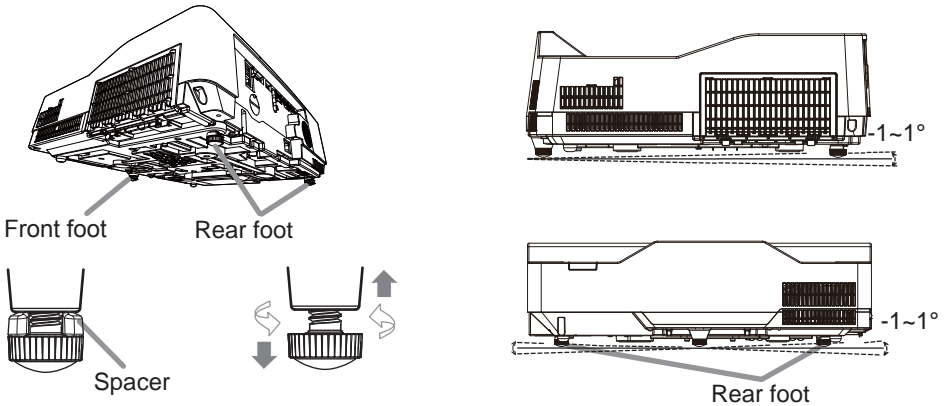

**△WARNING** ▶ Keep the spacers away from children and pets. Be careful not to let them swallow the spacers. If swallowed, consult a physician immediately for emergency treatment.

**NOTE** • The adjustment angle can be adjusted up to plus or minus  $1^\circ$  each of foot.

• You can attach the spacers to set the projector back to the factory default after adjusting the foot. If you install the projector in a different place in the future, it is recommended to keep the spacers and reuse them.

## Operation

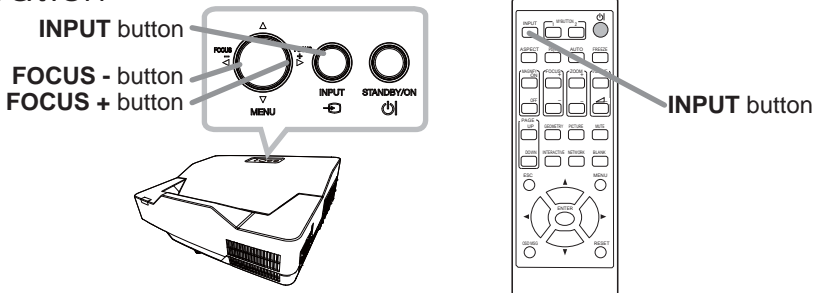

### Displaying and switching the image

Press the **INPUT** button on the projector or the remote control. Select a desirable input referring to the displayed input list.

(continued on next page)

## Focusing

Use the **FOCUS +** and **FOCUS -** buttons on the projector or remote control to adjust the screen focus.

## Selecting an aspect ratio

Each time you press the **ASPECT** button on the remote control, it switches the aspect ratio of the image in turn.

## Zooming

Use the **ZOOM +** and **ZOOM -** buttons on the remote control to adjust the screen size.

## Correcting distortion

Press the **GEOMETRY** button on the remote control. A dialog will appear on the screen to aid you in correcting the distortion.

Use the **▲/▼** cursor buttons to select, **KEYSTONE** or **PERFECT FIT** operation, and press the **▶** button to perform the following.

**KEYSTONE** displays a dialog for keystone correction.

**PERFECT FIT** displays a dialog for adjusting the shape of the projected image in each of the corners and sides.

Use the cursor buttons according to the dialog, checking the image.

Press the **GEOMETRY** button again to finish this operation.

## Adjusting the volume

Use the **VOLUME +/-** buttons to adjust the volume. To turn off the sound, press the **MUTE** button on the remote control.

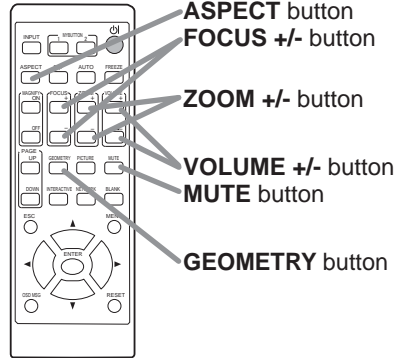

**⚠WARNING ▶** If you wish to have a blank screen while the light source is on, use the **BLANK** function (see the Operating Guide).

Any other method of blocking the projection light, such as attaching something to the projection window or placing something in front of the projection window, may cause the damage to the projector.

Blocking the beam by something causes high temperature and could result in fire or smoke.

(continued on next page)

NOTE • The **ASPECT** button does not work when no proper signal is input.

- For details, see the "Operating Guide".
- There may be some noise and/or the screen may flicker for a moment when an operation is made. This is not a malfunction.

## Turning off the power

1. Press the **STANDBY/ON** button on the projector or the remote control.  
The message "Power off?" will appear on the screen for about 5 seconds.
2. Press the **STANDBY/ON** button again while the message appears.  
The light source will go off, and the **POWER/STATUS1** indicator will begin blinking in orange. Then the **POWER/STATUS1** indicator will stop blinking and light in steady orange when the light source cooling is completed.

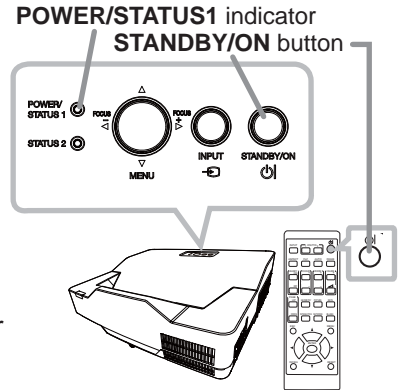

⚠WARNING ► Do not touch around the exhaust vents during use or just after use, since it is too hot.

► Unplug the power cord for complete disconnection. The power outlet should be close to the projector and easily accessible.

NOTE • Please power off the projector after any connected devices are powered off.

• This projector has the AUTO POWER OFF function that can make the projector turn off automatically. For more information, see the "Operating Guide".

## Cleaning and replacing the air filter

Please check and clean the air filter periodically. When the indicators or a message prompts you to clean the air filter, comply with it as soon as possible. In addition, the extra air filter is attached to inner side of the filter cover. If one of the filters is damaged or heavily soiled, replace whole filter set with a new one. Request for a filter set with the following type number from your dealer when purchasing a new one.

**Type number : UX43251 (Filter set)**

1. Turn the projector off, and unplug the power cord. Allow the projector to sufficiently cool down.
2. Use a vacuum cleaner on and around the filter cover.
3. Pick and pull up the filter cover knobs to take it off.
4. Press up slightly the bottom side knobs to unlock the bottom side of the filter unit. Take the filter unit off.
5. Use a vacuum cleaner for the filter vent of the projector and the outer side of the filter unit.
6. Use a vacuum cleaner for the inner side of each part of the filter unit to clean them up. If the filters are damaged or heavily soiled, replace them with the new ones.
7. Put the filter unit back in an upright state into the projector.
8. Put the filter cover back into the place.
9. Turn the projector on and reset the filter time using the FILTER TIME item in the EASY MENU.
  - (1) Press the **MENU** button to display a menu.
  - (2) Point at the FILTER TIME using the **▼/▲** button, then press the **▶** button. A dialog will appear.
  - (3) Press the **▶** button to select "OK" on the dialog. It performs resetting the filter time.

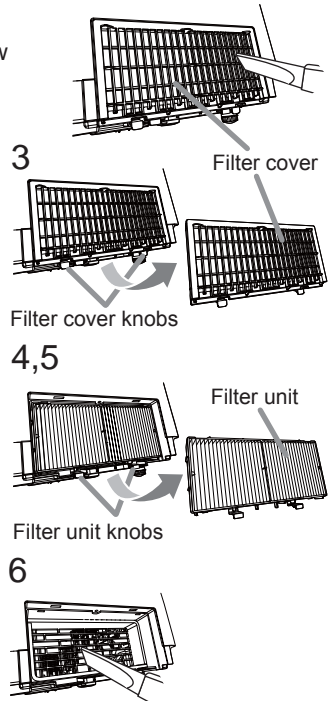

**△WARNING** ▶ Before taking care of the air filter, make sure the power cord is not plugged in, then allow the projector to cool sufficiently.

▶ Use only the air filter of the specified type. Do not use the projector without the air filter or the filter cover. It could result in a fire or malfunction to the projector.

▶ Clean the air filter periodically. If the air filter becomes clogged by dust or the like, internal temperatures rise and could cause a fire, a burn or malfunction to the projector.

**NOTE** • Please reset the filter time only when you have cleaned or replaced the air filter, for a suitable indication about the air filter.

• The projector may display the message such as the "CHECK THE AIR FLOW" or turn off the projector, to prevent the internal heat level rising.

# Replacing the internal clock battery

Installing the battery is required in some cases. (📖"Event Scheduling" in the "Network Guide") A battery is not contained at the time of factory shipment. Please replace a battery according to the following procedure.

1. Turn the projector off, and unplug the power cord.  
Allow the projector to cool sufficiently.
2. Turn the battery cover fully counterclockwise using a coin or the like, and pick the cover up to remove it.
3. Pry up the battery using a flathead screwdriver or the like to take it out. Do not use any metal tools. While prying it up, put a finger lightly on the battery since it may pop out of the holder.
4. Replace the battery with a new MAXELL, Part No.**CR2032** or **CR2032H**.  
Slide the battery in under the plastic claw, and push it into the holder until it clicks.
5. Replace the battery cover in place, then turn it clockwise to fix by using a coin or the like.

Battery Cover

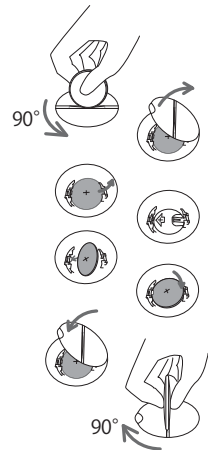
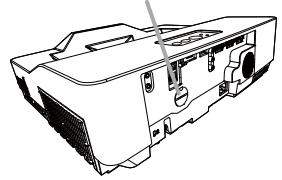

**⚠ WARNING** ▶ Always handle the batteries with care and use them only as directed. Battery may explode if mistreated. Do not recharge, disassemble or dispose of in fire.

And also improper use may result in cracking or leakage, which could result in fire, injury and/or pollution of the surrounding environment.

- Be sure to use only the specified batteries.
- Make sure the plus and minus terminals are correctly aligned when loading a battery.
- Keep a battery away from children and pets. If swallowed, consult a physician immediately for emergency treatment.
- Do not short circuit or solder a battery.
- Do not allow a battery in a fire or water. Keep batteries in a dark, cool and dry place.
- If you observe battery leakage, wipe out the leakage and then replace a battery. If the leakage adheres to your body or clothes, rinse well with water immediately.
- Obey the local laws on disposing a battery.



## Caring for the projection window

If the projection window is flawed, soiled or fogged, it could cause deterioration of display quality. Please take care of the projection window, being cautious of handling.

1. Turn the projector off and unplug the power cord from the power outlet. And cool the projector down by leaving it for a while.
2. Use an air blower to blow away dust on the projection window before wiping. Wipe softly the projection window with a commercially available dampened soft cleaning cloth for lens, being careful not to give any damage on the projection window.

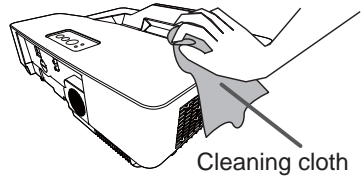
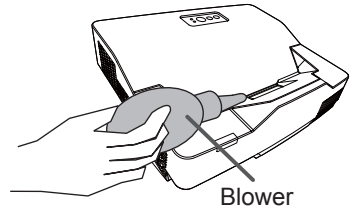

**⚠ WARNING** ▶ Before caring for the projection window, turn the projector off and unplug the power cord, then cool the projector sufficiently.  
▶ Do not use a vacuum cleaner to clean the projection window, since it might give some damage.  
▶ Do not use cleaners or chemicals other than those specified in this manual. Pay special attention to the projection window as these materials could cause serious damage.

# Specifications

Item	Specification																								
Product name	Liquid crystal projector																								
Liquid Crystal Panel	8133WSS/8142WSS: 1,024,000 pixels (1280 horizontal x 800 vertical) TBA: 786,432 pixels (1024 horizontal x 768 vertical)																								
Light Source	Laser Diode																								
Speaker	16W																								
Power supply	8133WSS: AC 100-120V/3.0A, AC 220-240V/1.5A 8142WSS: AC 100-120V/3.7A, AC 220-240V/1.9A																								
Power consumption	8133WSS: AC 100-120V:290 W, AC 220-240V:280W 8142WSS: AC 100-120V:360 W, AC 220-240V:350W																								
Temperature range	0 ~ 40°C (Operating) 35 ~ 40°C (The brightness of the light source is reduced automatically.)																								
Size	512 (W) x 155 (H) x 424 (D) mm 506 (W) x 139 (H) x 424 (D) mm * Not including protruding parts. Refer to figure <b>F-6</b> at the back of this manual.																								
Weight (mass)	8133WSS: approx. 7.4 kg 8142WSS: approx. 7.6 kg																								
Ports	<table border="0"> <tr> <td><b>Computer input port</b></td> <td><b>Audio input/output port</b></td> </tr> <tr> <td>COMPUTER IN1</td> <td>AUDIO IN1 ..... Stereo mini x1</td> </tr> <tr> <td>..... D-sub 15 pin mini x1</td> <td>AUDIO IN2 ..... Stereo mini x1</td> </tr> <tr> <td><b>Computer input/output port</b></td> <td>AUDIO IN3 (R, L) ..... RCA x2</td> </tr> <tr> <td>COMPUTER IN2/MONITOR OUT</td> <td>AUDIO OUT ..... Stereo mini x1</td> </tr> <tr> <td>..... D-sub 15 pin mini x1</td> <td><b>Others</b></td> </tr> <tr> <td><b>Video input port</b></td> <td>USB TYPE A .....USB-Ax2</td> </tr> <tr> <td>VIDEO ..... RCA x1</td> <td>USB TYPE B .....USB-Bx1</td> </tr> <tr> <td><b>HDMI input port</b></td> <td>CONTROL..... D-sub 9 pin x1</td> </tr> <tr> <td>HDMI 1 ..... HDMI connector x1</td> <td>LAN ..... RJ45 x1</td> </tr> <tr> <td>HDMI 2 / MHL</td> <td></td> </tr> <tr> <td>... HDMI/MHL connector x1</td> <td></td> </tr> </table>	<b>Computer input port</b>	<b>Audio input/output port</b>	COMPUTER IN1	AUDIO IN1 ..... Stereo mini x1	..... D-sub 15 pin mini x1	AUDIO IN2 ..... Stereo mini x1	<b>Computer input/output port</b>	AUDIO IN3 (R, L) ..... RCA x2	COMPUTER IN2/MONITOR OUT	AUDIO OUT ..... Stereo mini x1	..... D-sub 15 pin mini x1	<b>Others</b>	<b>Video input port</b>	USB TYPE A .....USB-Ax2	VIDEO ..... RCA x1	USB TYPE B .....USB-Bx1	<b>HDMI input port</b>	CONTROL..... D-sub 9 pin x1	HDMI 1 ..... HDMI connector x1	LAN ..... RJ45 x1	HDMI 2 / MHL		... HDMI/MHL connector x1	
<b>Computer input port</b>	<b>Audio input/output port</b>																								
COMPUTER IN1	AUDIO IN1 ..... Stereo mini x1																								
..... D-sub 15 pin mini x1	AUDIO IN2 ..... Stereo mini x1																								
<b>Computer input/output port</b>	AUDIO IN3 (R, L) ..... RCA x2																								
COMPUTER IN2/MONITOR OUT	AUDIO OUT ..... Stereo mini x1																								
..... D-sub 15 pin mini x1	<b>Others</b>																								
<b>Video input port</b>	USB TYPE A .....USB-Ax2																								
VIDEO ..... RCA x1	USB TYPE B .....USB-Bx1																								
<b>HDMI input port</b>	CONTROL..... D-sub 9 pin x1																								
HDMI 1 ..... HDMI connector x1	LAN ..... RJ45 x1																								
HDMI 2 / MHL																									
... HDMI/MHL connector x1																									
Optional parts	<b>Filter set:</b> UX43251 <b>Mounting accessory:</b> HAS-9110 (Bracket for ceiling mount) HAS-304H (Fixing adapter for high ceilings) HAS-WM06 (WALL MOUNT) <b>USB wireless adapter:</b> USB-WL-5G * For more information, please consult your dealer.																								

## Troubleshooting - Warranty and after-service

If an abnormal operation (such as smoke, strange odor or excessive sound) should occur, stop using the projector immediately.

Otherwise if a problem occurs with the projector, first refer to “Troubleshooting” of “Operating Guide” and “Network Guide”, and run through the suggested checks. If this does not resolve the problem, please consult your dealer or service company. They will tell you what warranty condition is applied.

Check our website where you may find the latest information for this product. (📖 1)

- NOTE** • The information in this manual is subject to change without notice.
- The illustrations in this manual are for illustrative purposes. They may differ slightly from your projector.
  - The manufacturer assumes no responsibility for any errors that may appear in this manual.
  - The reproduction, transfer or copy of all or any part of this document is not permitted without express written consent.

### Manufacturing year and month

The manufacturing year and month of this projector is indicated as follows in the serial number of the rating label on the projector.

Example:

**F 8 C x 0 0 0 0 1**

- └─ Manufacturing month: A = January, B = February, ... L = December.
- └─ Manufacturing year: 8 = 2018, 9 = 2019, 0 = 2020, ...

#### **DUKANE CORP AV SERVICE DEPT**

2900 Dukane Drive  
 St Charles, IL 60174  
 800-676-2487 / 630-762-4032  
 Fax 630-584-5156  
 avservice@dukane.com  
 www.dukaneav.com

**F-1**

- On a horizontal surface

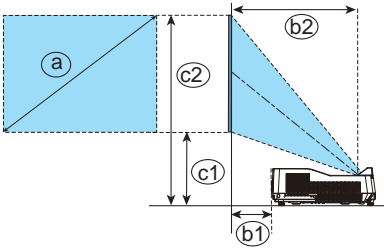

**F-2**

- Mounted on the wall or ceiling

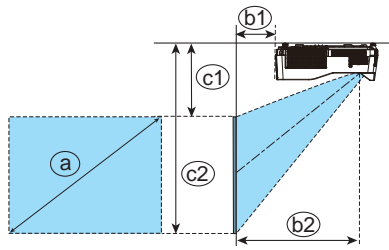

**T-1 TBD**

(1024 x 768) (±8%)

Screen size (diagonal) (a)		Projection distance				Screen height			
		(b1)		(b2)		(c1)		(c2)	
type(inch)	m	m	inch	m	inch	m	inch	m	inch
60	1.5	0.052	2.1	0.387	15.2	0.228	9.0	1.143	45.0
70	1.8	0.118	4.7	0.453	17.8	0.251	9.9	1.318	51.9
80	2.0	0.184	7.3	0.519	20.4	0.274	10.8	1.493	58.8
90	2.3	0.250	9.9	0.585	23.0	0.297	11.7	1.669	65.7
100	2.5	0.316	12.5	0.651	25.6	0.320	12.6	1.844	72.6
130	3.3	0.514	20.2	0.849	33.4	0.388	15.3	2.370	93.3

**T-2 8133WSS/8142WSS**

(1280 x 800) (±8%)

Screen size (diagonal) (a)		Projection distance				Screen height			
		(b1)		(b2)		(c1)		(c2)	
type(inch)	m	m	inch	m	inch	m	inch	m	inch
60	1.5	0.079	3.1	0.413	16.3	0.237	9.3	1.044	41.1
70	1.8	0.149	5.9	0.483	19.0	0.261	10.3	1.203	47.4
80	2.0	0.219	8.6	0.553	21.8	0.285	11.2	1.362	53.6
90	2.3	0.289	11.4	0.623	24.5	0.309	12.2	1.521	59.9
100	2.5	0.359	14.1	0.693	27.3	0.334	13.1	1.680	66.1
130	3.3	0.568	22.4	0.903	35.5	0.406	16.0	2.156	84.9

F-3

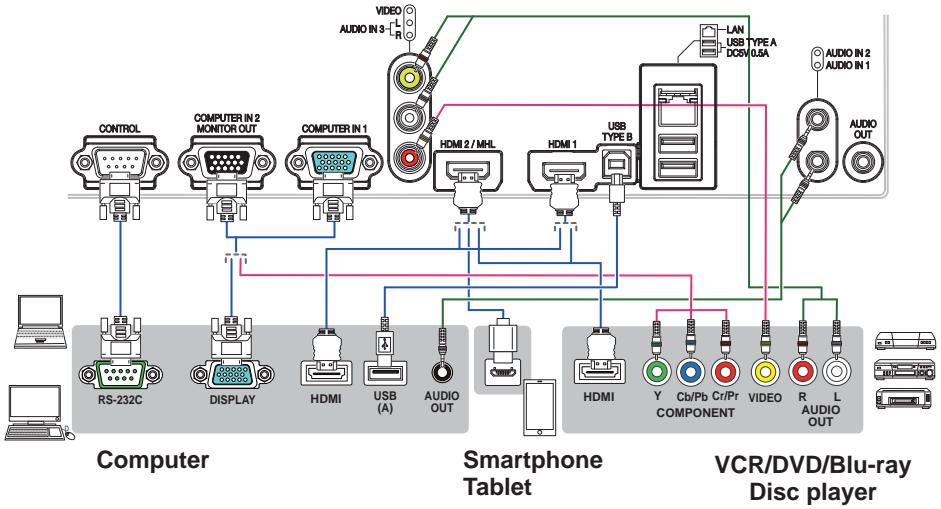

F-4

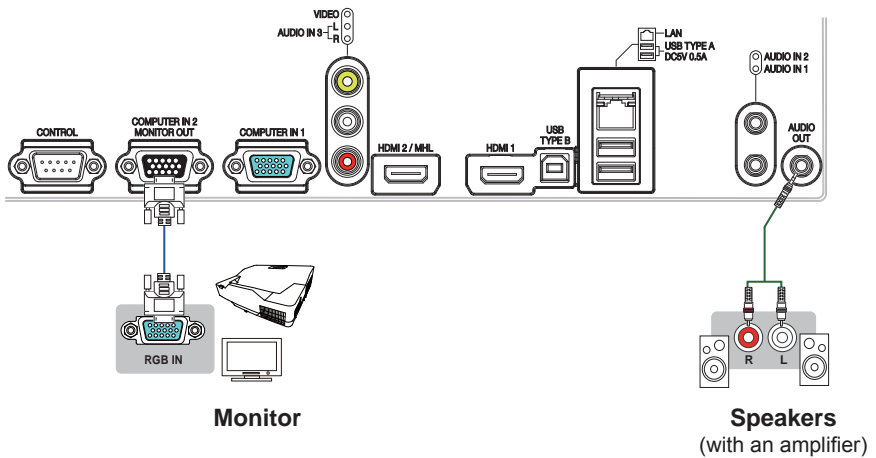

F-5

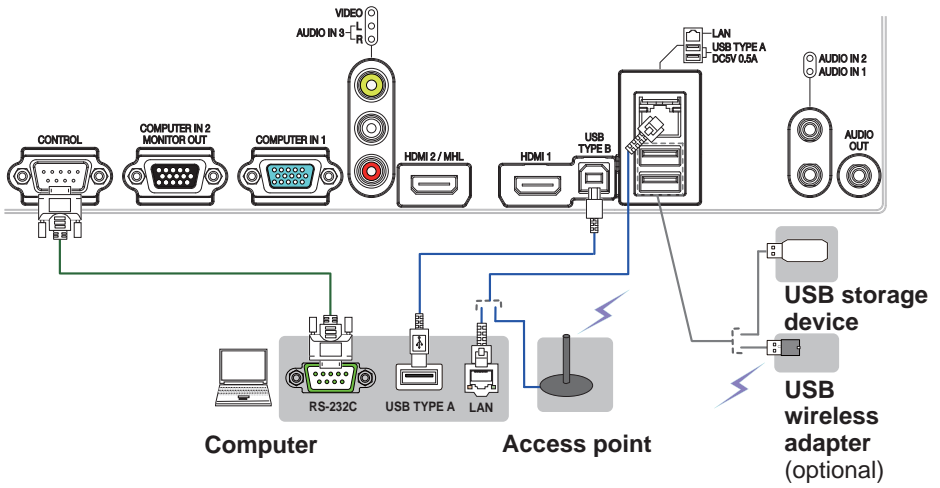

F-6

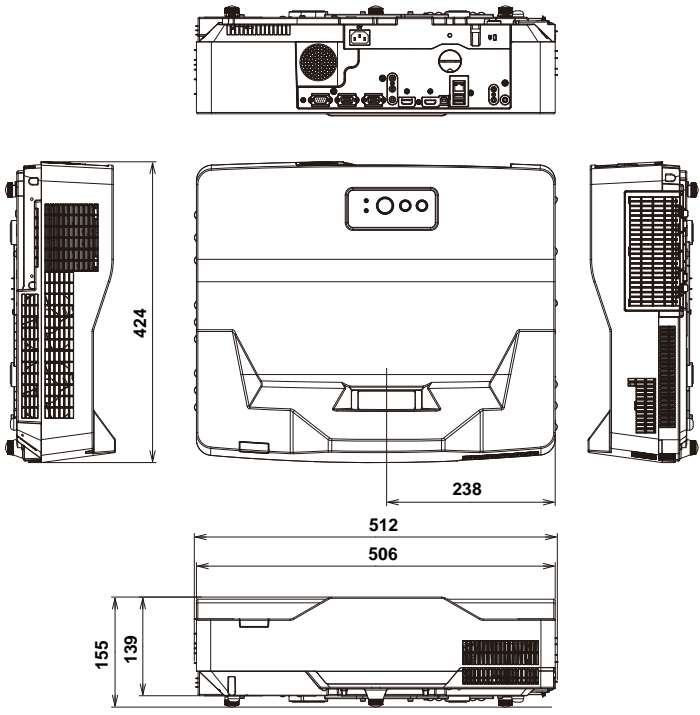

F-7

(1)

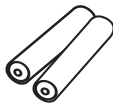
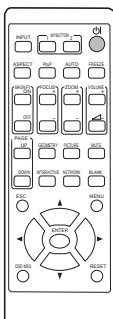

(2)

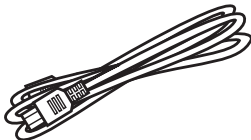

(3)

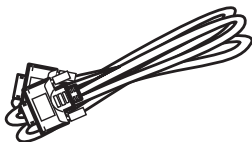

(4)

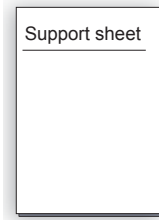

(5)

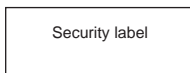

(6)



(7)

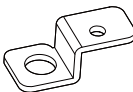

(8)



(9)

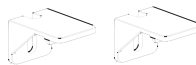

(10)



(11)

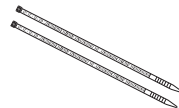

(12)



(13)

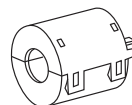

End User License Agreement for the Product Software  
Software in the product consists of the plural number of independent software modules and there exist our copyright and/or third party copyrights for each of such software modules. The product also uses software modules that we have developed and/or produced. And there exist our copyright and intellectual property for each of such software and related items including but not limited to the software related documents.

These rights above are protected by copyright law and other applicable laws. And the product uses software modules licensed as Freeware upon GNU GENERAL PUBLIC LICENSE Version 2 and GNU LESSER GENERAL PUBLIC LICENSE Version 2.1 established by Free Software Foundation, Inc. (U.S.) or license agreements for each software.

Refer to the following web page for license agreements for such software modules and other software.

**Our website:** <http://www.hitachiconsumer.com.sg>

Contact dealer in your region for inquiry regarding licensed software. Refer to license agreements of each software on the web page for detail of the license conditions and so on. (The original in English is carried since the license agreement is established by third party other than us.)

Because the program (the software module) is licensed free of charge, the program is provided "as is" without warranty of any kind, either expressed or implied, to the extent permitted by applicable law. And we do not take any responsibility or compensate for loss of any kind (including but not limited to loss of data, loss of accuracy or loss of compatibility with interface between other programs) by the software concerned and/or use of the software concerned to the extent permitted by applicable law.

#### Trademark acknowledgment

- HDMI, the HDMI logo and High-Definition Multimedia Interface are trademarks or registered trademarks of HDMI Licensing LLC in the United States and other countries.
  - MHL®, the MHL logo, and Mobile High-Definition Link are trademarks or registered trademarks of MHL, LLC in the United States and other countries.
  - Blu-ray Disc™ and Blu-ray™ are trademarks of Blu-ray Disc Association.
- All other trademarks are the properties of their respective owners.

**DUKANE CORP AV SERVICE DEPT**  
2900 Dukane Drive  
St Charles, IL 60174  
800-676-2487 / 630-762-  
Fax 630-584-5156  
[avservice@dukane.com](mailto:avservice@dukane.com)  
[www.dukaneav.com](http://www.dukaneav.com)