

# Data Video Projector User's Manual (Concise) MODELS: 8938W / 8939

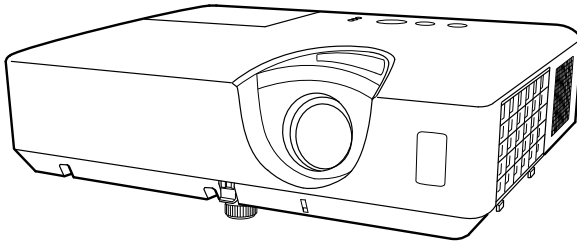

Information in this Guide may change due to product improvements. To obtain the latest manuals, literature, and software please visit the Dukane web site at; [www.dukane.com/av](http://www.dukane.com/av) and look at the specific model **SUPPORT** or **DOWNLOADS** section.

**DUKANE CORP AV SERVICE DEPT**  
2900 Dukane Drive  
St Charles, IL 60174  
800-676-2487 / 630-762-4032  
Fax 630-584-5156  
[avservice@dukane.com](mailto:avservice@dukane.com)  
[www.dukaneav.com](http://www.dukaneav.com)

430-8938W / 8939-Concise-00





Thank you for purchasing this projector.

Please read through this manual before using this product, in order to use safely and utilize well the product.

**⚠ WARNING** ▶ Before using this product, be sure to read all manuals for this product. After reading them, store them in a safe place for future reference.  
▶ Heed all the warnings and cautions in the manuals or on the product.  
▶ Follow all the instructions in the manuals or on the product.

**NOTE** • In this manual, unless any comments are accompanied, “the manuals” means all the documents provided with this product, and “the product” means this projector and all the accessories came with the projector.

## Contents

			
First of all.....	2	Connecting power supply .....	8
Entries and graphical symbols explanation .....	2	Turning on the power .....	9
Important safety instruction .....	2	Adjusting the projector's elevator .....	10
Regulatory notices.....	3	Displaying the picture .....	11
About Electro-Magnetic Interference .....	3	Turning off the power .....	12
About Waste Electrical and Electronic Equipment...4		Replacing the lamp.....	13
Contents of package.....	4	Cleaning and replacing the air filter ..	15
Preparing for the remote control.....	5	Using the CD manual .....	17
Arrangement.....	6	Specifications .....	18
Connecting with your devices.....	7	Troubleshooting	
Fastening the adapter cover.....	8	- Warranty and after-service .....	20

# First of all

## Entries and graphical symbols explanation

The following entries and graphical symbols are used for the manuals and the product as follows, for safety purpose. Please know their meanings beforehand, and heed them.

- ⚠WARNING** This entry warns of a risk of serious personal injury or even death.
- ⚠CAUTION** This entry warns of a risk of personal injury or physical damage.
- NOTICE** This entry notices of fear of causing trouble.

## Important safety instruction

The followings are important instructions for safely using the product. Be sure to follow them always when handling the product. The manufacturer assumes no responsibility for any damage caused by mishandling that is beyond normal usage defined in these manuals of this projector.

- ⚠WARNING** ► Never use the product in or after an abnormality (ex. giving off smoke, smelling strange, took a liquid or an object inside, broken, etc.) If an abnormality should occur, unplug the projector urgently.
  - Situate the product away from children and pets.
  - Keep small parts away from children and pets. If swallowed, consult a physician immediately for emergency treatment.
  - Do not use the product when there is fear of a thunderbolt.
  - Unplug the projector from the power outlet if the projector is not used for the time being.
  - Do not open or remove any portion of the product, unless the manuals direct it. For internal maintenance, leave it to your dealer or their service personnel.
  - Use only the accessories specified or recommended by the manufacturer.
  - Do not modify the projector or accessories.
  - Do not let any things or any liquids enter to the inside of the product.
  - Do not wet the product.
  - Do not place the projector where any oils, such as cooking or machine oil, are used. Oil may harm the product, resulting in malfunction, or falling from the mounted position.
  - Do not apply a shock or pressure to this product.
- Do not place the product on an unstable place such as the uneven surface or the leaned table.
- Do not place the product unstably. Place the projector so that it does not protrude from the surface where the projector is placed on.
- Remove all the attachments including the power cord and cables, from the projector when carrying the projector.
  - Do not look into the lens and the openings on the projector, while the lamp is on.
  - Do not approach the lamp cover and the exhaust vents, while the projection lamp is on. Also after the lamp goes out, do not approach them for a while, since too hot.

# Regulatory notices

## About Electro-Magnetic Interference

### In CANADA

This Class B digital apparatus complies with Canadian ICES-003.

### In the US, and other places where the FCC regulations are applicable

#### Declaration of Conformity

Trade name	HITACHI / DUKANE
Model Number	CP-X4030WN / 8939, CP-WX3530WN / 8938W
Responsible Party	Hitachi America, Ltd.
Address	2420 Fenton Street, Suite 200 Chula Vista, CA 91914 U.S.A.
Telephone Number	+1 -800-448-2244

This device complies with part 15 of the FCC Rules. Operation is subject to the following two conditions: (1) This device may not cause harmful interference, and (2) this device must accept any interference received, including interference that may cause undesired operation. This equipment has been tested and found to comply with the limits for a Class B digital device, pursuant to Part 15 of the FCC Rules.

These limits are designed to provide reasonable protection against harmful interference in a residential installation. This equipment generates, uses, and can radiate radio frequency energy and, if not installed and used in accordance with the instructions, may cause harmful interference to radio communications. However, there is no guarantee that interference will not occur in a particular installation. If this equipment does cause harmful interference to radio or television reception, which can be determined by turning the equipment off and on, the user is encouraged to try to correct the interference by one or more of the following measures:

- Reorient or relocate the receiving antenna.
- Increase the separation between the equipment and receiver.
- Connect the equipment into an outlet on a circuit different from that to which the receiver is connected.
- Consult the dealer or an experienced radio/TV technician for help.

**INSTRUCTIONS TO USERS:** This equipment complies with the requirements of FCC (Federal Communication Commission) equipment provided that the following conditions are met. Some cables have to be used with the core set. Use the accessory cable or a designated-type cable for the connection. For cables that have a core only at one end, connect the core to the projector.

**CAUTION:** Changes or modifications not expressly approved by the party responsible for compliance could void the user's authority to operate the equipment.

## Regulatory notices (continued)

### About Waste Electrical and Electronic Equipment



The mark is in compliance with the Waste Electrical and Electronic Equipment Directive 2002/96/EC (WEEE).

The mark indicates the requirement NOT to dispose the equipment including any spent or discarded batteries or accumulators as unsorted municipal waste, but use the return and collection systems available. If the batteries or accumulators included with this equipment, display the chemical symbol Hg, Cd, or Pb, then it means that the battery has a heavy metal content of more than 0.0005% Mercury or more than, 0.002% Cadmium, or more than 0.004% Lead.

### Contents of package

Your projector should come with the items shown below. Check that all the items are included. Require of your dealer immediately if any items are missing.

- (1) Remote control with two AA batteries
- (2) Power cord
- (3) Computer cable
- (4) User's manuals (Book x1, CD x1)

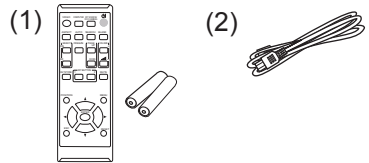

<CP-X4030WN/CP-WX3530WN only>

- (5) Security label
- (6) Lens cover
- (7) Adapter cover
- (8) Application CD

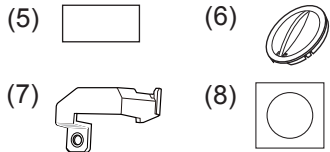

**⚠ WARNING** ► Keep small parts away from children and pets. Take care not to put in the mouth. If swallowed, consult a physician immediately for emergency treatment.

**NOTE** • Keep the original packing materials for future reshipment. Be sure to use the original packing materials when moving the projector. Use special caution for the lens.

• The projector may make a rattling sound when tilted, moved or shaken, since a flap to control the air flow inside of the projector has moved. Be aware that this is not a failure or malfunction.

## Preparing for the remote control

Please insert the batteries into the remote control before using it. If the remote control starts to malfunction, try to replace the batteries. If you will not use the remote control for long period, remove the batteries from the remote control and store them in a safe place.

1. Remove the battery cover.
2. Align and insert the two AA batteries (HITACHI MAXELL, Part No.LR6 or R6P) according to their plus and minus terminals as indicated in the remote control.
3. Put the battery cover back to the former state.

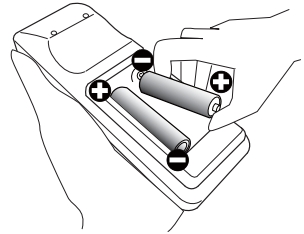

- ⚠ WARNING** ► Always handle the batteries with care and use them only as directed. Improper use may result in battery explosion, cracking or leakage, which could result in fire, injury and/or pollution of the surrounding environment.
- When replacing the batteries, replace both of the batteries with new batteries of the same type. Do not use a new battery with a used battery.
  - Be sure to use only the batteries specified. Do not use batteries of different types at the same time. Do not mix a new battery with used one.
  - Make sure the plus and minus terminals are correctly aligned when loading a battery.
  - Keep a battery away from children and pets.
  - Do not recharge, short circuit, solder or disassemble a battery.
  - Do not place a battery in a fire or water. Keep batteries in a dark, cool and dry place.
  - If you observe battery leakage, wipe out the leakage and then replace a battery. If the leakage adheres to your body or clothes, rinse well with water immediately.
  - Obey the local laws on disposing the battery.

# Arrangement

Refer to tables T-1 or T-2 and figures F-1 and F-2 at the end of this manual to determine the screen size and projection distance. The values shown in the table are calculated for a full size screen.

- Ⓐ Screen size (diagonal)
- Ⓑ Projection distance ( $\pm 10\%$ , from the projector's end)
- Ⓒ, Ⓓ Screen height ( $\pm 10\%$ )

• If the projector is used at an altitude of about 1600 m (5250 feet) or higher, set ALTITUDE of the SERVICE item in the OPTION menu to HIGH. Otherwise, set it to NORMAL. If the projector is used with a wrong setting, it may cause damage to the projector itself or the parts inside.

**⚠ WARNING** ▶ Install the projector where you can access the power outlet easily.

▶ Install the projector in a stable horizontal position.

- Do not use any mounting accessories except the accessories specified by the manufacturer. Read and keep the manuals of the accessories used.
- For special installation such as ceiling mounting, be sure to consult your dealer beforehand. Specific mounting accessories and services may be required.
- Do not put the projector on its side, front or rear position.
- Do not attach nor place anything on the projector unless otherwise specified in the manual.

▶ Do not install the projector near thermally conductive or flammable things.

▶ Do not place the projector where any oils, such as cooking or machine oil, are used.

▶ Do not place the projector in a place where it may get wet.

**⚠ CAUTION** ▶ Place the projector in a cool place with sufficient ventilation.

- Keep a space of 30 cm or more between a side of the projector and other objects such as walls.
- Do not stop up, block nor cover the projector's vent holes.
- Do not place the projector at places that are exposed to magnetic fields, doing so can cause the cooling fans inside the projector to malfunction.
- ▶ Avoid placing the projector in smoky, humid or dusty place.
- Do not place the projector near humidifiers.

**NOTICE** ▶ Position the projector to prevent light from directly hitting the projector's remote sensor.

▶ Do not place the product in a place where radio interference may be caused.

▶ Check and correct the setting for ALTITUDE of SERVICE in the OPTION menu according to the usage environment. For details, see **User's Manual - Operating Guide**.



## Connecting with your devices

Before connecting the projector to a device, consult the manual of the device to confirm that the device is suitable for connecting with this projector and prepare the required accessories, such as a cable in accord with the signal of the device. Consult your dealer when the required accessory did not come with the product or the accessory is damaged.

After making sure that the projector and the devices are turned off, perform the connection, according to the following instructions. Refer to figures **F-3** to **F-8** at the end of this manual. For details, see **User's Manual - Operating Guide**.

<8938W/8939 only> Before connecting the projector to a network system, be sure to read **User's Manual - Network Guide** too.

**⚠ WARNING** ▶ Use only the appropriate accessories. Otherwise it could cause a fire or damage the projector and devices.

- Use only the accessories specified or recommended by the projector's manufacturer. It may be regulated under some standard.
- Neither disassemble nor modify the projector and the accessories.
- Do not use the damaged accessory. Be careful not to damage the accessories. Route a cable so that it is neither stepped on nor pinched out.

**⚠ CAUTION** ▶ For a cable with a core at only one end, connect the end with the core to the projector. That may be required by EMI regulations.

<CP-X4030WN/CP-WX3530WN only>

▶ Before connecting the projector to a network system be sure to obtain the consent of the administrator of the network.

▶ Do not connect the **LAN** port to any network that might have the excessive voltage.

▶ The designated USB wireless adapter that is sold as an option is required to use the wireless network function of this projector.

▶ Before removing the USB storage device from the port of the projector, be sure to use the REMOVE USB function on the thumbnail screen to secure your data. Before you insert or pull out the USB wireless adapter from the projector, turn off the power of the projector and pull out the power cord's plug from the outlet. Do not touch the USB wireless adapter while the projector is receiving AC power.

**NOTE** • Do not turn on or off the projector while connected to a device in operation, unless that is directed in the manual of the device.

• Some input ports are selectable in the use. For details, see **User's Manual - Operating Guide**.

• Be careful not to mistakenly connect a connector to a wrong port.

• <8938W/8939 only> If an oversized USB storage device blocks the **LAN** port, use a USB extension cable to connect the USB storage device.

## Fastening the adapter cover

<8938W/8939 only>

Use the supplied adapter cover to prevent the USB wireless adapter (optional) from coming off easily and prevention from burn injury.

1. Loosen the screw (marked with triangle) on the bottom left of the **USB TYPE A** port.
2. Insert the tab of the cover into the hole at the upper right of the **USB TYPE A** port in the direction of the arrow.
3. Align the screw holes on the projector and the cover. Then insert the screw removed from the projector into the hole and tighten the screw.

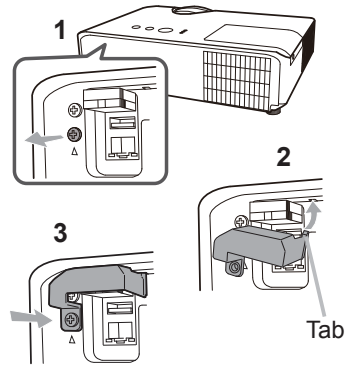

**⚠WARNING** ► Keep small parts away from children and pets. Take care not to put in the mouth. Heat may build up in the USB wireless adapter, to avoid possible burns disconnect the projector power cord for more than 5min. before touching it.

## Connecting power supply

1. Put the connector of the power cord into the **AC** (AC inlet) of the projector.
2. Firmly plug the power cord's plug into the outlet. In a couple of seconds after the power supply connection, the **POWER** indicator will light up in steady orange.

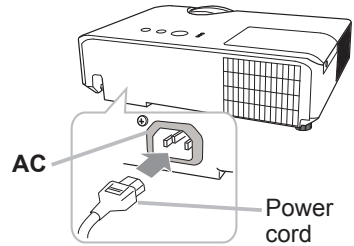

Please remember that when the **DIRECT POWER ON** function activated, the connection of the power supply make the projector turn on.

**⚠WARNING** ► Please use extra caution when connecting the power cord, as incorrect or faulty connections may result in fire and/or electrical shock.

- Do not touch the power cord with a wet hand.
- Only use the power cord that came with the projector. If it is damaged, consult your dealer to get a new one. Never modify the power cord.
- Only plug the power cord into an outlet whose voltage is matched to the power cord. The power outlet should be close to the projector and easily accessible. Remove the power cord for complete separation.
- Do not distribute the power supply to multiple devices. Doing so may overload the outlet and connectors, loosen the connection, or result in fire, electric shock or other accidents.
- Connect the ground terminal for the AC inlet of this unit to the ground terminal of the building using an appropriate power cord (bundled).

**NOTICE** ► This product is also designed for IT power systems with a phase-to-phase voltage of 220 to 240 V.

## Turning on the power

1. Make sure that the power cord is firmly and correctly connected to the projector and the outlet.
2. Make sure that the **POWER** indicator is steady orange.  
<8938W/8939 only>

Then remove the lens cover.

3. Press the **STANDBY/ON** button on the projector or the remote control.

The projection lamp will light up and the **POWER** indicator will begin blinking in green. When the power is completely on, the indicator will stop blinking and light in steady green.

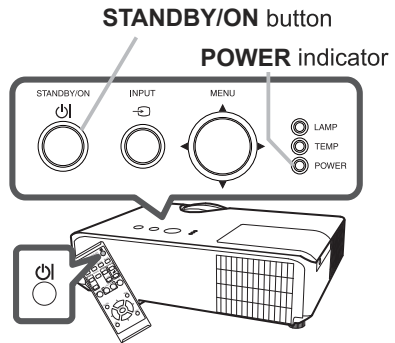

**⚠ WARNING** ► A strong light is emitted when the projector's power is on. Do not look into the lens of the projector or look inside of the projector through any of the projector's openings.

**NOTE** • Please power on the projector prior to the connected devices.  
• The projector has the DIRECT POWER ON function, which can make the projector automatically turn on. For more information, please see **User's Manual - Operating Guide**.

**Note:** The Dukane models described in this document are manufactured by Hitachi and use the same firmware, software programs, control code, and accessory parts. The equivalent Dukane to Hitachi models are; 8938W (CP-WX3530WN), and 8939 (CP-X4030WN).

## Adjusting the projector's elevator

### <Front Foot>

Using the Front elevator foot can tilt the projector in order to project at a suitable angle to the screen, elevating the front side of the projector within 12 degrees. The elevator foot is adjustable while pushing the elevator button.

1. Holding the projector, push the elevator button to loose the elevator foot.
2. Release the elevator button in order to lock the elevator foot.
3. If necessary, the elevator foot can be manually twisted to make more precise adjustments. Hold the projector when twisting the foot.

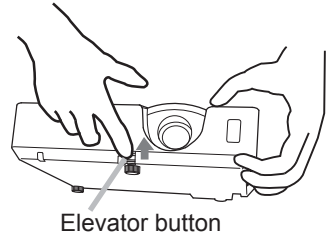

**⚠ CAUTION** ▶ Do not handle the elevator button without holding the projector, since the projector may drop down.

▶ Do not tilt the projector other than elevating its front within 12 degrees using the elevator foot. A tilt of the projector exceeding the restriction could cause malfunction or shortening the lifetime of consumables, or the projector itself.

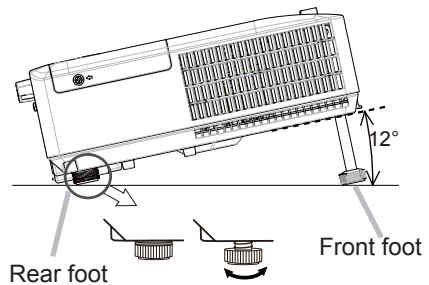

### <Rear Foot>

When the place to put the projector is slightly uneven to the left or right, use the Rear elevator foot to place the projector horizontally. A spacer is installed on the Rear elevator foot at the time of shipment, and the projector is ready for use. If necessary, detach the spacer, and the elevator foot can be manually twisted to make more precise adjustments.

**⚠ WARNING** ▶ Keep the spacer away from children and pets. Be careful not to let them swallow the spacer. If swallowed consult a physician immediately for emergency treatment.

**NOTE** • After the foot is adjusted, it is possible to return it to the state of the shipment with a spacer. It is recommended to keep the spacer and reuse it when relocating the projector.

## Displaying the picture

1. Activate your signal source. Turn the signal source on, and make it send the signal to the projector.
2. Press the **INPUT** button on the projector. Each time you press the button, the projector switches its input port in turn. You can also use the remote control to select an input signal.

<8938W/8939 only>

Press the **VIDEO** button for selecting an input signal from the **HDMI**, **S-VIDEO** or **VIDEO** port, or the **COMPUTER** button for selecting an input signal from the **COMPUTER IN1**, **COMPUTER IN2**, **LAN**, **USB TYPE A** or **USB TYPE B** port.

<Future Model only>

Press the **VIDEO** button for selecting an input signal from the **HDMI** or **VIDEO** port, or the **COMPUTER** button for selecting an input signal from the **COMPUTER IN1** or **COMPUTER IN2** port.

3. Use the **VOLUME + / VOLUME -** buttons to adjust the volume. To have the projector silent, press the **MUTE** button on the remote control.
4. Press the **ASPECT** button on the remote control. Each time you press the button, the projector switches the mode for aspect ratio in turn.
5. Use the **ZOOM** ring to adjust the screen size.
6. Use the **FOCUS** ring to focus the picture.

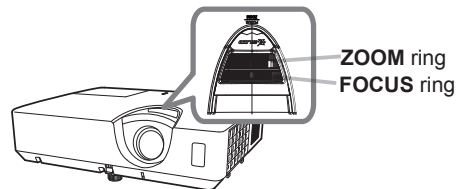
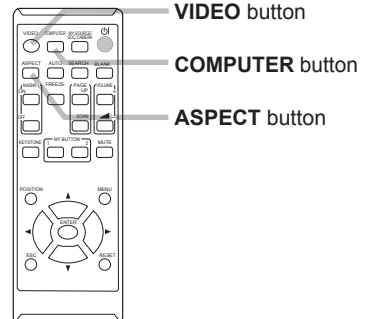
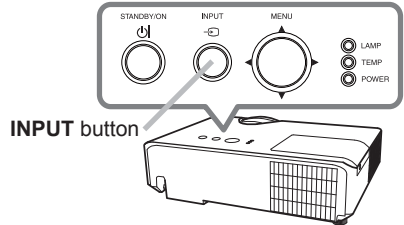
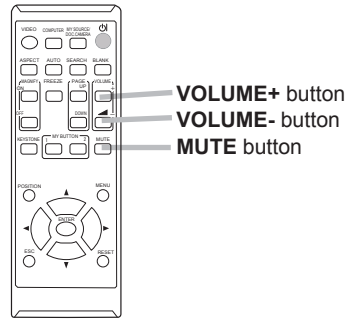

**⚠ CAUTION** ► If you wish to have a blank screen while the projector's lamp is on, use the **BLANK** function. (see **User's Manual - Operating Guide**) Taking any other action may cause the damage on the projector.

(continued on next page)

## Displaying the picture (continued)

**NOTE** • The **ASPECT** button does not work when no proper signal is inputted.

- For the details of how to adjust the picture, please see **User's Manual - Operating Guide**.
- There may be some noise and/or the screen may flicker for a moment when an operation is made. This is not a malfunction.

## Turning off the power

1. Press the **STANDBY/ON** button on the projector or the remote control.  
The message "Power off?" will appear on the screen for about 5 seconds.
2. Press the **STANDBY/ON** button again while the message appears.  
The projector lamp will go off, and the **POWER** indicator will begin blinking in orange. Then the **POWER** indicator will stop blinking and light in steady orange when the lamp cooling is complete.
3. <CP-X4030WN/CP-WX3530WN only>  
Attach the lens cover, after the **POWER** indicator turns in steady orange.

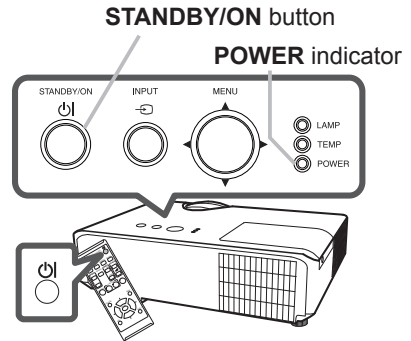

Do not turn the projector on for about 10 minutes or more after turning it off. Also, do not turn the projector off shortly after turning it on. Such operations might cause the lamp to malfunction or shorten the lifetime of some parts including the lamp.

**⚠ WARNING** ► Do not touch around the lamp cover and the exhaust vents during use or just after use, since it is too hot.

► Remove the power cord for complete separation. The power outlet should be close to the projector and easily accessible.

**NOTE** • Please power off the projector after any connected devices are powered off.

- This projector has the **AUTO POWER OFF** function that can make the projector turn off automatically. For more information, please see **User's Manual - Operating Guide**.

## Replacing the lamp

A lamp has finite product life. Using the lamp for long periods of time could cause the pictures darker or the color tone poor. Note that each lamp has a different lifetime, and some may burst or burn out soon after you start using them. Preparation of a new lamp and early replacement are recommended. To prepare a new lamp, make contact with your dealer and tell the lamp type number.

**Type number : 8938W/8939: 456-8931WA,**

1. Turn the projector off, and unplug the power cord. Allow the projector to cool for at least 45 minutes.
2. Prepare a new lamp. If the projector is mounted on a ceiling, or if the lamp has broken, also ask the dealer to replace the lamp.  
In case of replacement by yourself, follow the following procedure.

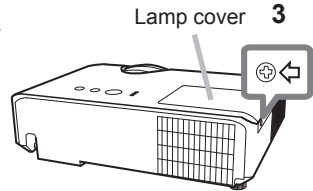

3. Loosen the screw (marked by arrow) of the lamp cover and then slide and lift the lamp cover to the side to remove it.
4. Loosen the 2 screws (marked by arrow) of the lamp, and slowly pick up the lamp by the handle.  
**Never loosen any other screws.**

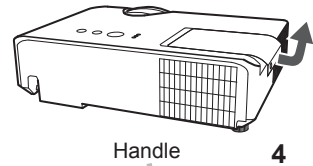

5. Insert the new lamp, and retighten firmly the 2 screws of the lamp that are loosened in the previous process to lock it in place.
6. While putting the interlocking parts of the lamp cover and the projector together, slide the lamp cover back in place. Then firmly fasten the screw of the lamp cover.
7. Turn the projector on and reset the lamp time using the LAMP TIME item in the OPTION menu.

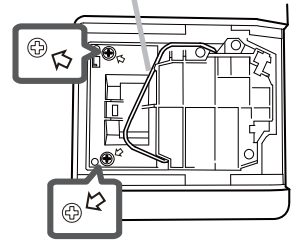

- (1) Press the **MENU** button to display a menu.
- (2) Point at the **ADVANCED MENU** in the menu using the **▼/▲** button, then press the **▶** button.
- (3) Point at the **OPTION** in the left column of the menu using the **▼/▲** button, then press the **▶** button.
- (4) Point at the **LAMP TIME** using the **▼/▲** button, then press the **▶** button. A dialog will appear.
- (5) Press the **▶** button to select "OK" on the dialog. It performs resetting the lamp time.

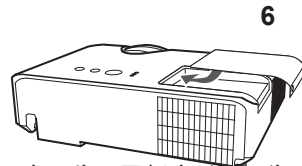

**⚠ CAUTION ▶** Do not touch any inner space of the projector, while the lamp is taken out.

**NOTE** • Please reset the lamp time only when you have replaced the lamp, for a suitable indication about the lamp.

## Replacing the lamp (continued)

 **HIGH VOLTAGE**    **HIGH TEMPERATURE**    **HIGH PRESSURE**

**⚠ WARNING** ► The projector uses a high-pressure mercury glass lamp. The lamp can break with a loud bang, or burn out, if jolted or scratched, handled while hot, or worn over time. Note that each lamp has a different lifetime, and some may burst or burn out soon after you start using them. In addition, if the bulb bursts, it is possible for shards of glass to fly into the lamp housing, and for gas containing mercury and dust containing fine particles of glass to escape from the projector's vent holes.

► **About disposal of a lamp:** This product contains a mercury lamp; do not put it in a trash. Dispose of it in accordance with environmental laws.

- For lamp recycling, go to [www.lamprecycle.org](http://www.lamprecycle.org) (in the US).
- For product disposal, consult your local government agency or [www.eiae.org](http://www.eiae.org) (in the US) or [www.epsc.ca](http://www.epsc.ca) (in Canada).

For more information, ask your dealer.



Disconnect  
the plug  
from the  
power  
outlet

- If the lamp should break (it will make a loud bang when it does), unplug the power cord from the outlet, and make sure to request a replacement lamp from your local dealer. Note that shards of glass could damage the projector's internals, or cause injury during handling, so please do not try to clean the projector or replace the lamp yourself.
- If the lamp should break (it will make a loud bang when it does), ventilate the room well, and make sure not to inhale the gas or fine particles that come out from the projector's vent holes, and not to get them into your eyes or mouth.
- Before replacing the lamp, turn the projector off and unplug the power cord, then wait at least 45 minutes for the lamp to cool sufficiently. Handling the lamp while hot can cause burns, as well as damaging the lamp.



- Never unscrew except the appointed (marked by an arrow) screws.
- Do not open the lamp cover while the projector is suspended from a ceiling. This is dangerous, since if the lamp's bulb has broken, the shards will fall out when the cover is opened. In addition, working in high places is dangerous, so ask your local dealer to have the lamp replaced even if the bulb is not broken.
- Do not use the projector with the lamp cover removed. At the lamp replacing, make sure that the screws are screwed in firmly. Loose screws could result in damage or injury.



- Use only the lamp of the specified type. Use of a lamp that does not meet the lamp specifications for this model could cause a fire, damage or shorten the life of this product.
- If the lamp breaks soon after the first time it is used, it is possible that there are electrical problems elsewhere besides the lamp. If this happens, consult your local dealer or a service representative.
- Handle with care: jolting or scratching could cause the lamp bulb to burst during use.
- Using the lamp for long periods of time, could cause it dark, not to light up or to burst. When the pictures appear dark, or when the color tone is poor, please replace the lamp as soon as possible. Do not use old (used) lamps; this is a cause of breakage.



## Cleaning and replacing the air filter

<8938W/8939>

Please check and clean the air filter periodically. When the indicators or a message prompts you to clean the air filter, comply with it as soon as possible. Replace the filter when it is damaged or too soiled. To prepare the new filter, make contact with your dealer and tell the following type number.

**Type number : UX38841** (Filter set)

When you replace the lamp, please replace the air filter. An air filter of specified type will come together with a replacement lamp for this projector.

1. Turn the projector off, and unplug the power cord. Allow the projector to sufficiently cool down.
2. Use a vacuum cleaner on and around the filter cover.
3. Pick and pull up the filter cover knobs to take it off.
4. Use a vacuum cleaner for the filter vent of the projector.
5. Take the filter out while holding the filter cover.
6. Use a vacuum cleaner on both sides of the filter. If the filter is damaged or heavily soiled, replace it with the new one.
7. Place the filter back into the filter cover, making sure the plastic band is on the upper side.
8. Install the filter unit back into the projector.
9. Turn the projector on and reset the filter time using the FILTER TIME item in the EASY MENU.
  - (1) Press the **MENU** button to display a menu.
  - (2) Point at the FILTER TIME using the ▼/▲ button, then press the ► button. A dialog will appear.
  - (3) Press the ► button to select "OK" on the dialog. It performs resetting the filter time.

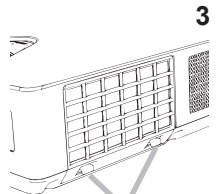
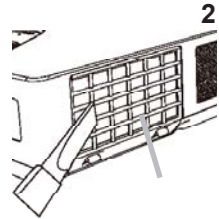

Filter cover knobs

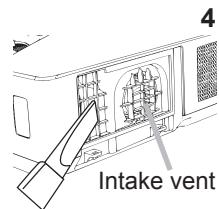

Intake vent

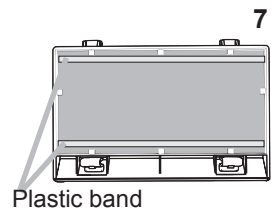

Plastic band

- ▲WARNING** ► Before taking care of the air filter, make sure the power cable is not plugged in, then allow the projector to cool sufficiently.
- Use only the air filter of the specified type. Do not use the projector without the air filter or the filter cover. It could result in a fire or malfunction to the projector.
- Clean the air filter periodically. If the air filter becomes clogged by dust or the like, internal temperatures rise and could cause a fire, a burn or malfunction to the projector.

**NOTE** • Please reset the filter time only when you have cleaned or replaced the air filter, for a suitable indication about the air filter.

• The projector may display the message such as "CHECK THE AIR FLOW" or turn off the projector, to prevent the internal heat level rising.

## Cleaning and replacing the air filter (continued)

<Future Model>

Please check and clean the air filter periodically. When the indicators or a message prompts you to clean the air filter, comply with it as soon as possible. The air filter has two kinds of filters inside. Replace the filters when they are damaged or too soiled. To prepare the new filters, make contact with your dealer and tell the following type number.

**Type number : UX38851** (Filter set)

When you replace the lamp, please replace the air filter. An air filter of specified type will come together with a replacement lamp for this projector.

1. Turn the projector off, and unplug the power cord. Allow the projector to sufficiently cool down.
2. Use a vacuum cleaner on and around the filter cover.
3. Pick and pull up the filter cover knobs to take it off.
4. Use a vacuum cleaner for the filter vent of the projector.
5. Take the fine filter out while holding the filter cover. It is recommended to leave the coarse filter in the filter cover as it is.
6. Use a vacuum cleaner on both sides of the fine filter while holding it so it will not be sucked in. Use a vacuum cleaner for the inside of the filter cover to clean up the coarse filter. If the filters are damaged or heavily soiled, replace them with new ones.
7. Place the fine filter on the coarse one.
8. Install the filter unit back into the projector.
9. Turn the projector on and reset the filter time using the FILTER TIME item in the EASY MENU.
  - (1) Press the **MENU** button to display a menu.
  - (2) Point at the FILTER TIME using the **▼/▲** button, then press the **▶** button. A dialog will appear.
  - (3) Press the **▶** button to select "OK" on the dialog. It performs resetting the filter time.

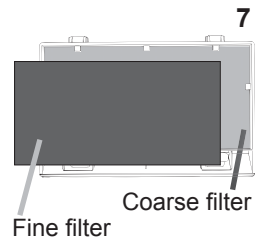
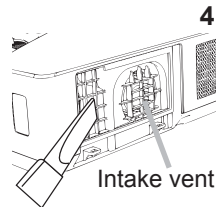
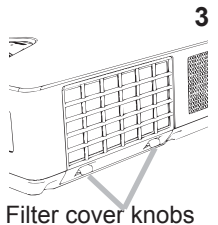
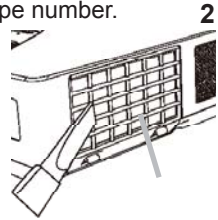

**⚠ WARNING ▶** Before taking care of the air filter, make sure the power cable is not plugged in, then allow the projector to cool sufficiently.  
▶ Use only the air filter of the specified type. Do not use the projector without the air filter or the filter cover. It could result in a fire or malfunction to the projector.  
▶ Clean the air filter periodically. If the air filter becomes clogged by dust or the like, internal temperatures rise and could cause a fire, a burn or malfunction to the projector.

**NOTE** • Please reset the filter time only when you have cleaned or replaced the air filter, for a suitable indication about the air filter.  
• The projector may display the message such as "CHECK THE AIR FLOW" or turn off the projector, to prevent the internal heat level rising.

## Using the CD manual

The other manuals for this product are written into the included CD-ROM titled "User's Manual (detailed)". Before using the CD-ROM, please read the following to ensure the proper use.

### ■ System requirements

The system for using the CD-ROM requires the following.

**Windows®:** OS:Microsoft®  
Windows® XP, Windows Vista®, Windows®7 or later

**Macintosh®:** OS:Mac OS® 10.2 or later

**CD-ROM/DVD-ROM drive:**

**Applications:** Microsoft® Internet Explorer®6.0 or later  
Adobe® Acrobat® Reader® 8.0 or later

### ■ How to use the CD

1. Insert CD into computer's CD-ROM/DVD-ROM drive.

**Windows®:** In a while, Web browser automatically starts. Start up window comes up.

**Macintosh®:** (1) Double-click on the "PROJECTORS" icon appeared on the desktop screen.  
(2) When "main.html" file is clicked, Web browser will start and Initial window will appear.

2. Click the model name of your projector first, and then click language you want from the displayed list. The User's manual (detailed) will open.

**⚠ CAUTION** ▶ Only use the CD-ROM in a computer CD/DVD drive. The CD-ROM is designed for computer use only. NEVER INSERT THE CD-ROM INTO A NON-COMPUTER CD/DVD PLAYER! Inserting the CD-ROM into an incompatible CD/DVD drive may produce a loud noise, which in turn MAY RESULT IN EAR AND SPEAKER DAMAGE!

- After using CD-ROM, please put it into CD case and keep it. Please keep the CD neither in direct sunlight nor in a high temperature and high humidity environment.

**NOTE** • The information in the CD-ROM is subject to change without notice. Please check our website where you may find the latest information for this projector. (📖20)

- No responsibility is taken for any obstacle and defect to hardware and software of your computer as a result of the use of the CD-ROM.
- All or Any part of the information in the CD-ROM must not be copied, reproduced or republished without notice to our company.

# Specifications

<8938W/8939>

Item	Specification
Product name	Liquid crystal projector
Liquid Crystal Panel	8939 : 786,432 pixels (1024 horizontal x 768 vertical) 8938W : 1,024,000 pixels (1280 horizontal x 800 vertical)
Lamp	225W UHP
Speaker	16 W mono
Power supply/ Rated current	AC 100-120 V: 3.4 A, AC 220-240 V: 1.7 A
Power consumption	AC 100-120 V: 330 W, AC 220-240 V: 310 W
Temperature range	5 ~ 35 °C (Operating at an altitude up to 7500 ft.(2286 m)) 5 ~ 30 °C (Operating at an altitude over 7500 ft.(2286 m))
Size	320 (W) x 85 (H) x 245 (D) mm * Not including protruding parts. Refer to figure <b>F-9</b> at the back of this manual.
Weight (mass)	approx. 3.0 kg
Ports	<b>COMPUTER IN1</b> ..... D-sub 15 pin mini jack x1 <b>COMPUTER IN2</b> ..... D-sub 15 pin mini jack x1 <b>HDMI</b> ..... HDMI connector x1 <b>MONITOR OUT</b> ..... D-sub 15 pin mini jack x1 <b>S-VIDEO</b> ..... Mini DIN 4 pin jack x1 <b>VIDEO</b> ..... RCA jack x1 <b>AUDIO IN1</b> ..... 3.5 mm (stereo) mini jack x1 <b>AUDIO IN2</b> ..... 3.5 mm (stereo) mini jack x1 <b>AUDIO IN3 (R, L)</b> ..... RCA jack x2 <b>AUDIO OUT (R, L)</b> ..... RCA jack x2 <b>USB TYPE A</b> ..... USB type A connector x2 <b>USB TYPE B</b> ..... USB type B connector x1 <b>CONTROL</b> ..... D-sub 9 pin plug x1 <b>LAN</b> ..... RJ45 jack x1 <b>MIC</b> ..... 3.5 mm (mono) mini jack x1
Optional parts	<b>Lamp:</b> 456-8931WA <b>Filter set:</b> UX38841

## Specifications (continued)

<Future Model>

Item	Specification
Product name	Liquid crystal projector
Liquid Crystal Panel	786,432 pixels (1024 horizontal x 768 vertical)
Lamp	225W UHP
Speaker	1 W mono
Power supply/ Rated current	AC 100-120 V: 3.3 A, AC 220-240 V: 1.6 A
Power consumption	AC 100-120 V: 320 W, AC 220-240 V: 300 W
Temperature range	5 ~ 35 °C (Operating)
Size	320 (W) x 85 (H) x 245 (D) mm * Not including protruding parts. Refer to figure <b>F-9</b> at the back of this manual.
Weight (mass)	approx. 2.9 kg
Ports	<b>COMPUTER IN1</b> ..... D-sub 15 pin mini jack x1 <b>COMPUTER IN2 / MONITOR OUT</b> ..... D-sub 15 pin mini jack x1 <b>HDMI</b> ..... HDMI connector x1 <b>VIDEO</b> ..... RCA jack x1 <b>AUDIO IN (R, L)</b> ..... RCA jack x2 <b>AUDIO OUT (R, L)</b> ..... RCA jack x2 <b>CONTROL</b> ..... D-sub 9 pin plug x1
Optional parts	<b>Lamp:</b> DT01491 <b>Filter set:</b> UX38851 <b>Mounting accessory:</b> HAS-EX300 (Bracket for ceiling mount) HAS-204L (Fixing adaptor for low ceilings) HAS-304H (Fixing adaptor for high ceilings) * For more information, please consult your dealer.

## Troubleshooting - Warranty and after-service

If an abnormal operation (such as smoke, strange odor or excessive sound) should occur, stop using the projector immediately.

Otherwise if a problem occurs with the projector, first refer to “Troubleshooting” of **User’s Manual - Operating Guide** and **Network Guide**, and run through the suggested checks.

If this does not resolve the problem, please consult your dealer or service company. They will tell you what warranty condition is applied.

Please check the following web address where you may find the latest information for this projector.

### DUKANE CORP AV SERVICE DEPT

2900 Dukane Drive  
St Charles, IL 60174  
800-676-2487 / 630-762-4032  
Fax 630-584-5156  
avservice@dukane.com  
www.dukaneav.com

**NOTE** • The information in this manual is subject to change without notice.

- The illustrations in this manual are for illustrative purposes. They may differ slightly from your projector.
- The manufacturer assumes no responsibility for any errors that may appear in this manual.
- The reproduction, transfer or copy of all or any part of this document is not permitted without express written consent.

### Trademark acknowledgment

- Mac®, Macintosh® and Mac OS® are registered trademarks of Apple Inc.
  - Adobe® and Acrobat®, Reader® are registered trademarks of Adobe Systems Incorporated.
  - Microsoft®, Internet Explorer®, Windows®, Windows Vista® and Windows® 7 are registered trademarks of Microsoft Corporation in the U.S. and/or other countries.
  - HDMI, the HDMI logo and High-Definition Multimedia Interface are trademarks or registered trademarks of HDMI Licensing LLC in the United States and other countries.
  - Blu-ray Disc™ and Blu-ray™ are trademarks of Blu-ray Disc Association.
- All other trademarks are the properties of their respective owners.

### End User License Agreement for the Projector Software

- Software in the projector consists of the plural number of independent software modules and there exist our copyright or/and third party copyrights for each of such software modules.
- Be sure to read “End User License Agreement for the Projector Software” which is separated document. (in the CD)

**T-1 8938W/Future Model**

(1024 x 768) (±10%)

a Screen size (diagonal)		4 : 3 screen								16 : 9 screen							
		b Projection distance				c1 Screen height		c2 Screen height		b Projection distance				c1 Screen height		c2 Screen height	
		min.		max.						min.		max.					
type (inch)	m	m	inch	m	inch	cm	inch	cm	inch	m	inch	m	inch	cm	inch	cm	inch
30	0.8	0.9	34	1.0	41	39	15	7	3	0.9	37	1.1	45	36	14	1	0
40	1.0	1.2	46	1.4	55	52	21	9	3	1.3	50	1.5	61	49	19	1	0
50	1.3	1.5	58	1.8	70	65	26	11	4	1.6	63	1.9	76	61	24	1	1
60	1.5	1.8	70	2.1	84	78	31	13	5	1.9	76	2.3	92	73	29	2	1
70	1.8	2.1	82	2.5	99	91	36	15	6	2.3	89	2.7	108	85	34	2	1
80	2.0	2.4	94	2.9	113	105	41	17	7	2.6	102	3.1	123	97	38	2	1
90	2.3	2.7	106	3.2	127	118	46	20	8	2.9	115	3.5	139	109	43	3	1
100	2.5	3.0	118	3.6	142	131	51	22	9	3.3	128	3.9	155	122	48	3	1
120	3.0	3.6	142	4.3	170	157	62	26	10	3.9	154	4.7	186	146	57	4	1
150	3.8	4.5	177	5.4	214	196	77	33	13	4.9	194	5.9	233	182	72	4	2
200	5.1	6.0	237	7.3	286	261	103	44	17	6.6	259	7.9	311	243	96	6	2
250	6.4	7.5	297	9.1	357	327	129	54	21	8.2	324	9.9	390	304	120	7	3
300	7.6	9.1	357	10.9	429	392	154	65	26	9.9	389	11.9	468	365	144	9	4

ENGLISH

**T-2 8939**

(1280 x 800) (±10%)

a Screen size (diagonal)		16 : 10 screen								4 : 3 screen							
		b Projection distance				c1 Screen height		c2 Screen height		b Projection distance				c1 Screen height		c2 Screen height	
		min.		max.						min.		max.					
type (inch)	m	m	inch	m	inch	cm	inch	cm	inch	m	inch	m	inch	cm	inch	cm	inch
30	0.8	0.9	36	1.1	44	38	15	3	1	1.0	41	1.3	50	42	17	3	1
40	1.0	1.2	49	1.5	59	50	20	4	2	1.4	55	1.7	67	57	22	4	2
50	1.3	1.6	61	1.9	74	63	25	5	2	1.8	70	2.1	84	71	28	5	2
60	1.5	1.9	74	2.3	89	75	30	6	2	2.1	84	2.6	101	85	33	7	3
70	1.8	2.2	87	2.7	105	88	34	7	3	2.5	98	3.0	119	99	39	8	3
80	2.0	2.5	99	3.0	120	100	39	8	3	2.9	113	3.5	136	113	45	9	3
90	2.3	2.8	112	3.4	135	113	44	9	3	3.2	127	3.9	153	127	50	10	4
100	2.5	3.2	125	3.8	150	125	49	10	4	3.6	142	4.3	170	142	56	11	4
120	3.0	3.8	150	4.6	181	150	59	12	5	4.3	170	5.2	205	170	67	13	5
150	3.8	4.8	188	5.8	227	188	74	14	6	5.4	213	6.5	257	212	84	16	6
200	5.1	6.4	252	7.7	303	250	98	19	8	7.2	285	8.7	343	283	111	22	9
250	6.4	8.0	315	9.6	379	313	123	24	9	9.1	357	10.9	429	354	139	27	11
300	7.6	9.6	379	11.6	455	375	148	29	11	10.9	429	13.1	516	425	167	33	13

**F-1**

• On a horizontal surface

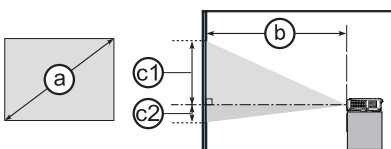

**F-2**

• Suspended from the ceiling

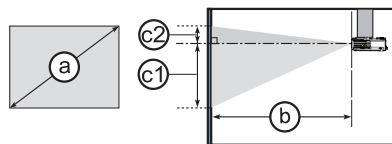

Computer

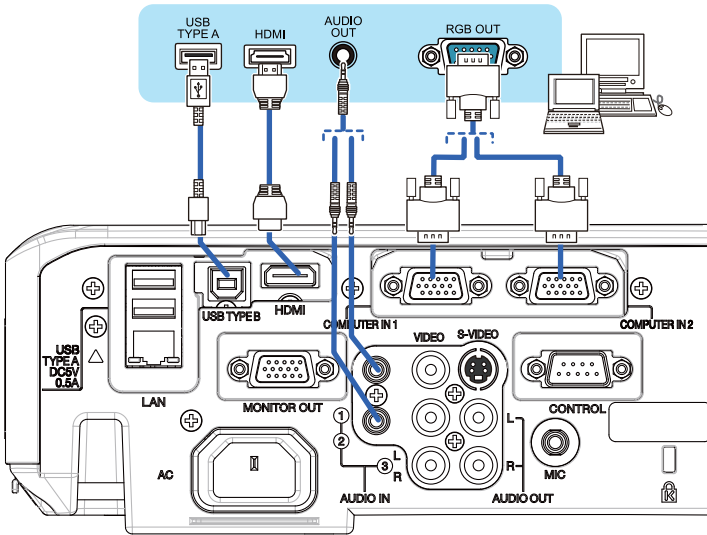

Computer

External device

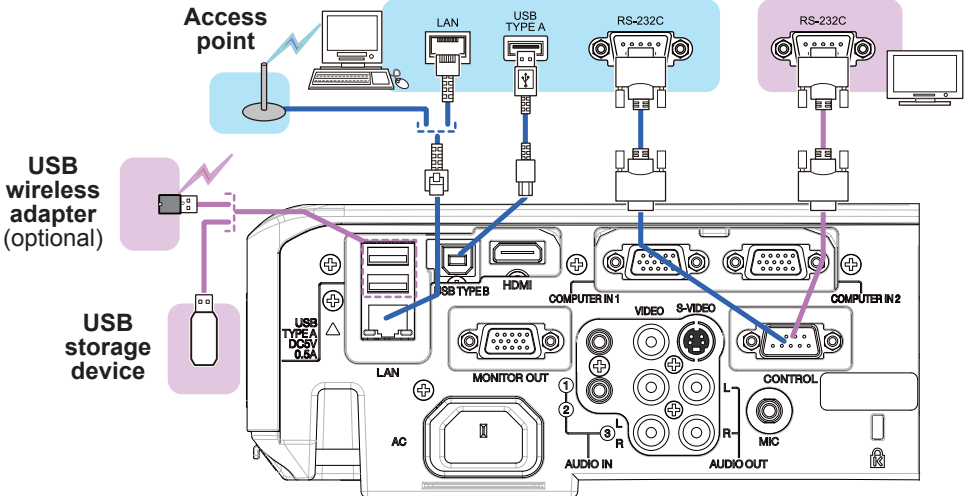



VCR/DVD/Blu-ray Disc™ player

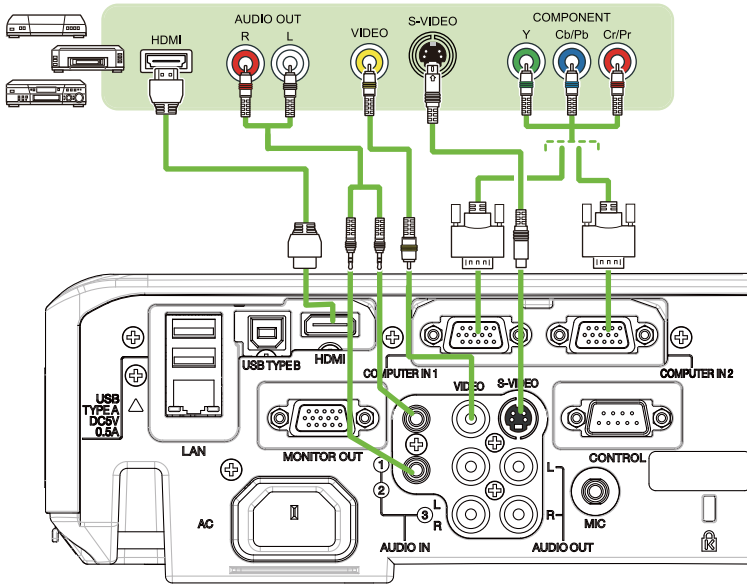

Speakers  
(with an amplifier)

Monitor

Microphone

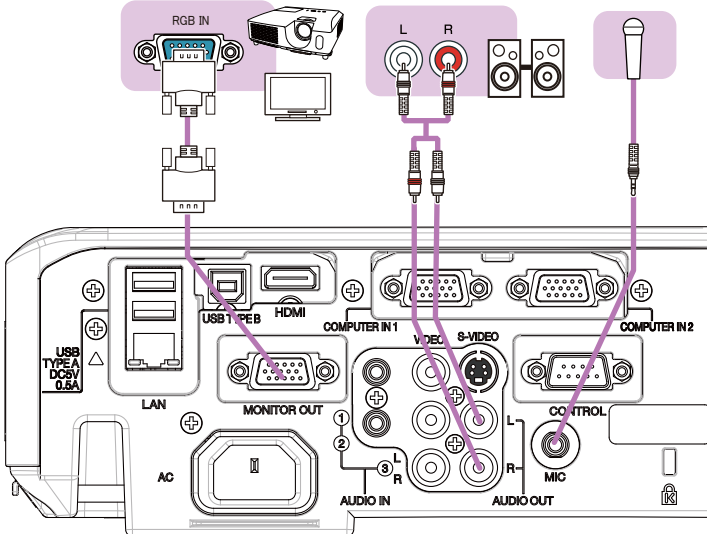

Future Model

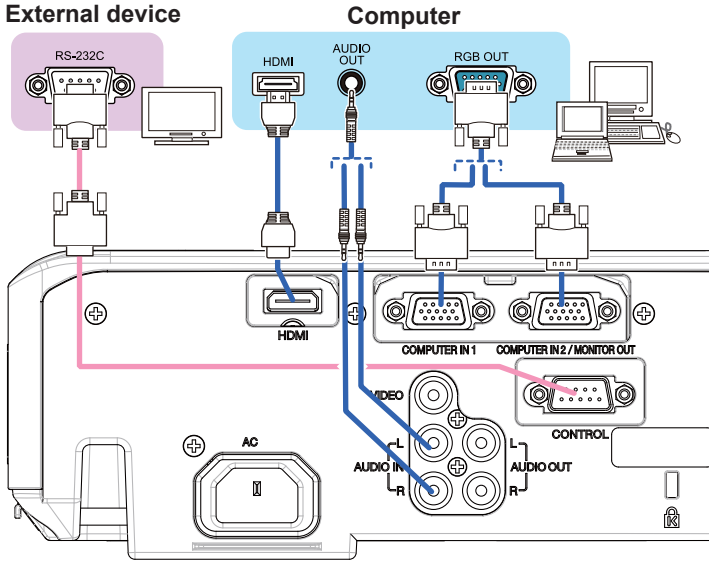

Future Model

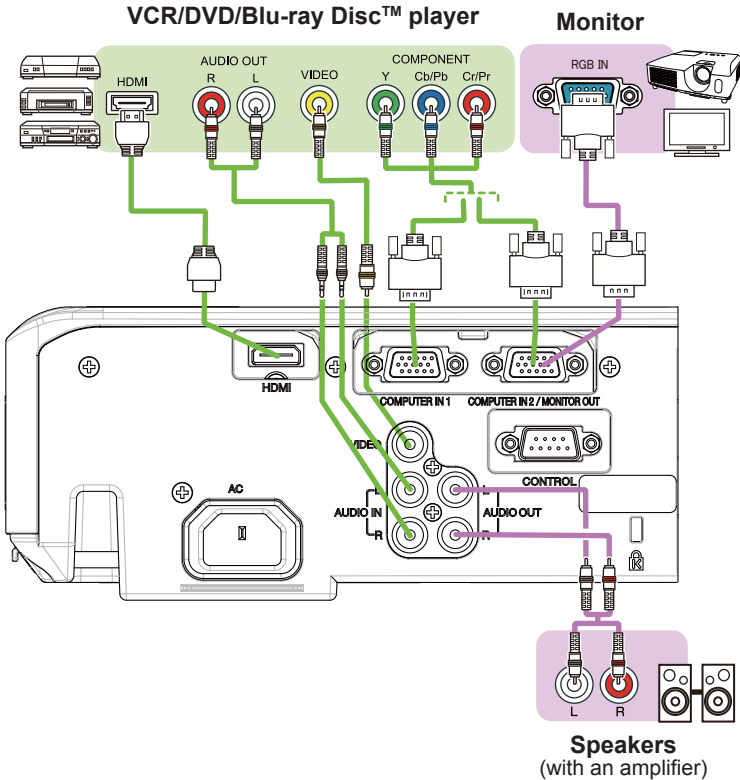

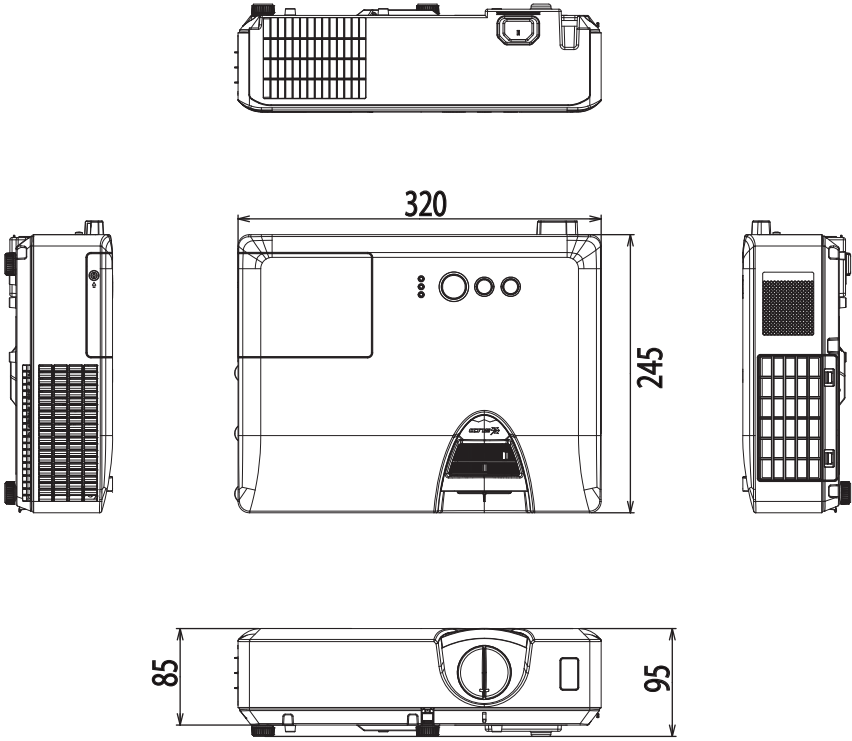

[unit: mm]

**DUKANE CORP AV SERVICE DEPT**

2900 Dukane Drive  
St Charles, IL 60174  
800-676-2487 / 630-762-4032  
Fax 630-584-5156  
avservice@dukane.com  
www.dukaneav.com